

# Lake Mareotis: Reconstructing the Past

Proceedings of the International Conference on the  
Archaeology of the Mareotic Region held at  
Alexandria University, Egypt, 5th-6th April 2008

Edited by  
**Lucy Blue**

assisted by  
Emad Khalil

BAR International Series 2113  
2010

Published by

Archaeopress  
Publishers of British Archaeological Reports  
Gordon House  
276 Banbury Road  
Oxford OX2 7ED  
England  
bar@archaeopress.com  
www.archaeopress.com

BAR S2113  
University of Southampton Series in Archaeology 2  
Series editor: S. Moser

*Lake Mareotis: Reconstructing the Past. Proceedings of the International Conference on the Archaeology of the Mareotic Region Held at Alexandria University, Egypt, 5<sup>th</sup>-6<sup>th</sup> April 2008*

© Archaeopress and the individual authors 2010

ISBN 978 1 4073 0654 4

Cover photo: The Kibotos or box-shaped harbour (Survey Site 09 of the Lake Mareotis Research Project) on the south shore of Lake Mareotis, August 2007 (photo: Athena Trakadas).

Printed in England by Blenheim Colour Ltd

All BAR titles are available from:

Hadrian Books Ltd  
122 Banbury Road  
Oxford  
OX2 7BP  
England  
bar@hadrianbooks.co.uk

The current BAR catalogue with details of all titles in print, prices and means of payment is available free from Hadrian Books or may be downloaded from [www.archaeopress.com](http://www.archaeopress.com)

# The Lake Structures at Taposiris

## Marie-Françoise Boussac & Mourad El Amouri

### Introduction

Among the harbours of Mareotis, which in recent years have been the subject of renewed attention, Taposiris on the north shore is of particular interest. Amongst many features of interest, the city offers the only example, besides that of Alexandria, of a closed basin which allows controlled maritime traffic management (Fig. 1). These structures were briefly mentioned at the beginning of the 19<sup>th</sup> century by Pacho, who in 1824 devoted a few lines to “the dam running from east to west (...) built in the south of the city”, a structure intended, he said, to prevent floods (Pacho 1827) and sketched by Coste<sup>1</sup> in 1820 (Fig. 2). Thereafter, Breccia (1914), De Cosson (1935: 110-111) (Fig. 3), Ochsenschlager (1979, 1999) and Rodziewicz (2002), amongst others, have pointed out the peculiarities of the closed basin, speculating on its chronology and its connection with the wall of the Barbarians which closes, to the west of the city, the very narrow spit of land that separates the Mediterranean from Lake Mareotis at this point, and its relation to the causeway which blocked the lake to the south. At some point in their use, both systems acted as locks and seem related, but we do not know if they are part of the same feature, nor do we know during which period they were used.

To answer these questions, the American mission from Brooklyn College carried out several soundings in 1975, during a one month campaign. Anxious to locate the harbour area,<sup>2</sup> Ochsenschlager worked on two sectors, north and north-west of the dug-out channel and the causeway. Neither gave the anticipated results: in the north (Zone A), an elevated area, interpreted as a lake front, proved to be an accumulation of rubble (waste from amphorae workshops, as shown thereafter by Empereur & Picon 1998). In the north-west (Zone C), American archaeologists concentrated their efforts on what initially seemed to be a warehouse along the shore. They described it as a platform which had been redesigned several times (the so-called *platform building*), they did not understand its function, but they dated it to the 3<sup>rd</sup> century AD. They also uncovered a sophisticated system of water tanks carrying water towards the harbour from a terrace further north. No research was published to specify the chronology, and no interpretation was suggested (unpublished).

When the French Archaeological Mission of Taposiris<sup>3</sup> was launched in 1998, it was determined that an understanding of the harbour system would be a research priority. What was the chronology of the currently visible structures? To which phases of the site did they correspond? Because of the dimensions of the harbour basin (the east-west artificial levee or causeway is about 1,700 m long), areas that were deemed likely to provide some answers with limited resources were selected for excavation, supplemented with an environmental study and geophysical survey. Since most of the data acquired has already been the subject of articles (Boussac 2007, 2009), this paper will briefly present the harbour structures and the conclusions reached concerning the southern causeway. The east side of the system will be the main focus as this gives the latest possible date for all the studied lake constructions.

### Overview of the Remains

The ancient city of Taposiris, located on the south side of the *taenia* ridge, is organised into three sectors linked by a network of north-south routes: the upper town with the Brescia terrace and the temple, the middle town, and the lower town on the shores of Lake Mareotis. To the west, the Wall of the Barbarians forms the western limit of the city (see Fig. 1).

The topographical survey of the lower town area carried out in 1999 and 2000 (Fig. 4), and supplemented in 2009, extends from the Wall of the Barbarians in the west to Plinthine in the east, and highlights the irregular outline of the lake shore. A partially anthropogenic spit of land (promontory) divides the lake shore into two marshy plains, one of which, to the east, forms a bay which is interpreted as a harbour basin.<sup>4</sup> This basin covers an area of approximately 8 ha and is closed off to the south by a causeway (approximately 1,700 m long), which extends east-west in the shape of a ridge, but it is not straight as the sketches of Coste (1820; see Fig. 2) or De Cosson (1935: 110; see Fig. 3) imply. It is also interrupted by at least six openings that may be deliberate or may be related to the disappearance of the retaining walls which in places supported the north slope of the causeway.

1. Thanks to the Bibliothèque Municipale à Vocation Régionale in Marseille, especially Noëlle Colombié, who allowed us to reproduce two sketches by Pascal Coste from their archives.

2. Thanks to the American mission, especially M. Venit, who shared their unpublished documentation (esp. *Preliminary Report of the 1975 season*).

3. Since 1998 La Mission Française in Taposiris Magna has been supported by the *Commission des fouilles* of the French Ministry of Foreign and European Affairs. Authorisation has been kindly given by SCA and we appreciate their assistance.

4. Analysis by C. Flaux, PhD Univ. Aix-Marseille, in 2008, in a PhD thesis on the geomorphology of Lake Mareotis.

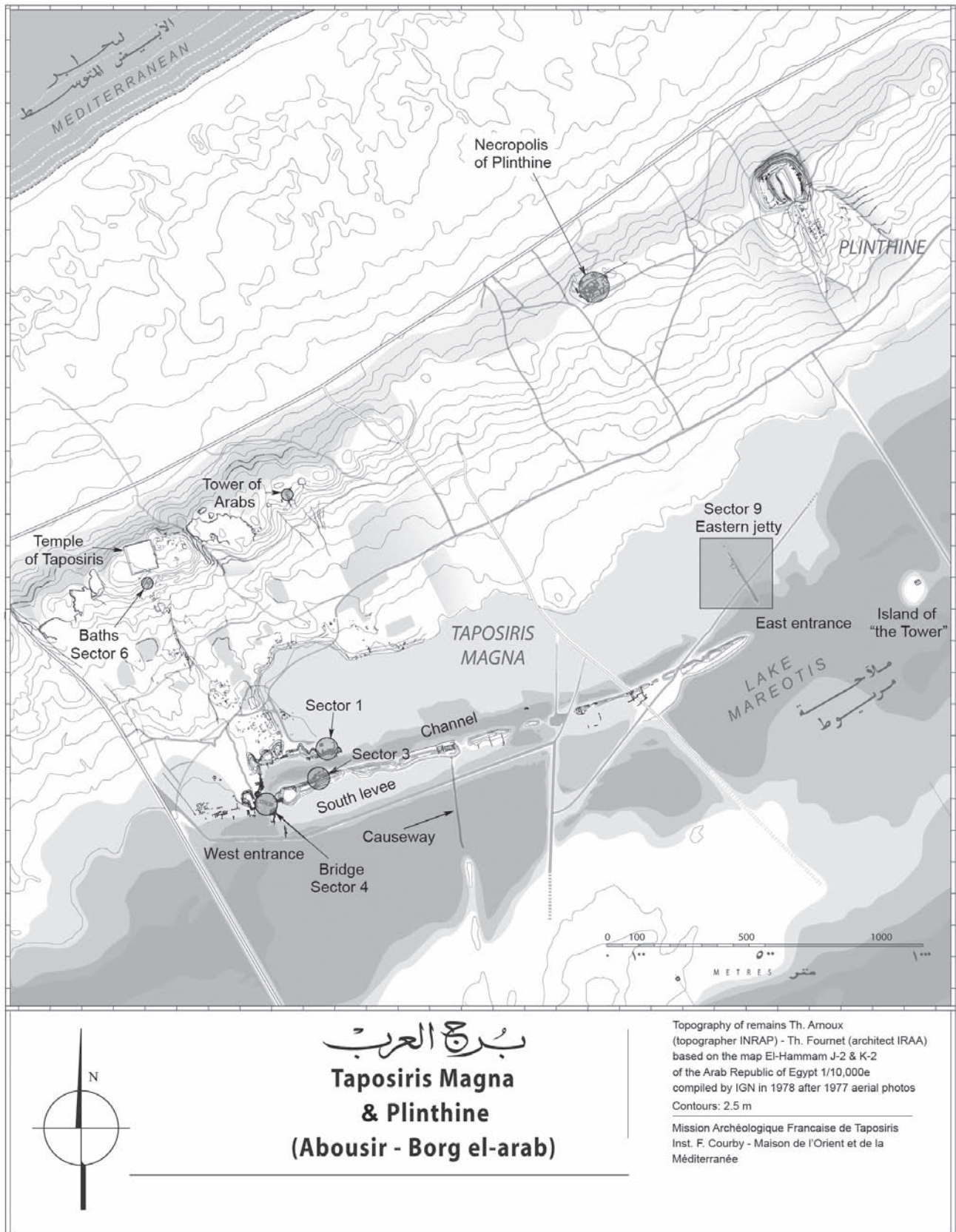

Fig. 1. General map of the site and location of areas under study at Taposiris Magna and Plinthine. © MAFT, French Archaeological Mission in Taposiris.



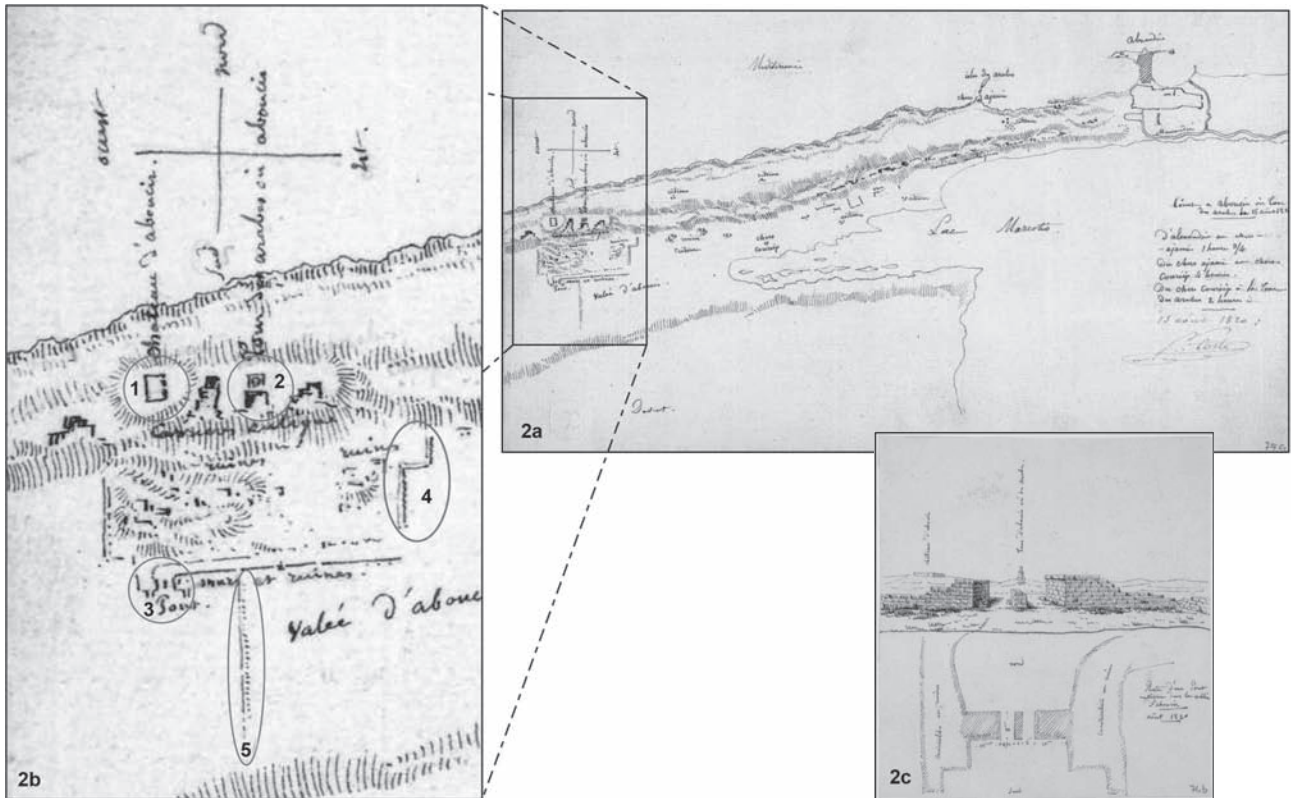

Fig. 2. Drawing by Pascal Coste, made in 1820. 2a: General plan of Alexandria to Abousir. 2b: Detail of plan showing the Temple of Taposiris (1), the Tower of Arabs (2), bridge (3), eastern jetty (4) and causeway across the lake from the levee to the south shore (5). 2c: Plan and isometric view (south) of the bridge of Taposiris. © BMVR

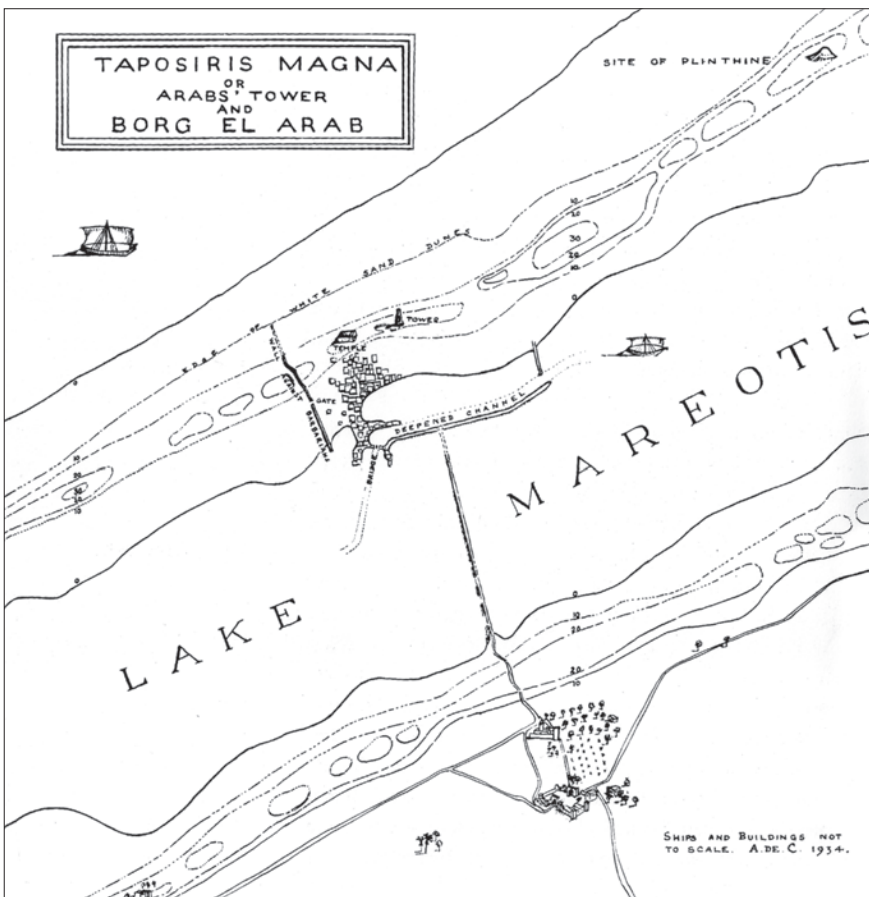

Fig. 3. Map of the remains of the ancient city of Taposiris by A. De Cosson, 1935.

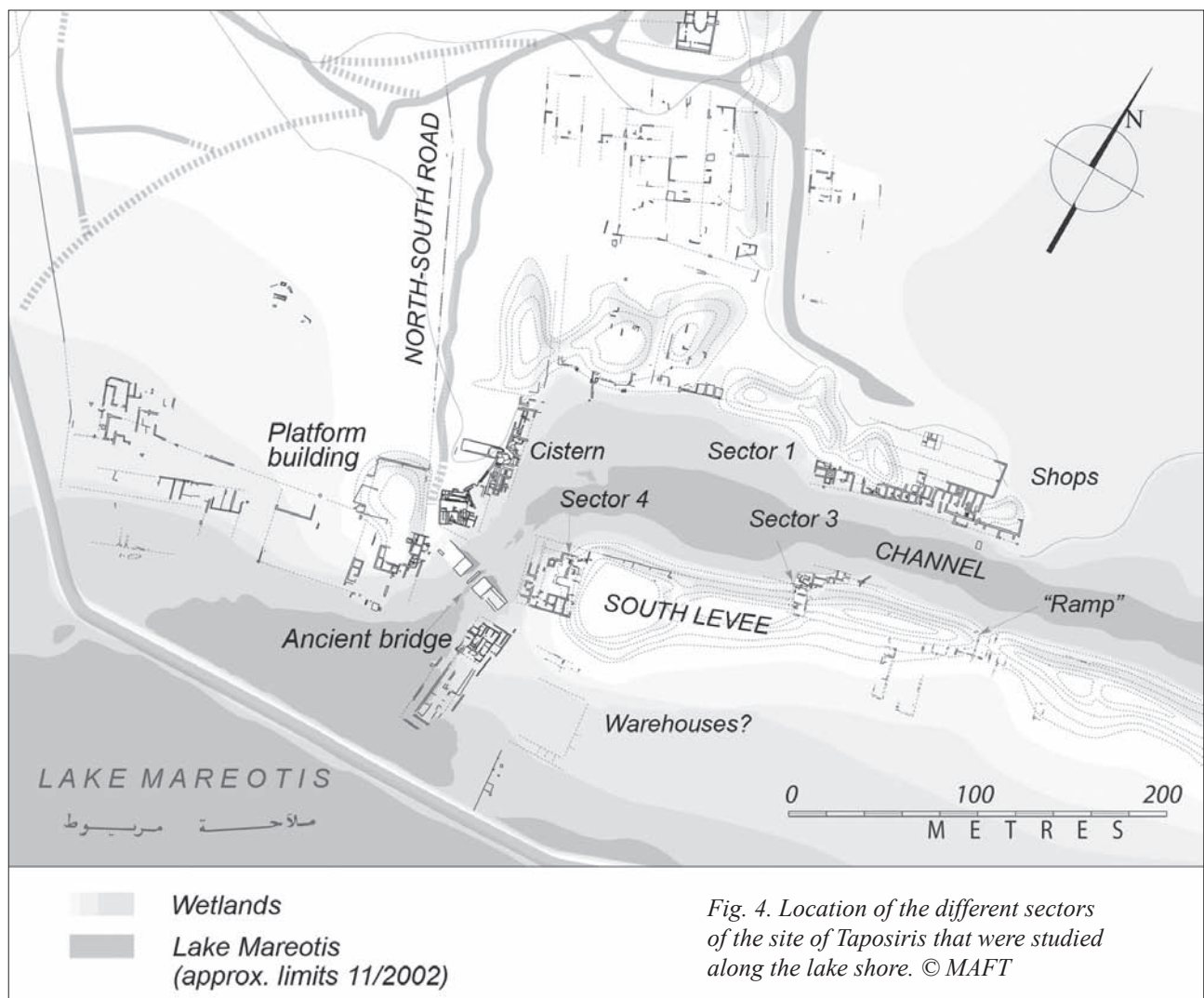

Fig. 4. Location of the different sectors of the site of Taposiris that were studied along the lake shore. © MAFT

Topographic mapping and geophysical survey revealed the density of structures in the lower town, briefly mentioned as “walls and ruins” by Coste (1820) and ignored by Breccia (1914).<sup>5</sup> Although the causeway that blocked the lake has virtually disappeared (only a stretch of about 10 m could be uncovered), its outlet was located near a warehouse built on the causeway. Most importantly, the geophysical survey revealed in the West Bay and south of the bridge many ruins which are currently silted over.<sup>6</sup> These results underscore the extent of changes in the landscape, the mobility of the shoreline and the extent of the harbour area.

### The Elements of the Lake System

#### *The Causeway and the Channel*

Several operations (1998, 2000-2005) were conducted at the west end of the causeway, on both sides of the channel and near the bridge, where the basin forms a bend: it

expands to the northwest to form a loop against which is aligned by a series of buildings, whose different orientations and especially superposition indicate different phases. This visible state has significantly altered the previous interpretation of the phases: the channel was dug in the first half of the 2<sup>nd</sup> century AD (Boussac 2009)<sup>7</sup> in a location where a densely occupied area was previously developed whose architectural design suggests prosperity. This area was used for storage and trade, judging from the quantity of imported amphorae material found there (Boussac 2009).<sup>8</sup> On the north shore (Sector 1) there is a row of shops, abandoned at the end of the Hellenistic period (un-recovered items left in place) perhaps as a result of flooding,<sup>9</sup> before the digging of the channel. On the other side of the channel (Sector 3), earth that had been dredged from the lake covered buildings last occupied at the end of the 1<sup>st</sup> century BC and which had been in use since at least the 2<sup>nd</sup> century BC. The excavated building has the same

5. Breccia 1914. He only mentions the 1 km-long dyke, running parallel to the hills, and a “fine bridge whose construction certainly dates to Roman times. It seems clear that the lake extended to Taposiris, and that the dyke blocked the water in a kind of harbour”.

6. Prospecting by C. Benech, CNRS. See the map in Boussac 2007: 452.

7. See the analysis by S. Marquié in Boussac 2009.

8. Boussac 2009 (see the appendix by S. Marquié and the study by K. Senol).

9. Study suggests during the 1<sup>st</sup> century BC: see the analysis by S. Marquié in Boussac 2009: 137.

architectural features as the north shops (foundations and architectonic elements in stone, mud-brick walls covered with a coating). It was supplied with drinking water by rainwater collected and discharged into a cruciform tank located to the north. The angle of the buildings on both sides of an east-west axis indicates the prior circulation of water in this area, which was later replaced by the channel. The level of the tank indicates that the site chosen to dig the channel was originally an area not liable to flooding.

The whole area was disrupted by major works after a period of stagnation and neglect. The objective was to create a navigation canal by digging a channel, and ensure access by strengthening and shoring the banks formed. The channel was dug and the waste was deposited to the north and south creating two sedimentary causeways, of unequal length but of a similar configuration – the causeway to the north extends for about 150 m, to the south for 1,700 m.

An anthropic embankment was formed by successive heaps of backfill piled up, stabilised by a gypsum screed. The most extensive works were carried out to the west, where the edge of the promontory needed to be cut back. This explains why there are only two artificial embankment slopes in this sector, to the north and the south, and why the causeway ends near the bridge at a height of some 5-6 m and then drops in irregular steps towards the east. The two sides are asymmetrical: the north slope, which follows the dug-out channel is steeper and supported by a series of retaining walls to prevent the collapse of the earth and therefore seal the passage, the south side has a shallower slope.

#### *The Bridge*

A dressed stone<sup>10</sup> bridge<sup>11</sup> guards the west entrance of the channel. Its present appearance has hardly changed since Coste's sketch in 1820 (see Fig. 2-c): 47 m long including the ramps, and 9 m wide. Its maximum height is 2.55 m. It consists of two massive abutments of equal length (6.02 m for the south abutment and 6.55 m for the north abutment). The space of approximately 8.35 m between the two abutments is divided by a narrower intermediate pier (1.20 m). This pier is off-centre compared to the axis of the abutments, thus forming two passages of different widths (4.10 m to the south and 3.05 m to the north) which only allowed access to the channel to small boats (Bougia 1996). Study of the structure leads to several conclusions. First of all, the bridge was probably supported by masonry vaults (Figs. 5-7).<sup>12</sup> The flatness of the natural terrain required the creation of a passage sufficiently high for the

harbour traffic to pass, while minimizing the size of the humpback bridge. This would partly explain the asymmetry of the two arches, with a humpback passage which best fits the top of the vaults, which are all of different widths and heights (approximately 4.5 m and 4 m).

Furthermore, the construction of the bridge can only be explained by the existence of the causeway and channel system. A limited investigation (6.2 m by 3.2 m) conducted in the foundation pebble bed (*radier*) of the north pier of the bridge, to the flood level of the lake, confirms that the construction of the bridge is contemporary with the digging of the channel, however it does not allow precise dating. Indeed, the stratigraphic study of this area shows that the bridge was built over a level that dates back to the Imperial Roman period; it confirms that the channel, the bridge and the closed harbour system can be dated to the Imperial Roman period.

#### *The East Part of the Lake System*

The lake basin is closed to the east by a built jetty, which was the subject of two campaigns in 2005 and 2006, following a preliminary phase of topographical mapping in 1999 and 2000. The cancellation of the following two campaigns (2008 and 2009), due to an exceptional rise in the water level, meant that certain points remain to be determined, in particular the chronology: while the date of abandonment is well attested by the coins and ceramics (first half of 7<sup>th</sup> century AD), uncertainties remain concerning the previous phases.

The jetty is located approximately 1,700 m to the east of the bridge (west entrance of the harbour basin) below the Temple of Taposiris. Between the end of the causeway and the tip of the jetty, there is an opening which is currently about 100 m wide. This probably allowed boats to enter the harbour basin from the east. We have not yet observed a structure that could act as a checkpoint like the bridge that closes access to the west or like the causeway running north-south which blocked the lake between the harbour complex and the southernmost bank (Boussac 2009).

Excavations have identified several structures: the jetty, which is interrupted by three openings – two flushes and a water supply channel – which cross its entire width; two basins, one square, the other in the shape of a hoop, located inside the dock and attached to the jetty, between the north flush and the water supply channel.

#### **The East Jetty**

The east jetty extends north-south and has a visible length of 230 m and a width varying of 5-6 m.<sup>13</sup> It ends in the lake and it is possible to follow its extent for a further

10. Rodziewicz (1998: 102) only mentions a "structure". In fact, the bridge was necessary to cross the channel for those coming from the south of the lake using the causeway and following the road north.

11. As is the case for most stone buildings in the region, it is calcarenite, white dune limestone, extracted from the quarries on the *taenia*.

12. This architectural analysis, and the model (Fig. 7) are the work of students at M2Pro Univ. Lyon II, especially R. Brunier and F. Jimenez, under the supervision of T. Fournet (CNRS, IRAA/HISOMA).

13. It is longer than the jetties built on the south shore at Marea (60 and 40 m long) at the site referred to as "Kibotos" (Blue & Ramses 2005: 10) and is similar to structures noticed during prospecting on an island of Mariout, at a site which played a major role in the management of lake traffic (*ibid.*, Sites 23, 12).





Fig. 5. View of the Taposiris bridge from north. © MAFT

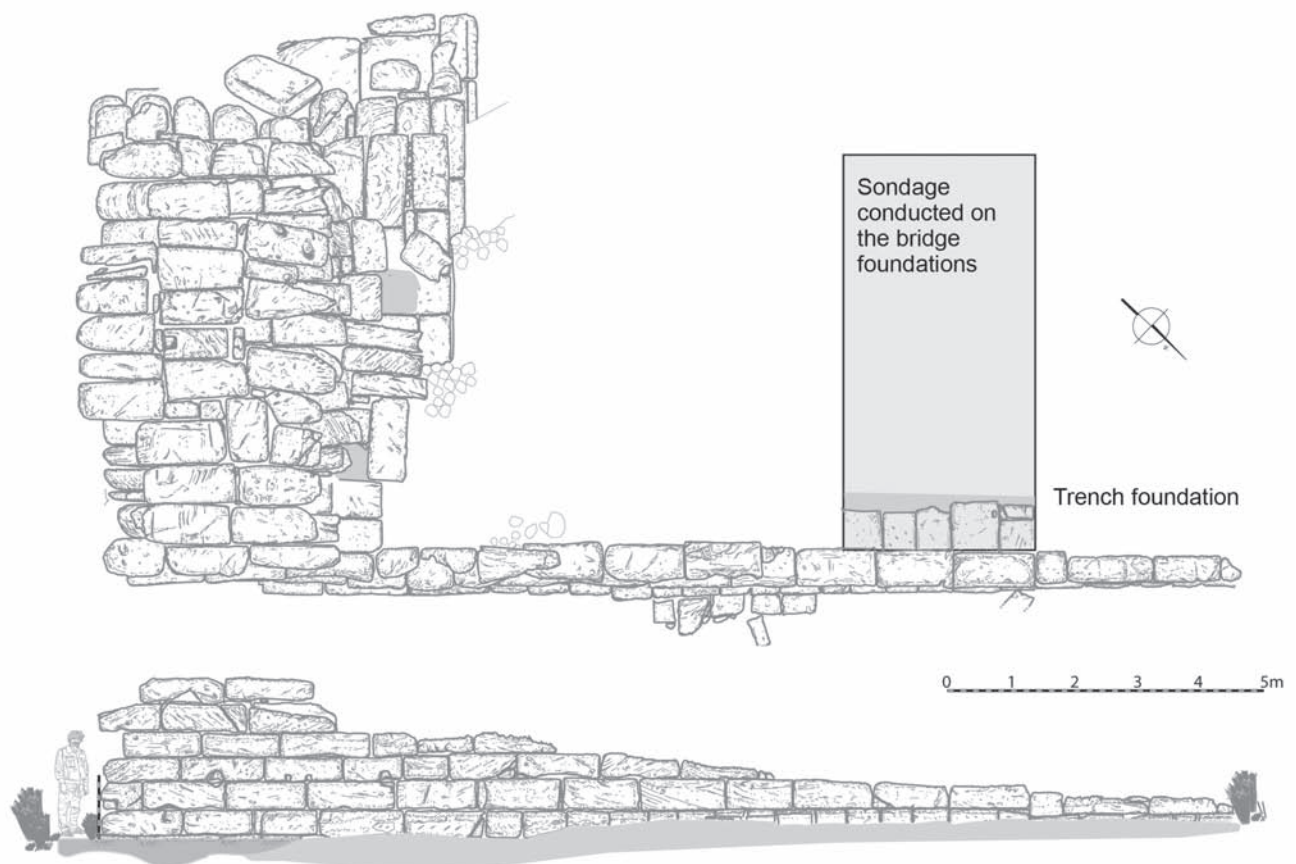
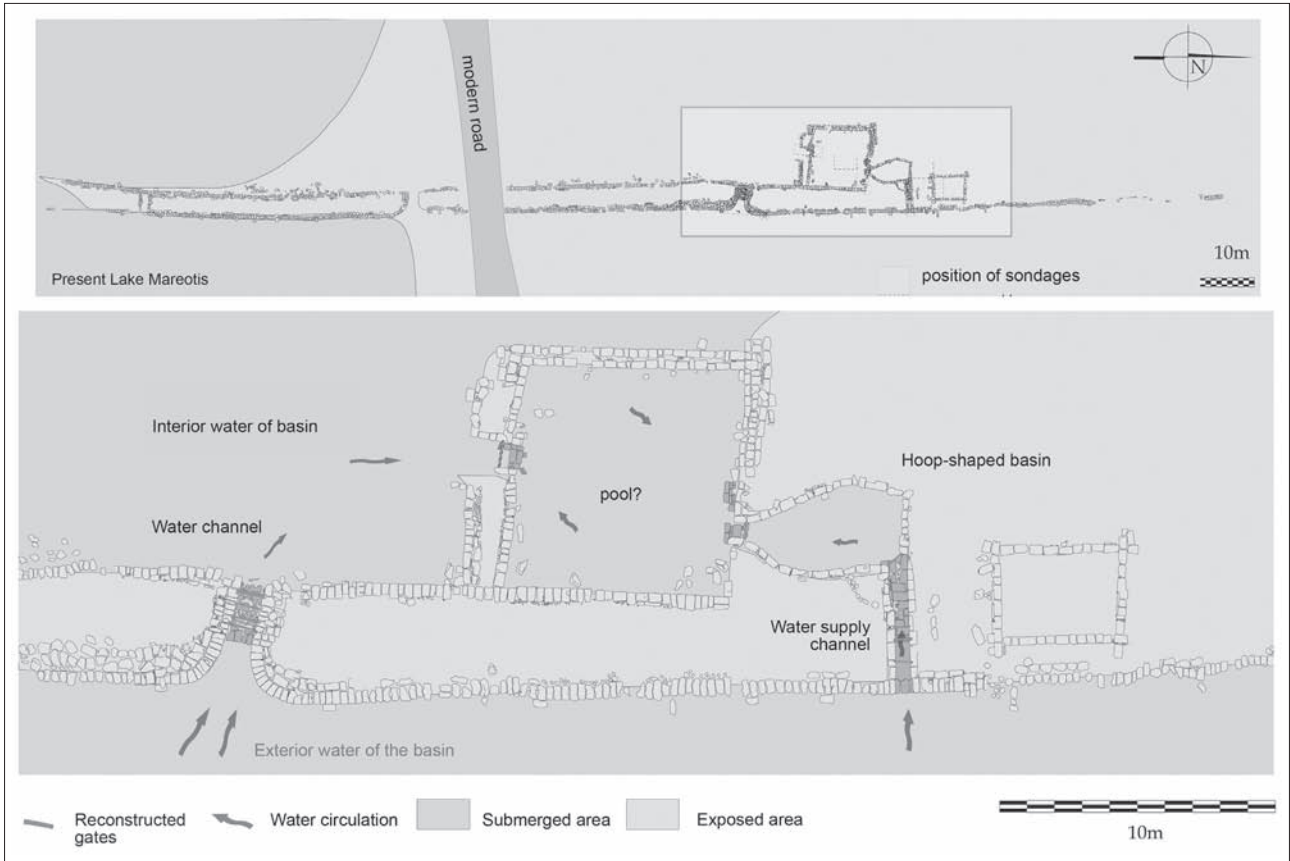

Fig. 6. (above) Plan and elevation of the north pile of the bridge, November 2004. Lay out, drawing and DAO by M. El Amouri. © MAFT



Fig. 7. (left) Model and reconstruction of the bridge in Taposiris Magna (students of the Master Pro-Lyon II). © MAFT





20 m or so under water (Fig. 8). To the north it gradually disappears first towards the west and then the east. This asymmetry could indicate that the point of attachment of the causeway on dry land is different than at the southern lake end from that at the lake end. Further north, the silting of the area and recent constructions prevent the correct reading of its route. Situated on the axis, about 50 m to the north, is a masonry structure (ST9001<sup>14</sup>) which may or may not be related to the jetty.

The jetty (Fig. 9) is built in blocks of regular size (0.50 x 0.20 x 0.25 m on average) arranged in headers, and the design is comparable to that of the harbour structures present at the neighbouring sites at Gamal and Quseir (Figs. 10 & 11). Excavated sections of the eastern jetty revealed four well preserved courses, and two additional courses which have now disappeared. Over its entire length, both sides of the jetty are punctuated with buttresses (Fig. 12). These 27 buttresses (16 on the east side and 11 on the west side) are maintained on several courses (three or four). Every second course has two headers while the alternate blocks are stretchers on their edge. They are on average 0.50-0.60 m wide and protrude by about 0.30 m. They stabilised the entire jetty, while encouraging micro areas of

Fig. 8. Overall plan and detailed outline of the eastern jetty. Lay out, drawing and DAO by M. El Amouri. © MAFT

Fig. 9. The southern end of the eastern jetty. View from north. © MAFT



14. An investigation was carried out in 2006 on this structure. The report on surface ruins shows an angle similar to that of the jetty. If it belongs to the jetty this would alter our interpretation of the extent of the closed harbour basin.



Fig. 10. Jetty at Gamal. View from north-west. © MAFT



Fig. 11. Jetty at Quseir. View from south-east. © MAFT



Fig. 12. Plan and elevation of the inner south face of the north flush and buttress. Lay out, drawing and DAO by M. El Amouri. © MAFT



Fig. 13. View of the north flush during excavation, from east.  
© MAFT



sediment accumulation, thus reducing the risk of sapping erosion due to currents and saline seepage.<sup>15</sup> It is telling that particular attention was given to the construction of the eastern face of the jetty where the buttresses are more numerous.

Indeed one notices a difference in treatment between the east side facing the open lake (the outside of the basin) that is subject to currents, and the west wall facing the interior of the basin. Investigation of the north flush revealed four courses of blocks to the east whereas there are only two to the west. A row of worked stones and a stone blockage line the east facing, but do not exist on the west side. In addition, the level of the upper beds of the blocks on the east side is slightly higher than that of the west side. These differences in the construction show that the jetty is a rampart against the open waters of the lake located to the east. To the west, the water in the basin is calmer and the construction of the jetty does not require these precautions.

#### *The North Flush*

There are two flushes, designed to bring as much running water as possible into the basin and thus prevent silting; one near the south tip of the jetty, the other to the north, more than 70 m from the present shore line, only the second flush has been the subject of investigation (Figs. 12 & 13). Its east opening is shaped like a funnel with two facing walls built in a quadrant. The west opening of this passage is straight and 1.2 m wide. The axis of the flush is not perpendicular to the jetty but shifted 15 degrees to the north, which probably gives an indication of the direction of the wind and/or dominant currents in the region during antiquity.

15. There is also a risk of erosion of the sides of the causeway facing the channel; this was prevented by the stone constructions, the ramp and the retaining wall.

In addition, the east part of the flush is designed in order to circulate as much (surface) fresh water as possible (McCann 2003: 32)<sup>16</sup> towards the interior of the harbour basin: a base of grey mortar<sup>17</sup> at the base of the projection formed by the paving of the western part, has a slope to the east which hinders the entry of sediment into the harbour basin, while allowing the passage of a stream of fresh water. The western part of the bottom of the flush, paved in worked stone, is thus located more than 0.40 m above the mortar.

Carved into the faces of the flush conduit on the paved western half, there are several vertical notches with corresponding horizontal grooves in the paving, which allow the recreation of the system of closing and filtering of the flush. It would appear that three of these locking systems could operate simultaneously. They probably held filter sluice gates or simple *martelières* type gates, which allowed the control of the flow of water according to currents and seasons while limiting the entry of sediments to the basin.<sup>18</sup> Two twin notches have no corresponding grooves which implies the redesign of the paving and locking systems. A lightweight and retractable system to cross the flush probably existed for passage across the jetty, but no archaeological evidence shows its design.

16. McCann 2003: 32; the author states that the constant flow of water helps control the temperature, oxygenation and salinity of the water, adding that the proximity of a source of fresh water is an advantage.

17. Grey mortar seems to have been chosen for the bed of the east entrances of the north flush and the water supply channel. However, pink hydraulic mortar is used around the upper areas of the north flush and water supply channel.

18. Does this system indicate seasons with high levels of sedimentation? Are these seasons connected to Nile floods? Indeed, the Nile is joined to Lake Mareotis via canals but underground water must also have raised the level of the lake during floods, bringing a great deal of sediment.

### Fish Farming Systems

One of the most interesting findings is the discovery of an original system for breeding/keeping fish. At the current stage of excavations, this consists of a water supply channel which crosses the jetty, a hoop-shaped basin and a fish-tank attached to the jetty inside the harbour basin (see Fig. 8). This complex, which has possibly not been entirely uncovered, and which shows signs of repairs, indicates intensive fish farming (Lafon 2001: 161, 165), i.e. breeding in artificial pools. From a typological point of view, these installations built on the lake are one of the types of fish farming installations analyzed in various recent studies, mostly devoted to the Roman world (Kron 2008): basins built by digging in the 'sand' and 'masonry work' (Type III) (see below Lafon 2001: 171). Plato tells us that fish farming was practiced on a large scale on the banks of the Nile and papyri from the Hellenistic and Roman eras reveal much information about *ichthyotropheia*, *piscinae* and other *apodocheia* (Chouliara-Raios 2003; Brewer & Friedman 1989) of which our system is an example. The region of Canope is home to several *piscinae* dug out of the rocks, some of which have long been known (Brescia 1926; Abd El-Maguid forthcoming) but the installation uncovered in Taposiris is unique to this day around the shores of Lake Mareotis (Lafon 1998: 573).<sup>19</sup> However, the association of harbour installations and fisheries is not surprising and the facilities found at Taposiris are similar for example to those found at Kenchreai dating to around AD 80 (Scranton, et al. 1978):<sup>20</sup> basins are created near the jetty (Rothaus, et al. 2008; Lafon 2001: 162)<sup>21</sup> and connected to one another and with the sea through channels.

#### *The Water Supply Channel*

The water supply channel crosses the jetty perpendicularly over its entire width (Figs. 14 & 15). This channel is 0.70 m wide, 6 m long and 0.85 m deep at the point where the third course is still preserved. It consists of a small decantation basin, a ledge and three closing systems with notches carved opposite one another, 0.50-1 m apart: they were used to create a kind of lock, like in Kenchreai (Scranton, et al. 1978).<sup>22</sup>

One of these systems of notches still has its corresponding grooves cut in the bottom of the paving blocks (Fig. 16). This is the first paving block (to the east) and acts as a dam to stop the sediment accumulated in the small decanta-

tion basin. As with the flush, the grooves holding the filter sluice gates or locking *martelières* were modified during the rehabilitation of the water supply channel.

The walls of the water supply channel are built in worked stones bound with pink mortar. The blocks which form the entrance to the channel are chamfered to facilitate the entry of water. It is a simple funnel system. At the entrance, the bottom of the channel, like the bottom of the flush, is made of grey mortar sloping towards the east.

The water supply channel, like the flush, might have been covered by a crossing system, but we did not find any trace of it, although we noticed the last course on its north wall was slightly battered.

The western part of the south interior face of the channel (Fig. 14) appears to have undergone repair with small unworked stones which contrast with the usual blocks of worked stone of the walls of the channel. Other repairs are visible in the south wall of the hoop-shaped basin.

The meticulous cleaning of the water supply channel led to the discovery of seven coins wedged between the paving stones of the channel, and thus protected from the cleaning work (Field Unit [FU] 9240). Five of them belong to the Later Roman Empire (AE4) and two are Byzantine *dodekanoummia* of the 6<sup>th</sup>-7<sup>th</sup> century AD, including one dated to Heraclius (AD 610-641).<sup>23</sup> Thus, the water supply channel must have functioned at least from the 4<sup>th</sup> century to the 7<sup>th</sup> century AD.

Its period of abandonment is suggested by traces of blocking up. Chamfered blocks the same size as those still in place, and a block with a groove identical to that found on the blocks still in place, were discovered during excavations. These blocks thus come from the courses of the water supply channel. The chamfered blocks were placed at the entrance of the water supply channel to block it: they fit perfectly in the entrance of the water supply channel while keeping one layer horizontal, indicating that they were probably deliberately placed there. The backfilling of the channel thus seems a deliberate action indicating the stopping of the water supply or even of fishing, but ensuring the continued functioning of the jetty.

#### *The Hoop-shaped Basin*

The west end or exit of the water supply channel flows into a hoop-shaped structure (about 6 x 3 m) the base of which is paved (Figs. 8, 17 & 18). It is built in blocks of worked stone, arranged in a single row and preserved to two or three courses. The blocks are arranged in stretchers and their bases are covered with a hydraulic coating that forms a slight slope on the inside edge of the basin (see Fig. 18). This poorly preserved coating is only applied at the junction between the base pavement and the elevation.

19. Lafon 1998: 573, n. 3, notes that coastal speculation has caused the disappearance of many installations in the western Mediterranean over the past fifty years. Lake Mareotis is also threatened by intensive property speculation: during our first works on the east jetty area, it was divided up into plots of land, shown by boundary makers.

20. Scranton, et al. 1978. Their construction dates back to around AD 80.

21. Also see Lafon 2001: 162, n. 89, for Cosa: the author notes that in the port of Cosa, "canals joining the lagoon which has various dams, flow directly into the port, and form part of the same project".

22. Scranton, et al. 1978. Note the presence of several sluices per channel, necessary to form intermediary basins and fish traps: the dimensions of the basins (1 x 0.7 m) are similar to those found at Taposiris.

23. Study by T. Faucher, Appendix 2, *infra*.



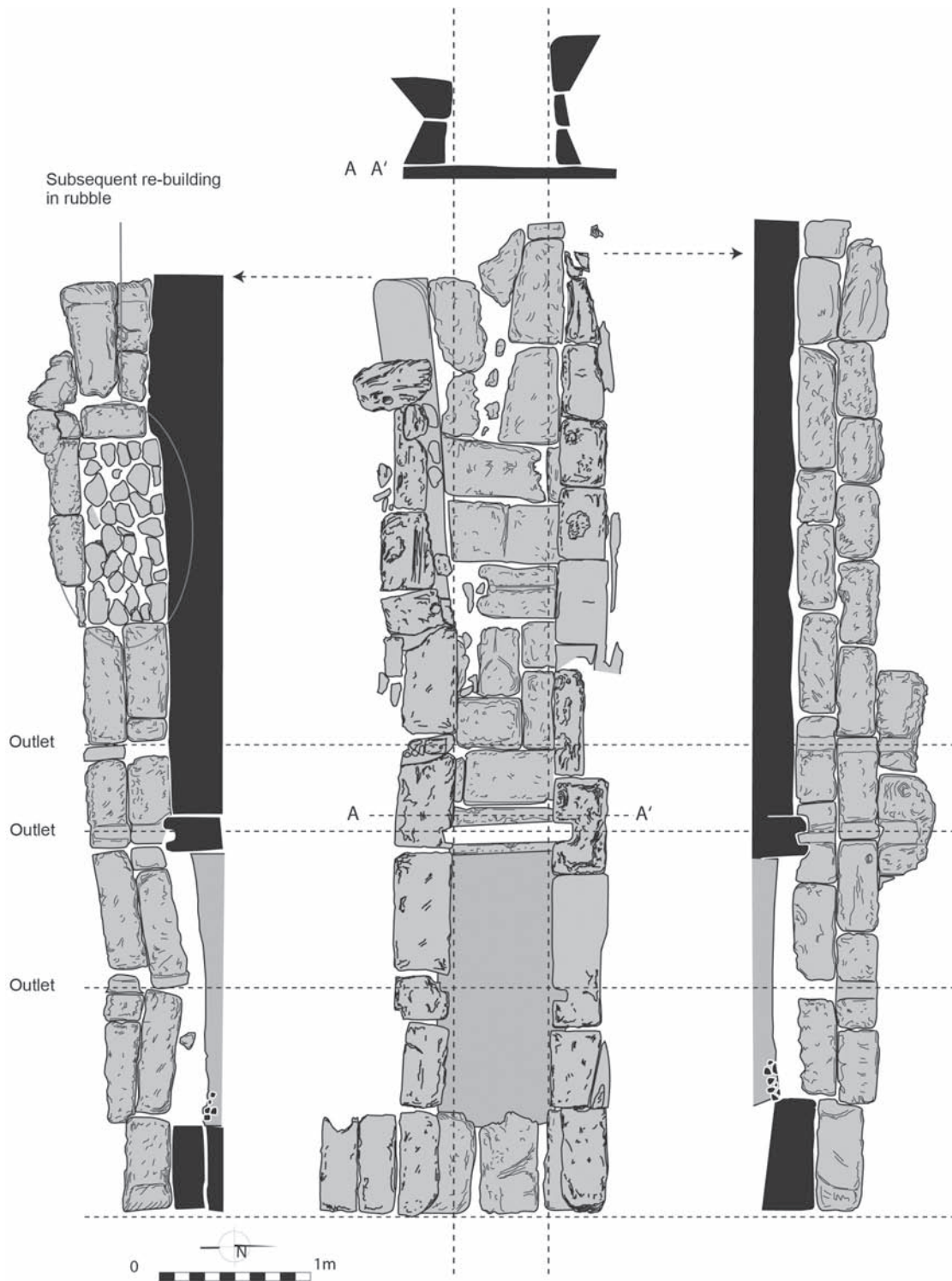

Fig. 14. Lay out, elevations and sections of north and south walls of the water supply channel through the eastern jetty. Lay out, drawing and DAO by M. El Amouri. © MAFT

The hoop-shaped basin, fed with water through the supply channel, is closed by a double sluice gate system, to the north-east and south: to the north-east, vertical and horizontal grooves were cut into the blocks forming the junction between the channel and the basin. To the south, the funnel-shaped end is fitted with the same system, indicating the method of control of the flow of water into the fish-tank, a large square structure enclosed by walls with double facing (Fig. 19). The junction was also de-

signed so as to create a slope down towards the fish-tank basin.

The north wall of the basin is an extension of the north wall of the water supply channel and seems to be a renovation or addition. Indeed, this wall is not linked to the channel and is built with smaller, roughly hewn stones, some of which are reused. Perhaps the link with the channel did not initially exist, at least in this form.



Fig. 15. Water supply channel through the eastern jetty opening into the hoop-shaped basin. View from east. © MAFT

Fig. 16. Grooves and notches in the water supply channel. View from north. © MAFT



24. Leatham & Hood 1958-59: 265: n. 8, concerning the need for a flow of fresh water into the fish tanks; the authors cite Q. Hortensius criticising M. Luculus whose fish tank does not have enough.

25. Sciallano (1997: 17) notes bronze sluices with holes, like those recommended by Columella (viii.17,6) because they are fine nets which allow water to pass through while trapping the fish (Leatham & Hood 1958-59: 265, n. 9). But other systems exist in wood or composite (wooden frame and metal grid for example), or in stone like at Mochlos (Leatham & Hood 1958-59: 275 and plate 63(a)).

### *The Fish-tank*

The fish-tank is a square basin whose interior dimensions are about 8 m x 8 m. It features walls angled north-south and east-west, all of different form. The west face of the east jetty serves as its east wall. The northeast corner of the basin corresponds to the end of the west face of the jetty. Investigations carried out on the extension of this face showed that no repairs had been made at this location and that the jetty had its original form.

It appears that the south and west walls of the basin were entirely built under water. The south wall of an average width of 1.5 m, consists of two parallel faces built in stone and filled with green clay sediment (FU 9221 to the east and FU 9225 to the west). This wall has an opening, built on at least two courses and equipped with a sluce gate system to control the flow of water. The proximity of the flush installed in the jetty provides a fresh water supply to this southern sluce gate (Leatham & Hood 1958-59: 265).<sup>24</sup> The position of this pool is therefore also chosen because of the flow of fresh water into the harbour basin.

### *Sluce Gates and Water Flow*

A system of fresh water flow was set up between the various structures composing this fishery. The flow or the blocking of water, or at least of fish in the case of filter sluce gates, is ensured by a system of sluce gates or *martelières* type gates. These are all designed in the same way: the vertical grooves cut in the facing blocks allow their positioning across passages, while horizontal grooves cut in the paving slabs ensure a good grip. Some of these gates must have let water filter through to ensure a good regeneration of water in the fish tank. However, no archaeological evidence indicates their construction material.<sup>25</sup> The size – between 0.10-0.20 m wide for the different grooves in the facing or paving blocks – suggests that at least the external framework of the sluce gates was made of wood. They may have been solid and entirely made of wood, or with openings, made with a wooden frame and metal grid.

The water from outside enters from two openings located to the south and north of the whole system:

- In the south, fresh water arrives through the flush located in the jetty. It enters the harbour basin and indirectly feeds the fish tank by the passage located in its south wall. It is closed by a sluce gate installed upstream of the paving inclined towards the fish-tank.
- In the north, the water supply channel feeds fresh water into the hoop-shaped basin. The arrival of water is regulated by four successive sluce gates, which leave water to flow towards the hoop-shaped basin while preventing fish from escaping. The frequency of these sluce gates also facilitates maintenance work (cleaning, repairs, etc.). A rearrangement may explain the position of the sluce gate located to the west end of the water supply channel, which opens directly onto the northeast corner of the hoop-shaped basin. The space partitioned off by this sluce gate and the one before it, is the largest in the channel. The last sluce



*Fig. 17. View of the hoop-shaped basin, the water supply channel and the fish-tank. View from north.*  
© MAFT



*Fig. 18. The pavement in the hoop-shaped basin. View from north.*  
© MAFT



*Fig. 19. The opening between the hoop-shaped basin and the fish-tank. View from south-west.*  
© MAFT



gate is fitted across and at an angle to the axis of the channel and is therefore directed towards the centre of the loop, which may also be due to a repair. This all suggests that this sluice gate dates from a later date.

The passage between the hoop-shaped basin and the fish-tank, which is also blocked by a sluice gate, is equipped with the same system. Thus, all these adjustments help to prevent the basins from silting up while encouraging the constant flow of water, which is a key element for the survival of fish in captivity (Sciallano 1997: 17). Furthermore, the shallow and muddy bed is the perfect environment for fish farming (Lafon 2001: 159).<sup>26</sup>

### *The Fish*

The fish species identified in the Field Unit related to the use of the fish tank (FU 9215 and 9220 in particular) at this stage of the study are mainly marine fish or fish which live in brackish water (Lafon 1998: 575).<sup>27</sup> A preliminary diagnosis carried out using photographs to visually identify the species<sup>28</sup> in advance of a comprehensive study, indicates the presence of sturgeons and garfish (*Belone belone*). At the present stage of work, all the excavated structures seem too small to have housed real breeding farms (Guest-Papamanoli 1986: 301). We suppose it was for the temporary storage of live fish, like at Kenchreai.

### **Chronology**

In the east sector of the harbour system, the various phases of installation of the fish farming facilities and the chronological link between the visible system and the construction of the jetty are currently difficult to specify. Whereas the west harbour system (bridge and channel) can be dated to the 2<sup>nd</sup> century, the state of visible installations in the east remains unclear: the traces of repairs in the system between the hoop-shaped basin and the channel do not make it possible to date its construction, nor that of the visible jetty. All that can be said about the jetty is that it cannot be later than the 4<sup>th</sup> century.

The presence in the filling of the south wall of the fish tank, of amphorae remains LRA 1 and fragments of containers LRA 4, some of which are dated between the last third of the 5<sup>th</sup> century and the middle of the 6<sup>th</sup> century,<sup>29</sup> provides an approximate dating for its construction (*terminus post quem*).

However, ceramic and monetary data provide consistent dates for the last phase of use of the system: ceramic material discovered in the last archaeological layer (FU

9216/9220) filling the hoop-shaped basin, principally uncovered storage containers (Amphorae LRA 1, 4 LRA and LRA 5/6), indicate a final phase of use of the fish tank during the first half of the 7<sup>th</sup> century. This hypothesis is supported by the absence of Egyptian amphorae Egloff 167, well documented on Alexandrine and Mariout sites from the mid-7<sup>th</sup> century. Similarly, among the coins wedged between the paving stones on the channel bed, there are two Byzantine *dodekanoummia* from the 6<sup>th</sup>-7<sup>th</sup> century AD, including one dated to Heraclius (AD 610-641; see Appendix 2).

This last phase of use of the system also relates to the last phase of the warehouse excavated in 2000 on the causeway, strategically located near the causeway which crosses the lake (Boussac 2009: 129). The finds included three Heraclius *dodekanoummia* and late amphorae (LRA 1, 4, 5/6 and 7).

The intensity of lake activities during late antiquity corresponds to what the texts and archaeology tell us of the role of Taposiris during this period: the identification in 2009 of late antique thermal baths in the middle town, comparable to those at Marea, further strengthens these findings. However, nothing is yet known about the Hellenistic installations, although we are collecting more data on the city from the 2<sup>nd</sup> - 1<sup>st</sup> century BC, and even from the end of the 3<sup>rd</sup> century: the temple, according to Dr. Z. Hawass, was founded by Ptolemy IV, suggesting that the city's development is linked to (or accelerated by) this royal intervention (Hawass 2008: 29). However, it implies nothing about lake constructions. Nevertheless, in the west, the area covered by the backfill from the digging of the channel in the first half of the 2<sup>nd</sup> century AD (Boussac 2009: 137-141), revealed many imported amphorae (Rhodians and Cnidians) which show the intensity of trade from the outside via Alexandria, at least between the mid-2<sup>nd</sup> century BC and the early 1<sup>st</sup> century BC. Although their fragmentation prevents us from being precise, the site where these containers were found, close to the shore, suggests that we are not dealing with land transport, but transport on the lake (Bernard 2009). This storage area suggests specific installations of which nothing remains.

Nothing is known about the structures from the beginning of the Imperial era: in describing Taposiris as the gate (*eisbolè*) of Egypt in his *Letter to the Alexandrians* in AD 41, Claudius refers to the fiscal and military role of the city, which was probably associated with specific facilities (Boussac 2001). However, the oldest phase of the harbour that we were able to identify is that which includes the digging of the channel, which is not earlier than the first half of the 2<sup>nd</sup> century AD (Boussac 2009).<sup>30</sup> If one considers that the warehouses and the fish farming facilities operated until the 7<sup>th</sup> century, then one understands to what extent the intermediate stages of evolution still escape us.

26. Lafon 2001: 159: "breeding requires very sheltered water with a shallow sandy or silty bed: lagoon shores provide the most favourable environment".

27. Lafon 1998: 575. The author insists that brackish water is favourable for breeding as it helps the development of young fish and attracts fish.

28. S. Cravhino, pers. comm. (PhD Univ. Aix-Marseille I).

29. Study by D. Dixneuf, IFAO. See Appendix 1, *infra*.

30. See S. Marquié's study in Boussac 2009.



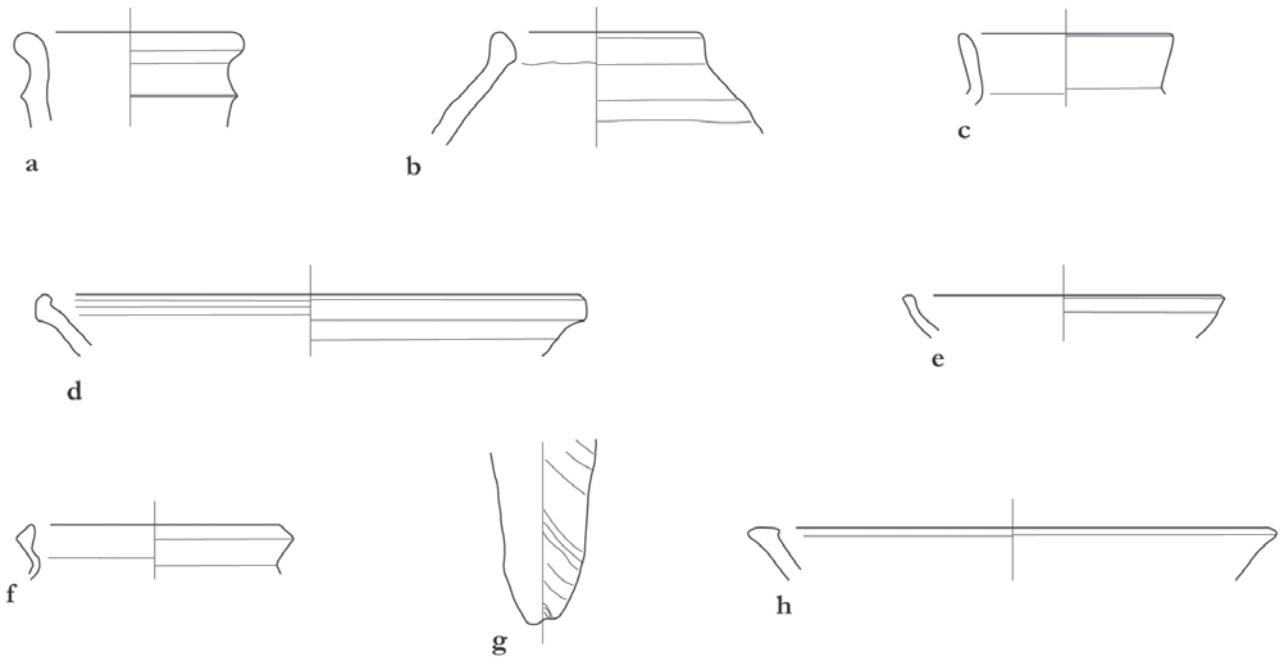

Fig. 20. Main types of ceramics found in Taposiris Magna (Sector 9) during the Late Roman era.

## Appendix 1 The Ceramics in the Harbour Area: the Eastern Jetty (Sector 9)

Delphine Dixneuf, IFAO, Cairo

Archaeological excavations carried out in the area of the harbour basin, and more precisely on the eastern jetty (Sector 9) uncovered a few ceramics often very fragmentary and eroded. They amount, except for fragments of bodies, to more than 243 sherds, or 119 individuals.<sup>31</sup> However, most of them, i.e. more than 66% of the ceramic assemblage (NMI = 79), consist of storage and transport containers, both locally produced and imported, characteristic of the Late Roman period, dating which is confirmed by the study of coins by Thomas Faucher (see Appendix 2 this paper).

### 1. The Imported Amphorae and Ceramics

#### • The LRA 1 Amphorae<sup>32</sup>

Among the imported containers at the site, LRA1 amphorae are the second most common type (NMI = 10). This evidence finds parallel in all Late Roman Egyptian sites, from the second half of the 4<sup>th</sup> century until the mid-7<sup>th</sup> century, or slightly beyond. These jars were produced on the southern coast of Turkey, Cyprus and Rhodes (Em-

pereur & Picon 1989: 236-243),<sup>33</sup> and were used for the storage and transport of wine, and possibly olive oil. Fragments found in Area 9 (Fig. 20, a) are related to the B1 type according to the classification of Late Eastern Amphorae established by Dominique Piéri (2005). This form, generally attributed to the 6<sup>th</sup> and 7<sup>th</sup> centuries, is characterized by “thick rolled rim (an edge to mid-neck recalls the moulding of the previous type)” (Piéri 2005: 75). The handles are now almost unribbed. The clay is rather dense and a general trend emerges: marl clay, fine texture and a red to light brown section. Inclusions are of large size, and consists mainly of grains of quartz, some white and sometimes red.

#### • The LRA 4 Amphorae

LRA 4 productions from southern Palestine represent 32.7% of NMI, i.e. 39 individuals. The general form of these amphorae (Fig. 20, b) is morphologically close to Piéri’s type B and dated between the middle of the 6<sup>th</sup> and the 7<sup>th</sup> century (Piéri 2005: 106-107). Many of these amphorae have a sandy and gritty marl clay, with a medium dense fabric and contain several grains of quartz, some grey and white particles of various sizes. The section is usually homogeneous, from buff to orange. Shaping and surface treatment are quite coarse, and clay accretions are frequently observed on the neck. The macroscopic charac-

31. All the sherds are analysed using the criteria of the clay and shape to determine the MNI – Minimum Number of Individuals – by context first, then for the whole sector. Rims, handles, bottoms and bodies fragments were counted. NMI or the global minimum, estimated for the sector, is the highest number among the different morphological features, except the bodies. Regarding the amphorae, the number of handles is divided by two.

32. The term Late Roman Amphorae (LRA 1 to 7) refers to the typology of Late Eastern amphorae established by Riley 1981: 85-122 for the material found in Carthage.

33. However, only two workshops have been excavated in Cyprus: Paphos and Ziggy. See Demesticha & Michaelides 2001: 289-296; Demesticha 2003: 469-476.

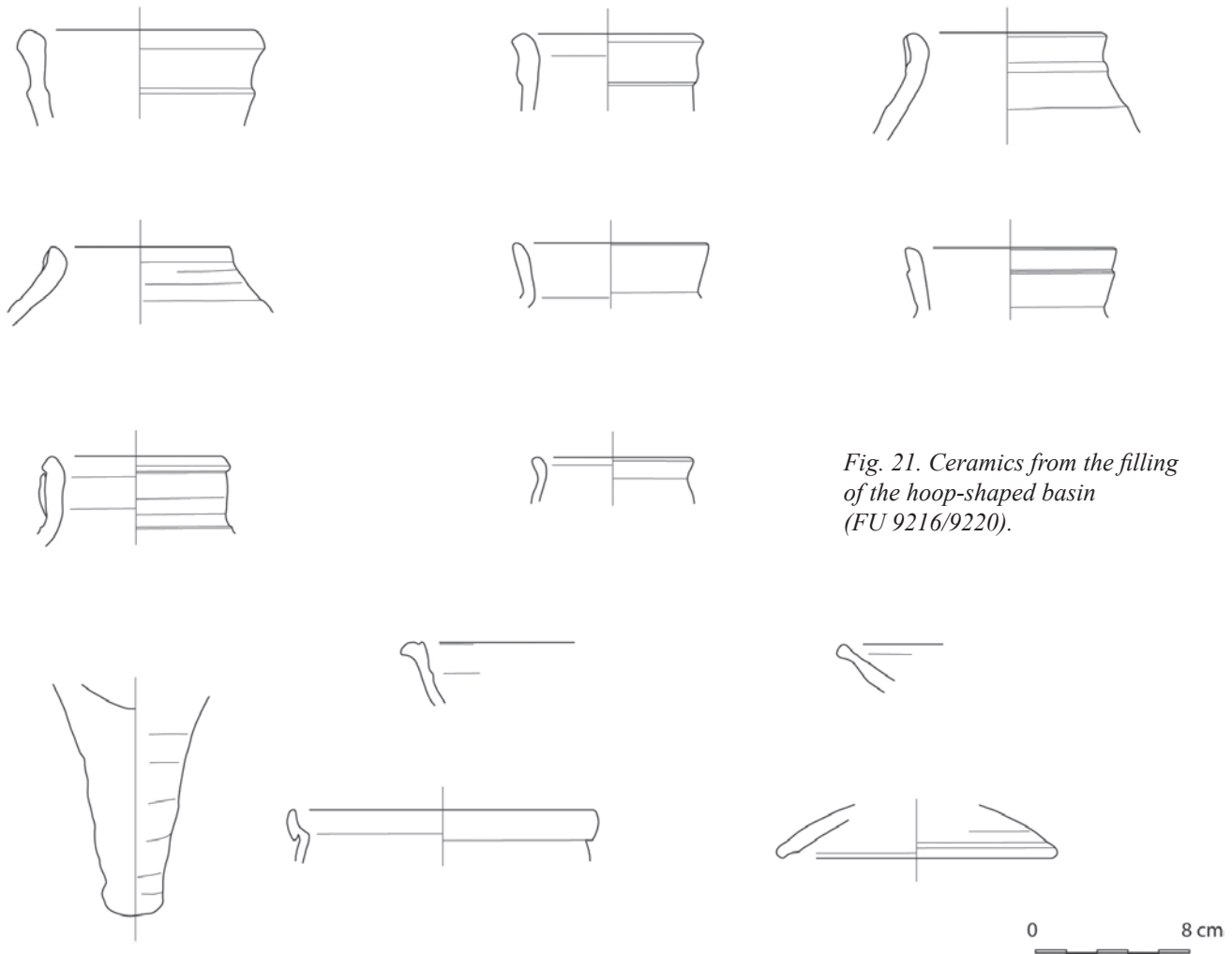

Fig. 21. Ceramics from the filling of the hoop-shaped basin (FU 9216/9220).

teristics help us to locate the region of production in southern Palestine, especially in the area of Gaza, Ashkelon and Ashdod.<sup>34</sup> However, it is interesting to note the similarity between the clay of Palestine amphorae and ceramics manufactured from Mareotic clays.

In addition to transport containers of types LRA 1 and LRA 4, a few fragments of amphorae and ceramics could not be identified with the exception of a fragment of the body of an African *sigillata* and two elements of Cypriot *sigillata*. It is a ring-base low bottom and a rim which seems to correspond to Hayes' 9B shape and date from late 6<sup>th</sup> to late 7<sup>th</sup> centuries (Hayes 1972: 378-382).

## 2. Egyptian Production

### • Egyptian Production in Marl Clay

With the exception of 12 residual fragments (NMI = 6) of AE 3 amphorae, marl clay productions are mainly illustrated by globular or ovoid containers, more commonly referred to as “bag-shaped”, which were produced in many eastern Mediterranean sites, more specifically in the Levant, Palestine and Egypt (NMI = 15). Containers found in

Sector 9 are morphologically close to Piéri's “bag-shaped amphora, type 4” (Piéri 2005: 117, fig. 76). It is a globular amphora of small size; the neck is short and cylindrical or convex, ending with a small round and/or flared rim, with a sinuous profile (Fig. 20, c). On the Kellia site, Françoise Bonnet-Borel sets the appearance of these containers during the second quarter of the 7<sup>th</sup> century (Bonnet 1983: 442), however it is not impossible that they started as early as the late 6<sup>th</sup> century. They are still present during the Fatimid era, with no major change in the shape (Vogt 1997: 256, 258). As regards the identification of site productions, only one group of clay could so far be identified: marl clay, medium density fabric, sandy; the section is usually brown to buff. The inclusions consist of several grains of quartz, some grey and white particles of various sizes. The macroscopic examination of the amphorae, which can logically be assumed to be local or at least regional productions, questions the distinction between Palestinian and Mareotic productions. Thus, two hypotheses can be put forward: they are either Egyptian or Palestinian containers exported with the LRA 4 Amphorae. Only macroscopic and petrographic analysis would answer this question.

Quite logically, common ware is illustrated primarily by marl clay products, some with alluvial content, manufactured without any doubt in Mareotic workshops, on the site

34. For a state of question on LRA 4 amphorae and bibliography, see Dixneuf 2005: 54-62.

or at least nearby (Majcherek 2001: 60-64). The shape repertory includes dishes with rounded rim (Fig. 20, d), some of them with a high-placed carination in their external wall, cups with flattened carination (Fig. 20, e), fragments of storage jars and vases for liquids and some cooking pots (Fig. 20, f).

• *Egyptian Production in Alluvial Clay*

These productions from the Delta and/or the Nile Valley are only a small part of the ceramics: 17 individuals, i.e. 14.2% of all ceramics identified. Apart from some fragments of three AE amphorae, a bottom and a carinated shoulder of a wine LRA 7 container (Fig. 20, g) have been identified. Common wares are illustrated by bowls (Fig. 20, h),<sup>35</sup> dishes with rounded rims, and two cooking pots with a C shaped rim dated at the Kellia to the 7<sup>th</sup> century (Egloff 1977: 103, Pl. 52 (no. 4 & 6, type 138) and to the first half of the 7<sup>th</sup> century in Baouit.<sup>36</sup>

### 3. The Assemblages

• *The Fishery Complex*

The southern wall of the fish-tank consists of two faces with a filling of green clay (FU 9221/9225). Few ceramics were found in the filling but they provide a chronology for the construction of the fish-tank and probably the whole complex. They consist of bodies of some LRA 1 amphorae and fragments of LRA 4 containers including a bottom and a rim close to Piéri's B1 form; this form is dated from the last third of the 5<sup>th</sup> to the middle of the 6<sup>th</sup> century (Piéri 2005: 105-106).

The ceramic material discovered in the last archaeological layer (FU 9216/9220) of the hoop-net shaped basin consists mainly of storage containers, i.e. LRA 1, LRA 4 and LRA 5/6 Amphorae, and fragments of common wares which might be linked to food consumption by the fishermen (Fig. 21). Thus, this material attests to a final phase of use of the basin during the first half of the 7<sup>th</sup> century. This hypothesis is confirmed by the absence of Egyptian Egloff 167 amphorae, well documented on Alexandrine and Mariout sites from the mid-7<sup>th</sup> century onwards.

To conclude, the study of Late Roman pottery discovered at Sector 9 offers some interesting insights into the commercial activities and trade in the harbour area, which was the western customs of Alexandria on the Mareotis Lake since Roman times if not before. In addition to local marl clay productions, the repertory includes several imports, mainly of wine containers from the eastern Mediterranean and some ceramics from the Delta and/or the Nile Valley, reflecting the economic vitality of the region and fishing activities.

## Appendix 2 The Coins from Sector 9

Thomas Faucher, Sorbonne, Paris

A number of coins whose study is currently in progress were found during the excavations in Sector 9. After some preliminary restoration, it is possible to make a few remarks here.

Most of the coins belong to the Late Roman and Byzantine periods. No coin dating to earlier than the 4<sup>th</sup> century AD was found, whether in or out of stratigraphical context. All the Late Roman coins (12 items) are small denominations (*ca* 10 mm) commonly called AE4 (AE for bronze and 4 for the size). The identification of these coins is not possible until the restoration is completed but it is unlikely that more information about the type and date of these coins will be gained, for two reasons. First, the proximity of the lake water has facilitated the corrosion of these coins which are often in poor condition. Secondly, these coins, commonly dated to the 4<sup>th</sup>-5<sup>th</sup> centuries, were often molded coins, unlike struck coins, produced more or less legally to overcome the lack of currency. This technique allowed for the production of a large number of coins in a short time, but makes coins almost illegible, even when they are just produced. Therefore, it is logical that their circulation and subsequent deposition in the ground has erased any information.

In addition to these Roman coins, there are also three *dodekanoummia* (a coin of 12 *noummion*) easily recognisable by the letters IB on the reverse, produced using the same molding process. Among the latter, were identified one coin from the reign of Justin I (518-527) and a second from the reign of Heraclius (610-641). It is difficult to give a precise date for molded coins since the coin might have been molded later than the date of production of the model.

The Alexandrian excavations emphasised the importance of this phenomenon whose magnitude was often underestimated in the past. This manufacturing technique is attested as early as the Ptolemaic era and continues in Roman and Byzantine periods despite its apparent restricted use during the Early Roman Empire; in any case it is difficult to say if it was outlawed by the state and successfully repressed.

When fully restored, the coins from Sector 9 will hopefully provide a more precise datation and help discern more accurately the different periods of use of the eastern jetty area.

35. One should tentatively compare this rim fragments with a series of dishes found at Kellia and dated to the first half of the 7<sup>th</sup> century; however these are of alluvial clay and with a painted decoration on white slip. See Bonnet 1994: 378-379, fig. 231 (No. 138).

36. Unpublished material.

**Bibliography**

- Bernard, S.G., 2009, Alexandrian *Tainiai* and Land Traffic Patterns: A Note on the Amnesty Decree (*P. Teb.* I 5) in Light of the Topography. *Zeitschrift für Papyrologie und Epigraphik* 168: 265-270.
- Blue, L., & Ramses, S., 2005, Lake Mareotis Research Project – Preliminary Report from Pilot Survey August 2004. *Newsletter of the Archaeological Society of Alexandria* 15 (February): 5-16.
- Bonnet, F., 1983, Poteries, verres, monnaies, décors et inscriptions. In R. Kasser & J.-M. Alès (eds.), *Survey archéologique des Kellia (Basse-Égypte). Rapport de la campagne 1981*: 423-480. Louvain.
- Bonnet, F., 1994, Le matériel archéologique récolté en 1977, 1982 et 1983 aux Qouçouër-Roubâ'iyât. In R. Kasser & F. Bonnet (eds.), *Explorations aux Qouçouët er-Roubâ'iyât. Rapport des campagnes 1982 et 1983*: 349-406. Louvain.
- Bougia, P., 1996, *Ancient bridges in Greece and coastal Asia Minor*. PhD thesis, University of Pennsylvania.
- Boussac, M.-F., 2001, Deux villes en Maréotide: Taposiris Magna et Plinthine. *Bulletin de la Société française d'égyptologie* 150: 42-72.
- Boussac, M.-F., 2007, Recherches récentes à Taposiris Magna et Plinthine, Égypte (1998-2006). *Comptes rendus des séances de l'Académie des inscriptions et belles-lettres (janvier-mars)*: 445-479.
- Boussac, M.-F., 2009, Taposiris Magna: la création du port artificiel. In F. Dumasy & F. Queyrel (eds.), *Archéologie et environnement dans la Méditerranée antique*: 123-142. Paris.
- Breccia, E., 1914, *Alexandria ad Aegyptum*. Bergamo.
- Breccia, E., 1926, *Monuments de l'Égypte gréco-romaine, I: Le rovine e i monumenti di Canopo*. Bergamo.
- Brewer, D.J., & Friedman, R.F., 1989, *Fish and fishing in ancient Egypt*. Warminster.
- Chouliara-Raios, H., 2003, *La pêche en Égypte à la lumière des papyrus grecs*. Ioannina.
- De Cosson, A., 1935, *Mareotis: Being a Short Account of the History and Ancient Monuments of the North-Western Desert of Egypt and Lake Mareotis*. London.
- Demesticha, S., 2003, Amphora production on Cyprus during the Late Roman Period. In C. Bakirtzis (ed.), *De Rome à Byzance; de Fostat à Cordoue. Évolution des faciès céramiques en Méditerranée (V<sup>e</sup> – IX<sup>e</sup> siècles), actes du VII<sup>e</sup> congrès international sur la céramique médiévale (Thessalonique, 11-16 octobre 1999)*: 469-476. Athènes.
- Demesticha, S., & Michalides, D., 2001, The Excavation of a Late Roman 1 Amphora kiln in Paphos. In E. Villeneuve & P.M. Watson (eds.), *La céramique byzantine et proto-islamique en Syrie-Jordanie (IV<sup>e</sup> - VIII<sup>e</sup> siècles AD. J.-C.)*. Actes du colloque d'Amman (3-5 décembre 1994): 289-296. Beirut.
- Dixneuf, D., 2005, Production et circulation des biens à Gaza durant l'Antiquité tardive: le témoignage des amphores. In C. Saliou (ed.), *Gaza dans l'Antiquité Tardive. Archéologie, rhétorique et histoire*: 54-62. Salerne.
- Egloff, M., 1977, *Kellia. La poterie copte. Quatre siècles d'artisanat et d'échanges en Basse Égypte*. Genève.
- Empereur, J.-Y., & Picon, M., 1989, Les régions de production d'amphores impériales en Méditerranée orientale. *Amphores romaines et histoire économique: dix ans de recherche. Actes du colloque de Sienna (22-24 mai 1986)*: 236-243. Rome.
- Empereur, J.-Y., & Picon, M., 1998, Les ateliers d'amphores du Lac Mariout. In J.-Y. Empereur (ed.), *Commerce et artisanat dans l'Alexandrie hellénistique et romaine. Actes du colloque d'Athènes, organisé par le CNRS, le Laboratoire de céramologie de Lyon et l'École française d'Athènes, 11-12 décembre 1988*: 75-88. Athens, Paris.
- Guest-Papamanoli, A., 1986, Archéologie, ethnographie ou ethnoarchéologie des ressources marine de sites cotiers. Le cas de la pêche aux muges dans les lagunes de la Grèce Occidentale. In F. Gerard (ed.), *VI<sup>èmes</sup> rencontres internationales d'archéologie et d'histoire d'Antibes. L'exploitation de la mer de l'Antiquité à nos jours. II: La mer comme lieu d'échanges et de communication*: 281-303. Valbonne.
- Hawass, Z., 2008, In search of Cleopatra and Mark Antony. *Horus* (August/September): 26-29.
- Hayes, J.W., 1972, *Late Roman Pottery*. London.
- Kron, G., 2008, Reconstructing the Techniques and Potential Productivity of Roman Aquaculture in the Light of Recent Research and Practice. In E. Hermon (ed.), *Vers une gestion intégrée de l'eau dans l'empire romain*: 175-185. Rome.
- Lafon, X., 1998, Piscinae et pisciculture dans le bassin occidental de la Méditerranée. *Journal of Roman Archaeology* 11: 573-582.
- Lafon, X., 2001, *Villa Maritima, recherches sur les villas littorales de l'Italie romaine (3<sup>ème</sup> s. av. J.-C. / 3<sup>ème</sup> s. ap. J.-C.)*. Rome.
- Leatham, J., & Hood, S., 1958-59, Submarine Exploration in Crete, 1955. *The Annual of the British School at Athens* 53-54: 263-280.
- El-Maguid, A., forthcoming, Maamourah Surveys: Preliminary report. In H. Tzalas (ed.), *Tropis VIII: Eighth conference on ship construction in antiquity, Hydra, Greece, August 2002*. Athens.
- Majcherek, G., 2001, Marea 2001: Note on the Pottery. *Polish Archaeology in the Mediterranean* 13: 60-64.
- McCann, A.-M., 2003, *The Roman Port and fishery of Cosa, a short guide*. Rome.
- Ochsenchlagel, E.-L., 1979, Taposiris Magna: 1975 season. *First International Congress of Egyptology*: 503-506. Berlin.
- Ochsenchlagel, E.-L., 1999, Taposiris Magna. In K.A. Bard (ed.), *Encyclopedia of the Archaeology of Ancient Egypt*: 759-761. Oxford.
- Pacho, J.-R., 1827, *Relation d'un voyage dans la Marmarique et la Cyrénaïque*. Paris.
- Piéri, D., 2005, *Le commerce du vin oriental à l'époque byzantine (V<sup>e</sup> – VII<sup>e</sup> siècles). Le témoignage des amphores en Gaule*. Beyrouth.



- Riley, J.A., 1981, Pottery from the Cisterns 1977.1, 1977.2 and 1977.3. *Excavations at Carthage 1977 conducted by the University of Michigan* 6: 85-122.
- Rodziewicz, M.D., 1998, From Alexandria to the West by land and waterways. In J.-Y. Empereur (ed.), *Commerce et artisanat dans l'Alexandrie hellénistique et romaine. Actes du colloque d'Athènes, organisé par le CNRS, le Laboratoire de céramologie de Lyon et l'École française d'Athènes, 11-12 décembre 1988*: 93-103. Athens, Paris.
- Rodziewicz, M.D., 2002, Mareotic harbours. In C. Décobert (ed.), *Alexandrie médiévale* 2: 1-22. Le Caire.
- Rothaus, R.M., Reinhardt, E.G., & Noller, J.S., 2008, Earthquakes and Subsidence at Kenchreai: Using Recent Earthquakes to Reconsider the Archaeological and Literary Evidence. In W.R. Caraher, L. Jones Hall & R.S. Moore (eds.), *Archaeology and History in Roman, Medieval and Post-Medieval Greece: Studies on Method and Meaning in Honor of Timothy E. Gregory*: 53-66. Aldershot.
- Sciallano, M., 1997, *Poissons de l'antiquité*. Catalogue d'exposition, 1<sup>er</sup> avril-31 août 1997. Musée d'Istres.
- Scranton, R., Shaw, J.W., & Ibrahim, L., 1978, *Kenchreai Eastern Port of Corinth*, Vol. I. Leyde.
- Vogt, C., 1997, Les céramiques ommeyyades et abassides d'Istabl'Antar-Fostat: traditions méditerranéennes et influences orientales. In G. Démians d'Archimbaud (ed.), *La céramique médiévale en Méditerranée. Actes du VI<sup>e</sup> congrès de l'AIECM2 (Aix-en-Provence, 13-18 novembre 1995)*: 243-260. Aix-en-Provence.