

OXHIDE INGOTS, COPPER PRODUCTION, AND THE MEDITERRANEAN  
TRADE IN COPPER AND OTHER METALS IN THE BRONZE AGE

A Thesis

by

MICHAEL RICE JONES

Submitted to the Office of Graduate Studies of  
Texas A&M University  
in partial fulfillment of the requirements for the degree of

MASTER OF ARTS

May 2007

Major Subject: Anthropology

OXHIDE INGOTS, COPPER PRODUCTION, AND THE MEDITERRANEAN  
TRADE IN COPPER AND OTHER METALS IN THE BRONZE AGE

A Thesis

by

MICHAEL RICE JONES

Submitted to the Office of Graduate Studies of  
Texas A&M University  
in partial fulfillment of the requirements for the degree of  
MASTER OF ARTS

Approved by:

Chair of Committee,	Cemal Pulak
Committee Members,	Shelley Wachsmann
	Christoph Konrad
Head of Department,	David Carlson

May 2007

Major Subject: Anthropology

## ABSTRACT

Oxhide Ingots, Copper Production, and the Mediterranean Trade in Copper and

Other Metals in the Bronze Age. (May 2007)

Michael Rice Jones, B.A., Boston University

Chair of Advisory Committee: Dr. Cemal Pulak

The production and trade in copper and bronze was one of the major features of the complex societies in the Near East and Mediterranean during the third to first millennia B.C. While finished metal objects are common finds from the period, ancient metal ingots and hoards of scrap metal, as well as archaeological evidence of metallurgical activities, are often more important sources of information for how ancient technology and trade functioned. Shipwrecks, particularly those found off the coast of Turkey at Uluburun and Cape Gelidonya, as well as mining and smelting sites in the Mediterranean region, provide invaluable information on the production and trade of copper and tin, the main ingredients of bronze. In this thesis, I examine the evolution of the copper trade in the eastern and central Mediterranean, particularly during the Late Bronze Age, when ‘oxhide’ ingots were widely exported. Finds of oxhide ingots have increased dramatically in recent years, and no synthesis of all of this newly available evidence is currently available. I attempt to analyze this new evidence in relation to older finds and research, with a particular focus on the cargo of the Uluburun shipwreck, the largest collection of Bronze Age metal ingots from a single site in the Mediterranean. The history of oxhide ingot production is complex, but by the Late Bronze Age Cyprus was supplying much of the copper used to neighboring regions, with revolutionary effects on societies in Cyprus and elsewhere.

The archaeological evidence shows that oxhide ingots are early examples of a standardized industrial product made for export by emerging state-level societies during the second millennium B.C. and fueled the development of international trade, metallurgical technology, and complex social institutions in a variety of Mediterranean societies from Egypt and the Levant, Greece, Cyprus, to Sardinia in the central Mediterranean.

## ACKNOWLEDGMENTS

I would like to thank my committee members, Dr. Cemal Pulak, Dr. Shelley Wachsmann, and Dr. Cristoph Konrad. Cemal Pulak and George Bass' work on the Uluburun shipwreck first stimulated my interest in the topic of the metals trade in the Bronze Age Mediterranean several years before I enrolled in Texas A&M, and their publications on Bronze Age Mediterranean shipwrecks and Bronze Age trade have been extremely valuable in researching this thesis. I am particularly indebted to Dr. Pulak, my committee chair, for giving me the opportunity to travel to Turkey in the summers of 2003 and 2004 and from June to December of 2005 to assist in several research projects, including the study of the copper ingots from the Uluburun shipwreck. This experience has been invaluable in understanding the Uluburun site, the literature on Bronze Age metals, and the problems associated with reconstructing the metals trade in the Bronze Age.

I would like to thank Shelley Wachsmann for his enthusiastic and imaginative approach to teaching about ancient trade and seafaring in the Mediterranean. Two of Dr. Wachsmann's books, *Aegeans in the Theban Tombs* and *Ships and Seafaring in the Bronze Age Levant*, have also been particularly valuable reference works for this thesis.

Dr. Pulak has also provided access to unpublished artifact catalogs, excavation notes, photographs, and other materials related to the Uluburun site which were invaluable for the discussions of the physical characteristics of Bronze Age copper ingots and the

technology involved in ancient smelting, refining, and casting of metal ingots. I am indebted to the many students and colleagues of Dr. Pulak who have contributed to this material since the site's discovery in 1982, though I personally know only the most recent contributors from the Nautical Archaeology Program at Texas A&M University. Appendix B, a description of terms used in the physical description of oxhide and bun ingots from the Uluburun ship, is based on work by myself and Tom Larson, under the guidance of Cemal Pulak, during the summer of 2003. Tom also worked extensively on the organization and artifact descriptions of the copper oxhide and bun ingot catalogs. Sam Lin was a major contributor to the work on the copper bun ingots. Mark Polzer assembled the oxhide and bun ingot catalogs in their current form, including the scanning of hundreds of artifact photos, while Wendy van Duivenvoorde recently completed the latest revisions and reorganization of the tin ingot catalog. I would also like to thank the staff at the Bodrum Museum of Underwater Archaeology in Bodrum, Turkey, for their assistance during my periods of work on the Uluburun ingots at the museum in July and August of 2003 and 2004, and in October of 2005. Conservation work performed at the Bodrum Museum, under the Institute of Nautical Archaeology (INA), since the excavation of the Uluburun wreck has made a detailed study of the metal ingots from the wreck possible.

Finally, I would like to thank my parents, who since childhood have always encouraged my interest in archaeology.

## TABLE OF CONTENTS

	Page
ABSTRACT .....	iii
ACKNOWLEDGMENTS.....	v
TABLE OF CONTENTS .....	vii
LIST OF FIGURES.....	x
LIST OF TABLES .....	xiii
CHAPTER	
I INTRODUCTION. OXHIDE INGOTS, COPPER PRODUCTION, AND THE MEDITERRANEAN COPPER TRADE IN THE BRONZE AGE.....	1
II TEXTUAL EVIDENCE FOR COPPER PRODUCTION AND TRADE IN THE EASTERN MEDITERRANEAN BRONZE AGE.....	10
Copper Ingots in Egyptian Texts and Tomb Paintings .....	33
Textual Evidence for Organized Metalworking in Mycenaean and Syro-Palestinian States.....	40
1) Pylos and Knossos .....	40
2) Alalakh .....	45
3) Ugarit .....	47
Textual Evidence for Trade in Metals in Anatolia and the Near East .....	58
Mesopotamian Texts and Iconographic Evidence .....	62
III THE ARCHAEOLOGICAL CONTEXTS AND PHYSICAL CHARACTERISTICS OF BRONZE AGE METAL INGOTS...	71
Oxhide Ingots .....	71
Incised and Impressed Marks on Bronze Age Ingots.....	96
IV SMELTING TECHNOLOGY AND THE PROCESSING AND SMELTING OF COPPER ORES IN THE BRONZE AGE.....	110
Fuel for Metallurgical Processes .....	123
Bronze Age Evidence for Smelting Technology.....	131

CHAPTER	Page
V	COPPER AND TIN SOURCES IN THE MEDITERRANEAN REGION DURING THE BRONZE AGE ..... 144
VI	SOURCING COPPER: LEAD ISOTOPE AND TRACE ELEMENT ANALYSES OF COPPER INGOTS AND OTHER BRONZE AGE COPPER AND BRONZE ARTIFACTS ..... 167
	Results of Lead Isotope and Trace Element Analyses of Bronze Age Mediterranean Artifacts ..... 178
VII	BRONZE AGE METALLURGICAL PRODUCTION AND THE MANUFACTURE OF COPPER INGOTS ..... 202
	Ingot Composition and Evidence for Production Processes .. 203
	Evidence for Bronze-Age Metallurgical Installations and the Casting of Copper Ingots..... 208
VIII	ARCHAEOLOGICAL EVIDENCE FOR COPPER PRODUCTION IN LATE BRONZE AGE CYPRUS ..... 239
	Evidence of Large-Scale Metallurgical Activity Pre-dating the Late Bronze Age/Late Cypriot Period ..... 242
	Aegean and Near Eastern Copper Sources of the Early and Middle Bronze Age..... 250
	Late Cypriot Sites and the Copper Trade ..... 262
	Metallurgy in Cypriot Coastal Settlements ..... 271
	1) Enkomi ..... 271
	2) Kition ..... 282
	3) Hala Sultan Tekke..... 290
	Metallurgy at Inland Settlements ..... 292
	1) Atheniou..... 293
	2) Kalavassos <i>Ayios Dhimitrios</i> and Maroni <i>Vournes</i> ..... 299
	Late Cypriot Metallurgical Activity in Mining Areas..... 305
	1) Politiko <i>Phorades</i> ..... 306
	2) Apliki <i>Karamallos</i> ..... 311
IX	CONCLUSION. THE ORGANIZATION AND EVOLUTION OF THE COPPER TRADE IN THE BRONZE-AGE MEDITERRANEAN ..... 317
	WORKS CITED ..... 341



	Page
APPENDIX 1 BRONZE AGE CHRONOLOGIES.....	415
APPENDIX 2 LOCATIONS AND CONTEXTS OF COPPER OXHIDE INGOT AND TIN INGOT FINDS .....	417
APPENDIX 3 GLOSSARY OF METALLURGICAL TERMS .....	431
VITA.....	435

## LIST OF FIGURES

FIGURE		Page
1	Oxhide ingot from the Uluburun shipwreck .....	3
2	Oxhide ingot bearer from 'Keftiu.' .....	34
3	The Egyptian physician Nebamun receiving a high-status Syrian.....	37
4	Distribution of oxhide ingot finds .....	73
5	Bass' modification of Buchholz's (1959) oxhide ingot typology.....	75
6	'Type 1' ingots from the Minoan palaces of Hagia Triadha (a, b) and Tylissos (c).....	76
7	Two of the Type 1 ingots from the Uluburun ship.....	77
8	Tribute bearers, including two men carrying possible oxhide ingots (?), from a relief from the throne room of Shalmeneser III at Nimrud .....	78
9	Copper ingot types from the Uluburun shipwreck.....	79
10	Weighing ring ingots, a scene from the Tomb of Rekhmire, mid-15th century BC .....	81
11	Tin ingot types from the Uluburun ship; oxhide, wedge-shaped and plano-convex .....	94
12	Other tin ingot types from the Uluburun wreck: KW 2911, a rectangular ingot, and KW 3935, an 'anchor-shaped' ingot .....	95
13	Oxhide ingot with T-shaped impressed mark from Enkomi .....	97
14	Chiseled marks made on the sides of the copper oxhide ingots from Uluburun .....	101
15	Score-marks found on the Uluburun copper oxhide ingots.....	105
16	Limestone oxhide ingot mold from Ras Ibn Hani, Syria .....	106
17	Reconstruction of a Late Bronze Age slag-tapping furnace from Kition, based on archaeological remains.....	132

FIGURE	Page
18	Slag cake from the smelting site of Politiko <i>Phorades</i> in Cyprus, showing the impression left by a thorough separation of slag and (in this case) copper matte ..... 134
19	Ceramic pot bellows from the Old Babylonian site of Tel edh-Dhiba'i, near modern Baghdad..... 139
20	Reconstruction of crucible smelting using a 'D'-shaped tuyere, based on archaeological remains from the Middle Cypriot site of Ambelikou- <i>Aletri</i> ..... 140
21	Crucible furnace with unusual tuyeres from Qantir in the Nile Delta, 13th century B.C..... 141
22	Melting copper and casting bronze doors using pot bellows, crucible or buried furnaces, and crucibles..... 142
23	Map of major metallurgical sites and ore deposits in the Bronze Age Cyclades ..... 180
24	Late Cypriot furnace lining or crucible from Enkomi..... 206
25	Rectangular ingot fragment KW 3329 (left) and KW 388 (right), from the Uluburun shipwreck ..... 212
26	Rough surface of KW 3329..... 212
27	Tylecote's reconstruction of the use of the Enkomi furnace lining..... 217
28	Plan of cruciform furnace from Qantir, 13th century BC ..... 222
29	Map of Cyprus showing major Bronze Age sites mentioned in the text..... 240
30	The 'Ingot God' from Enkomi and the 'Bomford Goddess' ..... 273
31	Oxhide ingot bearer in the Royal Ontario Museum, 12th century BC ..... 275
32	Closeup of the mold surface and transverse side of one of the 'pillow' ingots from the Uluburun ship..... 433

FIGURE	Page
33 Closeup of rough surface of two-handled oxhide ingot KW 3706 from the Uluburun ship.....	434

## LIST OF TABLES

TABLE		Page
1	Descriptive Terms for Copper in Assyrian Texts from Kaniš/Kültepe (After Derckson 1996, 33-43).....	31
2	Estimates of Ore and Fuel Required to Smelt Copper Sulfide Ore Using Premodern Techniques.....	125
3	Dimensions and Construction Materials of Excavated Bronze Age Metallurgical Furnaces.....	136

CHAPTER I

INTRODUCTION: OXHIDE INGOTS, COPPER PRODUCTION,  
AND THE MEDITERRANEAN COPPER TRADE IN THE  
BRONZE AGE

The connections between metallurgical technology, trade, and social organization have long been recognized in the development of Bronze Age societies of the Mediterranean and Near East.<sup>1</sup> Metal ores, particularly the ores of copper and tin that became so important in the Bronze Age, take an enormous amount of labor and technological expertise to extract from the natural environment and process into useful finished products. Metal ores also occur in geographically localized areas, which would have limited access of prehistoric communities to metals and encouraged long-distance trade between them. By the second millennium B.C., Mediterranean societies had developed complex trade networks to transport and exchange metals and other bulk goods over long distances.<sup>2</sup> Copper, particularly as the main component of bronze, became one the most important materials for tools, weapons, and status-enhancing luxury goods during the Bronze Age.<sup>3</sup> Much of the metals trade in the Bronze Age Mediterranean and Near East—such as the trade between Mesopotamia and Dilmun (probably Bahrain in the Persian Gulf), and between Egypt, the Levant,

---

This thesis follows the style and format of the *American Journal of Archaeology*.

<sup>1</sup> Knapp 1993, 89, 91, 94-6; Muhly 1985a, 123; Manning 1993, 44, 46-7.

<sup>2</sup> Sherratt and Sherratt 1991, 361-2.

<sup>3</sup> Sherratt and Sherratt 1991, 361-2.

the Aegean, and later, the central Mediterranean—was conducted by sea, since such bulk cargoes were far easier to move by sea than overland.<sup>4</sup>

Metal ingots from Bronze Age archaeological contexts provide some of the most important evidence for the early trade in metals in the Mediterranean. The distinctive copper ‘oxhide’ ingots in use in the eastern and central Mediterranean from c. 1600 B.C. to the mid-11th century B.C. are closely associated with maritime trade. Many finds of copper oxhide ingots from the Late Bronze Age Mediterranean cluster around coastal areas and coastal sites likely involved in long-distance maritime trade.<sup>5</sup> Direct evidence for the transport of copper ingots by sea in the Late Bronze Age has been discovered on the shipwrecks at Uluburun (c. 1300 B.C.) (Figure 1) and Cape Gelidonya (c. 1200 B.C.); in addition, Bronze Age copper and tin ingots have been recovered from underwater contexts off the coasts of Greece, Turkey, Israel, and other areas of the Mediterranean, and large numbers of complete and fragmentary oxhide ingots have been found on inland sites in the Mediterranean, particularly those on the islands of Crete, Cyprus, and Sardinia.<sup>6</sup>

---

<sup>4</sup> Weeks 2003, 1, 14-7; Van Andel and Runnels 1988, 243-4; Gale 1991, 200.

<sup>5</sup> Gale 1991, 200.

<sup>6</sup> Pulak 1997, 234-5; Buchholz 1959, 28-39; Bass 1967, 57, 61-2; LoSchiavo 1982, 271-2; Galili et al. 1986.



**Figure 1: Oxhide ingot from the Uluburun shipwreck (Photo by the author).**

By the end of the Late Bronze Age (c. 1200 B.C.), several Mediterranean cultures had become dependent on or had been influenced by maritime trade and interregional contacts established at least in part for access to copper and tin. Other metals played a role in long-distance trade as well; gold, lead, silver, and tin were also traded over long distances in the Bronze Age, though not in the same quantities as copper.

The exact nature of this trade has been debated for years. The metals trade would have differed considerably in volume and organization in different regions, depending on locally available resources, geography, established trade routes, local metallurgical technology, and various social and political factors. Some of the best evidence for aspects of the early trade in copper and tin come from Near Eastern texts of the late third and second millennium B.C. While some textual evidence for the activities of independent merchants in the Bronze Age is known from Mesopotamia, Anatolia, and the Mediterranean, their role in the development of long-distance trade in metals probably varied over time. By the Late Bronze Age, merchants in most cases would have likely operated within largely centralized palace economies dominated by rulers



or small numbers of elites.<sup>7</sup> Textual evidence from the Aegean palaces at Knossos and Pylos, the Syro-Canaanite cities of Ugarit and Alalakh, and the Amarna texts from Egypt provide evidence for a high degree of centralization in the production of copper and bronze goods and, in some instances, in the importation of copper as well.<sup>8</sup> None of these states (perhaps with the partial exception of Egypt) are known to have had access to significant local copper and tin sources; therefore, they must have imported the large amounts of copper and tin used in their local bronze industries.<sup>9</sup>

Cyprus is generally considered to be the dominant exporter of copper in the eastern Mediterranean during the Late Bronze Age. While the pattern of copper exploitation and trade was complex, and is poorly understood for the earlier part of the Bronze Age, Cyprus seems to have supplied at least much of the copper in use in most of the societies of the eastern and central Mediterranean by the second half of the second millennium B.C., with Cypriots playing an important and perhaps dominant role in this trade in the 14th to 12th centuries B.C.<sup>10</sup> Though largely exhausted today, the foothills of the Troodos Mountains in western and central Cyprus contained the largest accessible copper deposits in the eastern Mediterranean; in later antiquity, the island was famous as a source of copper ore and timber, the two main ingredients necessary for copper smelting.<sup>11</sup> However, smaller or less systematically exploited sources in the Aegean, Anatolia, Egypt and the Sinai, the Balkans, and modern-day Jordan and Israel

<sup>7</sup> Pulak 1997, 251; Sasson 1966, 134-5; Zaccagnini 1987, 57; Muhly et al. 1988, 288-9; Artzy 1994, 138; Sherratt 2000, 84-5, 87-8.

<sup>8</sup> Ventriss and Chadwick 1973, 251-2, 354-5, 358; see also Amarna tablets EA 33-7 and EA 40 (in Moran 1992, 104-11, 113); Linder 1981, 32-3, 37; Heltzer 1982, 101-2, 187; Cunliffe 2001, 207, 215.

<sup>9</sup> Muhly 1973a, 187-92, 209-10; Branigan 1968, 57; 1974, 57-65; Gale and Stos-Gale 1991, 255.

<sup>10</sup> Muhly 1973a, 183-234; 1985c, 81-2; 1999; Muhly et al. 1988, 285; Gale and Stos-Gale 1985, 93-6; 1989; 1991, 255; 1999; Stos-Gale and MacDonald 1991; McGeehan Liritzis 1996, 118-9; Yener 2000, 17-70.

<sup>11</sup> Wertime 1982, 352; Weisgerber 1982, 28; Constantinou 1992; Wells 2001, 132.

played important roles in early metallurgy, particularly before the second millennium B.C.<sup>12</sup>

Evidence of the importance of copper metallurgy in Late Cypriot society comes from many excavated sites (see Chapter VIII and Appendix 2). By the Late Cypriot period (c. 1400-1100 B.C.), the sites of Enkomi, Kition, Hala Sultan Tekke, and several other settlements became wealthy regional centers, particularly in the latter half of this period (Late Cypriot IIC, c. 1320-1200 B.C.).<sup>13</sup> These cities seemed to have played a major role in copper production and export; several have also provided archaeological evidence of copper metallurgy within some settlements.<sup>14</sup> Unlike the palaces of Mycenaean Greece and Crete or Near Eastern cities, these Late Cypriot centers have not produced documents involved with trade or metalworking; the few Bronze Age inscriptions discovered on the island are written in an undeciphered script called ‘Cypro-Minoan’ by epigraphers.<sup>15</sup> The function of these texts is unknown, although some signs possibly from a Cypro-Minoan alphabet have been identified on trade items such as Cypriot and Mycenaean pottery, oxhide and plano-convex or bun ingots, and miniature oxhide ingots.<sup>16</sup> The connection between ‘Cypro-Minoan’ symbols or scripts influenced by Cypro-Minoan and trade goods, particularly pottery and metal ingots, is now well-established.<sup>17</sup>

<sup>12</sup> Muhly 1973a, 190-2, 199-200, 210-1, 215-20; Waldbaum 1978, 59-66; Levy et al. 1980; 2002; Rothenberg 1988; 1990; Jovanović 1988, 69-71, 76-8; Yener 2000; Gale et al. 2003, 168-70.

<sup>13</sup> Knapp 1986, 2, 6; Hellbing 1979, 91; Karageorghis 1982, 62; 2002, 11, 57-8; South 1989.

<sup>14</sup> Knapp 1986, 10-3, 20-5; South 1980, 42; Lagarce and Lagarce 1996, 2; Karageorghis and Kassianidou 1999, 179; Westover 1999, 86-7.

<sup>15</sup> Karageorghis 2002, 17-9; Smith 2002, 1, 20-30.

<sup>16</sup> Hirschfield 1991, 2-3; 2002; Masson 1971; Pulak 2000a, 146; Smith 2002;.

<sup>17</sup> Hirschfield 1991; 2001; 2002; Bass 1967, 72-3; Pulak 1998, 194-6; Kassianidou 2003.

For many years, very little evidence of Bronze Age smelting activities on Cyprus was known. Massive slag heaps on the island indicate large-scale copper exploitation in ancient times. Although the volume of these slag heaps has been estimated at four million tons, virtually all of the slag deposits in the mining areas appear to date to well after the Bronze Age.<sup>18</sup> While more evidence for Middle and Late Cypriot copper mining and metallurgical production is available today, unfortunately this evidence is generally fragmentary and difficult to interpret.

Other sources of evidence have been more productive, however. Lead isotope analysis of Bronze Age copper ingots have provided near-conclusive evidence that Cypriot copper was exported on a significant scale, at least towards the end of the Bronze Age.<sup>19</sup> Chemical and metallographic analyses have shown that oxhide ingots were made of highly pure copper and were of a uniform quality, which suggests that a highly standardized production process, perhaps initiated and controlled by a central authority, was used to produce them.<sup>20</sup>

Bronze Age shipwreck discoveries, particularly the Uluburun and Cape Gelidonya shipwrecks discovered off the southern coast of Turkey, have provided important evidence for the nature and organization of the copper trade in the eastern Mediterranean between c. 1300-1200 B.C. The main cargo of the Uluburun ship was over ten tons of copper, as well as approximately one ton of tin ingots.<sup>21</sup> The number

---

<sup>18</sup> Weisgerber 1982, 25; Catling 1964, 20; Knapp 1999, 99-101; 2002.

<sup>19</sup> Stos-Gale and Gale 1994, 99-104, 116-121; Gale 1999, 110.

<sup>20</sup> Hauptmann et al. 2002; Balmuth and Tylecote 1976; Tylecote 1976, 170-1; Muhly et al. 1977; Muhly 1979, 91, 94-5; Muhly et al. 1980, 90-4; Gale and Stos-Gale 1984, 100, 103; Gale and Stos-Gale 1986, 85, 89; Muhly and Maddin 1988, 471-2; Muhly et al. 1988, 283-8; LoSchiavo et al. 1990, 183; Primas and Pernicka 1998; Mangou and Ioannou 2000, 210, 213-4; Lichardus et al. 2002, 166, 171-3.

<sup>21</sup> Pulak 1997, 235, 239.

of complete oxhide ingots on this wreck (354) exceeds the number of those previously known from both land and underwater sites.<sup>22</sup> Besides metals, the ship carried as cargo a large number of glass ingots, about one ton of terebinth resin in ‘Canaanite’ jars, Cypriot pottery in several pithoi, and a wide array of luxury goods and other items, some of which were the personal possessions of the crew and passengers.<sup>23</sup> The unusually rich cargo of the ship indicates that it was probably part of a royal consignment from one ruler, possibly Syro-Palestinian, to another, perhaps located in the Aegean.<sup>24</sup>

While dating to only about a century after the Uluburun ship, the Cape Gelidonya ship’s metal cargo is significantly different. The vessel carried thirty-four complete copper oxhide ingots as well as other ingot types, copper oxhide ingot fragments, a large cargo of scrap metal, and a small amount of tin, probably in ingot form.<sup>25</sup> However, the ship also carried a large amount of bronze scrap in the form of old and worn out tools and other objects and casting waste, and a probable set of smith’s tools, besides ship’s equipment and personal possessions of the crew.<sup>26</sup> In all, the ship carried about one ton of metal cargo.<sup>27</sup> The Cape Gelidonya ship seems to represent a small trading vessel crewed by a group of seafarers and merchants, perhaps with a bronze smith on board, who were of a lower status than those on the Uluburun ship.<sup>28</sup>

---

<sup>22</sup> Gale 1991, 200-1; Buchholz 1959; Bass 1967, 57, 61-2; Dimitrov 1979, 70, 73; Wachsmann and Raveh 1984, 169; Pulak 1997, 235, 239; 2001, 18-9; Demakopolou et al. 1998, 37.

<sup>23</sup> Pulak 2001, 125-50.

<sup>24</sup> Pulak 1997, 251.

<sup>25</sup> Bass 1967, 52-83.

<sup>26</sup> Bass 1967, 84-121.

<sup>27</sup> Bass 1967, 163.

<sup>28</sup> Bass 1967, 163.

These cargoes raise a number of questions. How typical are Uluburun and Cape Gelidonya wreck's cargoes for copper carriers of the period? Are the smaller assemblages of Bronze Age copper and tin ingots recovered from the sea more typical of the maritime trade in metals in the period, or were extremely large cargoes, perhaps transported on a more occasional basis, the norm? This problem also applies to land-based trade in copper and other metals as well. It is likely that the production and circulation of metals occurred in several different ways in the third and second millennia B.C. However, the dominant trade mechanisms would have varied considerably from one region and time period to another, based on factors such as metal production and transport technology, geological and geographical factors, social organization in the societies involved, the uses to which metals were employed, etc. As one of the first important items of long-distance bulk trade in the Mediterranean, copper played a major role in the development of Mediterranean civilization. Although incomplete in many respects, a large body of data is available on the production and trade of copper and other metals in the Bronze Age. By investigating the production, transport, and destinations of copper and other metal cargoes, we can better understand how trade routes and societies developed in the Mediterranean Bronze Age.

Several categories of evidence exist for the production and trade of copper and other metals in the Bronze Age Mediterranean. Textual evidence for metalworking and trade in metals in different periods of the Bronze Age has been discovered in Mesopotamia, Syria-Palestine, Egypt, Anatolia, and the Aegean; these texts provide varying amounts of information on metallurgical and trading activities in specific cultures during specific periods, and are in some cases useful for broader generalizations as well.

Iconographic evidence for raw materials and finished metal products exist throughout the Mediterranean; several cultures, including the Egyptians, Cypriots, and Mycenaeans, produced pictorial representations of oxhide ingots. Representations of oxhide ingots demonstrate a cultural group's familiarity with copper ingots in this form and therefore their access to interregional trade routes connected with the source or sources of copper used to make oxhide ingots. In the case of Egyptian tomb paintings and reliefs that depict oxhide ingots, iconographic evidence also provides some information on the different foreign groups involved in trade with Egypt, as well as the nature of the goods exchanged but unfortunately very little concrete information on the logistics of copper trade itself.<sup>29</sup> Archaeological evidence for mining, smelting, and other metallurgical activities comprises the largest body of information, although, perhaps, also the most difficult to interpret. Such information occurs throughout the eastern and central Mediterranean, and has increased dramatically in the past twenty-five years. Finally, lead isotope and trace element analyses of Bronze Age metal artifacts can be applied to discovering the ore source or sources exploited as well as the technological processes used to produce a particular object; these analyses have been vital in establishing the sources of ingots and other metal objects and in providing information on smelting and other metallurgical activities.

---

<sup>29</sup> For representations of oxhide ingots in Egyptian tomb paintings, cylinder seals, and other media, see Buchanan 1966, n. 956, 974-8; Bass 1967, 62-9; Knapp 1986, 38-40, Fig. 2, Pl. 8-11; Rystedt 1987, 49-56; Webb 1999, 273-81.

## CHAPTER II

### TEXTUAL EVIDENCE FOR COPPER PRODUCTION AND TRADE IN THE EASTERN MEDITERRANEAN BRONZE AGE

The most direct textual evidence for copper trade in the Late Bronze Age Mediterranean comes from Tell el Amarna or Akhenaton, the capital city of the pharaoh Akhenaton (Amenophis IV), who ruled in Egypt during the late 14th century B.C.<sup>30</sup> Over 382 clay tablets were excavated from a royal archive where records of diplomatic correspondence with foreign powers and vassal states were stored.<sup>31</sup> Nearly all of these tablets are letters addressed to the pharaoh, often with inventories of gifts attached.<sup>32</sup> In these letters, familial terms are used: the pharaoh is ‘father’ to rulers and officials of lesser rank, such as vassals in the Syro-Palestinian region, while the rulers of larger empires such as the Hittites and Assyrians call him ‘brother’.<sup>33</sup> Although some of these individuals could have been related by blood or marriage (marriage negotiations are an important part of the Amarna correspondence), these terms seem to have been primarily social conventions used to symbolize the correspondents’ close relationship and possibly also their royal status as well.<sup>34</sup> Typically letters from rulers ‘equal’ to the pharaoh begin with a long, formulaic greeting and then refer to gifts given to the pharaoh, followed by requests for various items and commodities. Usually

---

<sup>30</sup> Moran 1992, xiii.

<sup>31</sup> Moran 1992, xv; Freed et al. 1999, 158. The Levantine city of Byblos apparently had a similar archive, mentioned in the Twenty-first Dynasty (11th century B.C.) Tale of Wenamon; however, these records were written on papyrus or some other perishable material (see Pritchard 1950, 25, 27).

<sup>32</sup> Moran 1992, xv.

<sup>33</sup> Moran 1992, xxiv-v; Cline 1994a, 144.

these are luxury goods such as jewelry, textiles, or rare and expensive raw materials.<sup>35</sup>

In many of the letters the details of marriage contracts are also arranged; these marriages typically involved large dowries (which are listed within the letter) and could result in economically and politically profitable alliances.<sup>36</sup>

While the materials changing hands in these exchanges are referred to as ‘gifts’ by both parties, the authors of the Amarna tablets are usually very clear about their intention to profit from these relationships.<sup>37</sup> The expectation of valuable counter-gifts is often explicitly stated in these exchanges; requests for specific ‘gifts’ are the norm, and complaints about the quality or amount of these ‘gifts’ or of their slow delivery are common.<sup>38</sup> Judging from the inventories in the Amarna letters, these exchanges took place on a significant scale, which would have required the dispatch of diplomatic expeditions to foreign capitals.<sup>39</sup> The depictions of ‘Asiatics’, ‘men of Keftiu’, and other foreigners in the tombs of high officials at Thebes may represent the reception of such diplomatic expeditions; presence of many foreigners at these receptions would have been a great honor for an Egyptian official and were, therefore, duly recorded in his tomb.<sup>40</sup>

Similar exchanges are recorded in Homer and have been observed in ethnographic accounts of various primitive societies, such as the Trobriand Islanders in the

---

<sup>34</sup> Moran 1992, xxiv; Cline 1994a, 144.

<sup>35</sup> Moran 1992, xxv, 19, 24-34, 51-7.

<sup>36</sup> Moran 1992, xxiv-v, 6-7, 24-6, 101-2.

<sup>37</sup> Zaccagnini 1987, 62-3.

<sup>38</sup> Cline 1994a, 144. See also Moran 1992, xxiv-v, 7, 9, 19, 39, and 48 for some examples. Liverani (2000, 21-2, 25) suggests that this was a deliberate tactic used by rulers to delay sending valuable gifts and maximize personal gain.

<sup>39</sup> Cline 1994a, 143-4.

<sup>40</sup> Panagiotopoulos 2001, 265, 269-70.



southwest Pacific.<sup>41</sup> M. Finley notes that in the *Iliad* and *Odyssey* gift exchange among elites is essentially pragmatic; it is used to establish mutually profitable alliances, and participation can bring great prestige (or shame) to both giver and receiver depending on the generosity of the gifts given or received.<sup>42</sup> Finley writes that in early Iron Age Greece, “One measure of a man’s worth was how much he could give away in treasure. Heroes boasted of the gifts they had received and of those they had given as signs of their prowess. That is why gift-objects had genealogies.”<sup>43</sup> Finley’s statements are also applicable to the rulers and elites of the Amarna period in the Near East. Participation in international diplomacy required access to large amounts of rare, valuable, or unusual gifts. One letter from the Hittite king Hattusili III to an unknown king (possibly the king of Arzawa) mentions the delivery of an object with a prestigious ‘genealogy’, a “rhyton of pure gold from the gift of the king of Egypt.”<sup>44</sup> Such a gift shows that trading relationships between rulers sometimes included benefits more intangible than economically valuable commodities. According to M. Liverani, trade in the Amarna period operated on several levels: (1) the exchange of symbolically valuable gifts between rulers (rare materials such as ivory, ebony, lapis lazuli, worked metal objects, etc.); (2) the more usual trade of bulk raw materials between rulers (such as the payment of timber and copper by the king of Alashia to the pharaoh); (3) trade between rulers or elites and their social subordinates, in which payment in shekels of silver (the international ‘currency’) is specified; and (4) trade between lower status individuals, which was purely or mainly commercial in character.<sup>45</sup>

<sup>41</sup> Malinowski 1950, 95-99.

<sup>42</sup> Finley 2002, 57, 60-2, 123-5; Moran 1992, xxiv-xxv.

<sup>43</sup> Finley 2002, 123.

<sup>44</sup> Zaccagnini 1987, 58.

<sup>45</sup> Liverani 1979.

The first type of trade is perhaps the most unusual in the modern world. While the motivation for profit is often explicitly acknowledged by the individuals involved, in some cases they are involved in transactions that make little economic sense, such as when participants in the Amarna diplomatic trade exchange identical products. For examples, in one letter (EA 40), a minister of Alashia sends an ivory tusk to Egypt, mentions that he had sent two other ivory tusks in earlier exchanges, and asks for a gift of ivory.<sup>46</sup> Liverani notes that the cost of transporting the tusk to Egypt by sea with a messenger is probably far more than the profit to be gained from the exchange; in addition, ivory was almost certainly easier to obtain in Egypt, which had access to the African interior, than in Cyprus.<sup>47</sup> As a long-term ‘investment’, however, this move is profitable. According to Liverani, the primary motive in this case is to maintain the relationship between the minister and his trading partner, in part for the prestige it brings but, more importantly, because it will be profitable later: “The amicable relationships will eventually blossom from a commercial point of view as well... and already in this letter the *rābiṣu* of Cyprus asks for two favors from his Egyptian colleague—to quickly return the ship and the merchant, and to exempt him from customs dues.”<sup>48</sup> Another possible reason for the exchange is that by sending ivory, a valuable commodity, and asking for this rare commodity in return, which was more common in Egypt, may have been an attempt to receive a better gift:

It is prestigious to be able to send a particularly rare and precious commodity, and a sort of provocation to obtain the same commodity in exchange: if the *rābiṣu* of Alashia has foregone, in favor of his ‘colleague’, his ‘brother’, the possibility of detaining the ivory which for him is so precious, his colleague will not hold back from sending in exchange still more ivory (as it is explicitly

<sup>46</sup> Liverani 1979, 94; Wachsmann 1987, 118.

<sup>47</sup> Liverani 1979, 94-5.

<sup>48</sup> Liverani 1979, 95.

requested) and even in a larger measure, corresponding to the lesser scarcity of the product in Egypt.<sup>49</sup>

Again, the ‘genealogy’ of the material could also play a role; perhaps an object made of ivory sent as a personal ‘gift’ from the king of Egypt confers more status on the owner than an object made of ivory imported by a lower-status individual.<sup>50</sup>

Like ivory sent from Alashia to Egypt, gold and ebony, materials that were obtained from Egypt, were at times sent from the kings of Babylon and Mitanni to the pharaoh in Egypt, with the gift in the latter case included in a letter requesting gold.<sup>51</sup> Two Mesopotamian rulers request lapis lazuli from Egypt, a material which was mined in Afghanistan and would have been much more accessible to Mesopotamia than to Egypt.<sup>52</sup> The pharaoh also sends goods that were not easily obtainable in Egypt, such as copper, silver, and lapis lazuli.<sup>53</sup> Liverani speculates that a portion of the gifts sent in this way “were not ‘commercial items under the form of gifts’, but really and simply gifts,” made of materials that were not socially acceptable to ‘sell’ as were those commodities of more mundane materials. Similarly, the shell bracelets or kula rings exchanged by chieftains in the Trobriand Islands’ kula ring were received only to be given away again.<sup>54</sup>

<sup>49</sup> Liverani 1979, 95-6; Wachsmann 1987, 118.

<sup>50</sup> While noting the importance of the profit motive in almost all gift exchanges in the Amarna texts, Bachhuber (2006) cites this ivory exchange as a rare example of “pure gift-giving behavior”: “The economic irrationality of the transaction eliminates the exchange value of the ivory while simultaneously demonstrating an indissoluble bond between the ivory and the Alashiyan governor” (2006, 350). Judging from the pragmatic and often acrimonious nature of other correspondence from the Amarna archives and other diplomatic correspondence of the period (see, for example, Bachhuber 2006, 355-6), such “pure” gift-giving behavior seems highly unlikely.

<sup>51</sup> Liverani 1979, 96-7.

<sup>52</sup> Liverani 1979, 96; See Hermann 1968 for sources of lapis lazuli in central Asia.

<sup>53</sup> Liverani 1979, 96.

<sup>54</sup> Liverani 1979, 97-8.

While both economic and symbolic aspects of the Amarna trade were important, the exact nature of these exchanges has been debated. Some scholars have seen the symbolic aspect of the exchange as being of primary importance, while others have emphasized the profitable nature of these trade networks and view them as primarily commercial enterprises.<sup>55</sup> The Amarna tablets provide evidence for both aspects of elite exchanges. Some letters emphasize the relationship established and maintained by the participants rather than the values of the goods exchanged, as in claims by the Babylonian king in certain letters that exchanges with Egypt were not economically necessary for either country but were merely gestures of goodwill.<sup>56</sup> On the other hand, the standard etiquette of familial terms is even questioned in one contemporary letter from Hattusili III of Hatti to the Assyrian ruler Shalmeneser I: "...[W]hy should I write to you about brotherhood? You and I, were we born of the same mother?"<sup>57</sup> In other letters, the symbolic aspects of these gifts are frequently downplayed and the value of the gifts is explicitly emphasized. For example, in EA 16 of the Amarna tablets, Assur-uballit, the king of Assyria, makes this point explicit in a complaint about his messengers being delayed in the Egyptian court: "Why should messengers be made to stay constantly out in the sun... [?] If staying out in the sun means profit for the king, then let him stay out and die in the sun, [but] for the king himself there must be a profit."<sup>58</sup> The meticulous inventories of gifts in the letters show their economic importance, as do comments emphasizing the material profits derived from a particular relationship. For example, the king of Alashia comments to the pharaoh on the profitability of exchanging gifts with him: "Do not compare me with the king of

<sup>55</sup> Snodgrass 1991, 15-8; Sherratt and Sherratt 1991, 352-4, 358-9; Panagiotopoulos 2001, 275-8.

<sup>56</sup> Zaccagnini 1987, 62-3; Moran 1992, 12-6.

<sup>57</sup> Zaccagnini 1987, 62.

<sup>58</sup> Moran 1992, 39.

Hatti or the king of Babylon: as for me, whatever gift my brother has sent [to me], I have returned twice as much.”<sup>59</sup>

The Amarna letters show that the rhetoric and structure of the gift exchange network could easily accommodate a variety of economic, diplomatic, and symbolic needs of the participants, depending on specific circumstances and the customs of each society involved.<sup>60</sup> Rulers across the eastern Mediterranean and Near East would have shared a need to procure treasure or luxury goods to award gifts to their own followers, ensure peace with foreign powers, and prove one’s own status by physical proof of relationships with distant but powerful rulers.<sup>61</sup> However, elite gift exchanges probably did not account for all long-distance trade during the Late Bronze Age. The inventories in the Amarna texts occasionally concern huge amounts of luxury items and finished objects, but more often the number of gifts delivered are much smaller; in addition, besides one series of letters referring to the exchange of copper and timber, the letters rarely refer to raw materials that are not luxury goods (precious metals, precious stones, ivory, etc.).<sup>62</sup> A differentiation between royal and elite gift exchange and royal trade has also been proposed, although such a division is likely difficult to recognize in many cases.<sup>63</sup> Gift exchanges seem to have been occasional events, perhaps occurring once a year or even more occasionally; royal messengers could be detained in a foreign court for up to several years, a source of complaint in several of the Amarna letters.<sup>64</sup>

<sup>59</sup> Zaccagnini 1987, 63; see also Moran 1992, 108, for a different translation.

<sup>60</sup> Liverani 2000, 24-5; Muhly 1982, 252; Sherratt and Sherratt 1991, 351-4, 358; Moran 1992, xxiv-v.

<sup>61</sup> Liverani 2000, 21.

<sup>62</sup> Panagiotopoulos 2001, 276; Moran 1992.

<sup>63</sup> Panagiotopoulos 2001, 275-8.

<sup>64</sup> See EA 3, EA 28, EA 33, EA 35, and EA 38 for some examples (Moran 1992, 13-5, 90-1, 104, 108, 111). Hellbing (1979, 38) sees the detaining of messengers in foreign courts as part of the “diplomatic manners of that time”, probably as a demonstration of power and independence. In EA 35, the king of

Such infrequent exchanges are unlikely to be able to account for all of the foreign imports found in different areas of the eastern and central Mediterranean. Prestige items traded between the rulers and the highest elites probably accounted for only a fraction of the interregional trade in the Late Bronze Age. Other textual sources as well as the distribution of utilitarian containers such as ‘Canaanite’ jars from the Syro-Palestinian coast show that agricultural products such as grain, wine, resin and olive oil were important trade items in maritime and overland trade.<sup>65</sup> In one instance, the Hittite king requests Ugarit to send 2,000 measures of grain (estimated at 450 tons) to Ura in Cilicia.<sup>66</sup> More mundane economic transactions by lower status individuals accompanying elite gift exchange missions could have been one aspect of gift-exchanges as economic activities; such behavior is known from ethnographic studies such as Malinowski’s account of gift exchanges among the Trobriand Islanders.<sup>67</sup> EA 39, a letter sent to the Egyptian pharaoh from the king of Alashia, seems to indicate similar activity; the king states in his letter that “These men [the bearers of the letter] are my merchants... let them go safely and prom[pt]ly. No one making a claim in your name is to approach my merchants or my ship.”<sup>68</sup> Since the letter mentions no delivery of or requests for specific ‘gifts’, it is possible that the bearers of the letter were merchants officially sanctioned by the king of Alashia to trade in Egypt, either for the king or independently, and who were sometimes required to act as diplomatic envoys

---

Alashia mentions that he has detained the pharaoh’s messenger for three years, an action which Hellbing interprets as that of an independent ruler: “No doubt... this was something that only wholly independent princes could permit themselves to do to the mighty pharaoh of Egypt” (Hellbing 1979, 38; cf. Moran 1992, 108). This practice may have also served an economic function, to make gift-payments to foreign rulers as infrequently as possible (Liverani 2000, 22, 25).

<sup>65</sup> Heltzer 1977, 209-10; Linder 1981, 36; Wachsmann 1998, 313-4.

<sup>66</sup> Wachsmann 1998, 41; Hofijzer and van Soldt 1998, 341.

<sup>67</sup> Malinowski 1950, 99-100; Cline 1994a, 149.

<sup>68</sup> Moran 1992, 112; Wachsmann 1998, 307.

as well.<sup>69</sup> The word for the envoys involved in Near Eastern gift exchanges, ‘messengers’ (*mār šipri*), is sometimes used interchangeably with the Akkadian word for ‘merchants’ (*tamkāru*); similarly, Assyrian merchants in Anatolia during the 19th century B.C. seem to have conducted both official and private trade.<sup>70</sup> It is therefore likely that these individuals may have conducted business transactions on their own or on the behalf of others in addition to performing their duties to the palace.

If in fact the mostly ceremonial exchanges in the Amarna tablets were separated to some extent from commercial trade, either in the hands of royalty or independent private traders, then the scarcity of references to bulk shipments of copper in the Amarna letters becomes more explicable. The amounts of goods sent by the king of Alashia to Egypt are rivaled in size only in a few of the letters, particularly those listing dowries for royal marriages; Panagiotopoulos (2001) points out the discrepancy between the amounts of gifts sent for marriages and the usual amount of gifts sent in a typical gift exchange, as well as the unusual size of some of the Alashian consignments to Egypt.<sup>71</sup> Liverani (1979) states that “international trade in this period occurred on at least two levels, which were kept substantially separate”: the level of ‘prestige’ exchanges between rulers or elites of roughly equal status, and a more directly commercial level of exchange by merchants.<sup>72</sup> The difference may be most clearly indicated in the use of silver as a form of currency; if the values of

---

<sup>69</sup> Moran 1992, 112. Liverani (2000) elaborates: “An economy of journeys is also evident in the occasional habit of entrusting merchants with official state letters, a use attested in Babylonia (Salmu is a “merchant” in EA 11:Rs. 8, but a ‘messenger’ in EA 7:73) and for Cyprus (EA 39-40). The precise status of the personnel entrusted with carrying letters seems variable but generally proportionate to the matter at hand: dynastic marriages are discussed by high-ranking ‘ambassadors’... whereas trivial problems can be entrusted to merchants. Routine letters are delivered by professional couriers. A mismatch between the rank of the messenger and the relevance of the subject matter gives rise to open disputes” (22).

<sup>70</sup> Zaccagnini 1977, 171-4, 180-5.

<sup>71</sup> Panagiotopoulos 2001, 276-8.

<sup>72</sup> Liverani 1979, 99.

commodities are explicitly stated in shekels of silver, then it is a commercial exchange, while if they are not provided, it is more likely a prestige exchange (although the value of the object in silver may be implicitly estimated by the participants in the exchange).<sup>73</sup> Rulers themselves may have rarely participated in the first type of exchange, or at least neglected to record their direct participation. However, two exceptions are present in the Amarna letters. The first in the exchange with the king of Alashia, who requests “silver in large quantities” in exchange for copper and timber. Similarly, a tablet from Ugarit records the purchase by the king of Alashia of olive oil, with payment in silver.<sup>74</sup> Besides being used for payment on bulk goods, payment in silver is also used in cases when a higher-ranking individual, including rulers, do business with lower-status individuals.<sup>75</sup> In this way, Bronze-Age elites could take advantage of both methods of exchange when convenient.

References to raw copper, as opposed to finished copper or bronze objects, occur in the Amarna letters only in a series of letters from the king of Alashia, a locality usually identified as Cyprus.<sup>76</sup> The trading relationship between Egypt and Alashia dates at least to the reign of Amenophis III (c. 1417-1379 B.C.), based on a copy or draft of a letter from an (Egyptian?) official in Ugarit to the pharaoh concerning

---

<sup>73</sup> Liverani 1979, 100.

<sup>74</sup> Liverani 1979, 100-1.

<sup>75</sup> Liverani 1979, 101.

<sup>76</sup> Though Alashia is most commonly identified with Cyprus (e.g., Muhly 1996, 49), Alashia has also been located by some scholars elsewhere, such as on the coast of northern Syria, though the petrographic evidence from the tablets disproves this association; see Hellbing 1979, 65-73; Strange 1980, 147, 182-4; and Goren et al. 2003, 235-42). Petrographic and chemical studies of the Amarna tablets from Alashia and tablets sent to Ugarit from Alashia have now been traced to clay deposits in southern Cyprus (Goren et al. 2003, 242-4), indicating that the capital of Alashia may have been in south-central Cyprus (possibly Kalavassos *Ayios-Dimitrios* or *Alassa Pano Mandilaris*) rather than on the east and southeast coast of the island (at Enkomi, Hala Sultan Tekke, or Kition) (Goren et al. 2003, 235-42, 248-51). For a history of the scholarship on Alashia and a refutation of arguments equating Cyprus with Alashia, see Merrillees 1987.



commercial transactions with the king of Alashia.<sup>77</sup> However, most of the textual evidence for exchanges between the two regions are found in a series of letters from the Amarna archives. In his opening letter (EA 33), the king of Alashia responds to a request from the pharaoh for copper, sending 200 units of copper and 10 units of “fine copper” to Egypt.<sup>78</sup> In subsequent letters, the king of Alashia alludes to additional shipments of 100 units of copper (EA 34), and 500 units of copper (EA 35) to Egypt.<sup>79</sup>

<sup>77</sup> Lipiński 1977, 213-7.

<sup>78</sup> EA 33:9-18. Moran translates these units as ‘talents’, or else ‘bars’ or ‘ingots’, depending on their context (Moran 1992, 104-5). Although some of the Alashia texts specify amounts as being in ‘talents’, there are variations in terms for these units which leave room for alternative interpretations (for example, Zaccagnini interprets the amount of copper in EA 35 as 500 shekels, or about 4 kg, rather than 500 talents, or about 14,500 kg) (Zaccagnini 1986, 414; cf. Muhly et al. 1988, 297). Zaccagnini (1986, 414) notes that very similar variations in terms for units of metal also occur in contemporary Hittite texts. One talent is approximately 29 kg, although many different variations of Near Eastern and Egyptian weight standards were in use in different areas and in different time periods during the Bronze Age (see Petrie 1934, 16-7; cf. Petruso 1992, 60; Lassen 2000; Pulak 2000b, 140). Zaccagnini (1986, 416-7) recognizes at least four different ‘talents’ in use in the Bronze Age Near East and eastern Mediterranean, ranging in weight from 23.5 to 30.3 kg, as well as a ‘Mycenaean talent’ of unknown weight, possibly 29-31.2 kg, and a ‘Western’ talent used by the Syrians and Hittites, weighing 28.2-28.4 kg. Some variation in weight standards may also be due to inaccuracies in weights and different local weight standards; this fact seems to have been accounted for in correspondence between Assyrian merchants in the 19th century B.C. Kanish texts from Anatolia (Petruso 1992, 5-6; cf. Veenhof 1972, 51). The weight standards of major civilizations such as Egypt and Mesopotamia certainly influenced the weight standards of many other cultures, such as populations in Syria and the Levant; in addition, the weight standards of one culture were in many cases easily converted to weight standards of another, likely on purpose in order to facilitate transactions between merchants of different cultural groups (seen, for example, in the similarity between the Egyptian *qedet* and the different shekels in use in the Near East and Levant) (Lassen 2000, 233-5, 237-8). Seagoing merchants seem to have carried several different weight standards on their voyages to facilitate such intercultural commerce (Pulak 2000b, 261). The weights of many archaeological finds of oxhide ingots are often fairly close to a 29 kg talent (see Pulak 2000a, 141-3; Buchholz 1959; Muhly 1979, 95; Budd et al. 1995a, 1); however, it is unlikely that there was a rough weight standard in ingot production at any time; variations in the weights of oxhide ingots from the Mediterranean show that they were not made to a strict weight standard and were likely weighed during each transaction (Pulak 1997, 238). Identifiable talent weights are also rare, perhaps because large, unworked stones, containers of sand, or other material measured using smaller weights were used as talent weights (Pulak 2000b, 263-4; cf. Lassen 2000, 240). A large stone excavated at the Late Cypriot site of Hala Sultan Tekke has been identified as a possible talent weight by P. Åström; it weighs about 27 kg and has an inscribed sign on it (Hult 1978, 78, 7). The fragments of deliberately broken copper ingots found on the Cape Gelidonya and Uluburun shipwrecks as well as in many Late Bronze Age scrap metal hoards could have aided in such weighing procedures; the ingot fragments could have served as ‘small change’ to add to given numbers of ingots during weighing in order to obtain the specific weight of metal needed for a commercial transaction. Scrap bronze or finished bronze or copper objects could have served the same purpose (this occurred at Kanish in the early second millennium B.C.), although bronze may have been considered more valuable because of its tin content (Derckson 1996, 46).

<sup>79</sup> EA 34: 16-25; EA 35: 10-5.

In EA 35, the king apologizes that this amount is “so small” since “the hand of Nergal is now in... [his] country”, and he cannot find “a single copper-worker”, but promises to send “whatever copper you, my brother, request.”<sup>80</sup> This statement implies that the smelting and refining of the copper occurred in his own territory, which, in turn, supports the identification of Alashia as Cyprus.<sup>81</sup> A fragmentary tablet (EA 36) mentions amounts of 120 or 70 units to be sent to Egypt in response to a request for copper, although the exact context of these figures is unclear.<sup>82</sup> In later letters smaller amounts of copper are exported to Egypt from Alashia; these seem to be closer to personal gifts than to large-scale commercial transactions involving bulk cargoes. In EA 37, the pharaoh receives five talents of copper and five teams of horses, along with a request for silver, while in EA 40 the king of Alashia complains that his gift of nine units of copper to a man named Sumitti (perhaps an Alashian diplomatic envoy or an Egyptian official) has not been reciprocated.<sup>83</sup> He sends the pharaoh five units of copper, three units of “fine copper”, ivory, a beam of boxwood, and one beam “for a ship” as his “greeting gift”.<sup>84</sup>

---

<sup>80</sup> EA 35: 10-5. It has been suggested that this amount is in fact 500 shekels (approximately 4.75 kg based on the Ugaritic shekel of approximately 9.5 g) or some other smaller unit of weight, but C. Pulak points out that a delivery of 500 talents of copper is well within the capability of some Late Bronze Age vessels, as shown by the Uluburun wreck’s cargo (Pulak 1997, 248; 2000a, 140). The name translated as ‘Nergal’ likely refers to a deity of pestilence, of West Semitic or native Cypriot origin (Moran 1992, 108). Hellbing (1979, 21-2) believes the name of this deity should be translated as ‘Reshef’, a native West Semitic god also associated with plague, war, and the underworld; the same logogram is used for both deities in cuneiform script, and the two names may have been epithets for the same god (Dalley 1987, 62, 64). Nergal may have been associated with smelting in the Near East at least by the first millennium (see Dalley 1987, 61-2, and Lambert 1991, 183-5, who oppose this theory). Another theory proposed by J. D. Muhly is that “the hand of Nergal” is simply an Akkadian expression for a particular disease and has no connection to worship of the deity on Cyprus (Muhly 1980a, 42).

<sup>81</sup> In the same letter, the king also requests payment for a shipment of timber to Egypt (EA 35, 27-9), which also suggests that Alashia has abundant timber for export, a resource necessary for smelting operations.

<sup>82</sup> EA 36: 6.

<sup>83</sup> EA 37: 8-12; EA 40: 6-15.

<sup>84</sup> Moran 1992, 113.

The correspondence between the rulers of Alashia and Egypt present a number of interesting facts. Alashia's gifts to the pharaoh are mostly raw materials—copper and timber—which would be consistent with a state less developed than Egypt in the 14th century B.C. Cyprus had relatively few large cities and towns in this period, and large parts of the island may have been sparsely settled, judging from archaeological finds.<sup>85</sup> Apparently, the king of Alashia has access to enormous amounts of copper, whose production he seems to control at least partially. The absence of copper ingots as an export product from other areas is significant; J. D. Muhly notes that “in some 400 Amarna letters Alashiya is the only country trading copper in a trade that seemed to involve considerable amounts of copper.”<sup>86</sup> The Amarna letters may also provide important evidence for the volume of Late Bronze Age copper trade. If the units of measure mentioned in the Amarna letters are talents, then the king of Alashia exported or planned to export up to 1,000 talents or 30 tons of copper to Egypt, certainly a huge amount of metal for the period.<sup>87</sup>

The scale of this transaction suggests to Panagiotopoulos (2001, 277-8) that these are commercial transactions between rulers rather than gift exchanges. For example, in EA 35 the king of Alashia asks for payment requested by some of his subjects for timber sent to Egypt: “...men of my country keep speaking with m[e] about my timber that the king of Egypt receives from me. My brother, [give me] the payment due.”<sup>88</sup> The Akkadian word *šīmātu* means “payment due”; this word

<sup>85</sup> For example, Raber's (1987) survey of the Polis region of western Cyprus uncovered little evidence of settlement until the Iron Age (299).

<sup>86</sup> Muhly 1982, 259.

<sup>87</sup> Hellbing 1979, 42.

<sup>88</sup> EA 35: 27-9.

never appears among the other Amarna letters documenting a gift-exchange and provides a clear indication of the commercial character of the activity. Furthermore, it is interesting to observe that this commercial transaction emerged at the level of royal correspondence only after becoming a political problem, as the words of the Cypriot ruler imply.<sup>89</sup>

In at least one other instance in the Amarna letters a clearly commercial transaction is discussed in which the pharaoh instructs a vassal to buy female slaves; the letter includes the number of slaves and the price to be paid for each in silver, an international standard of currency in the Bronze Age.<sup>90</sup> According to Panagiotopoulos, though “an indirect economic significance is undeniable” for gift exchanges, in part for diplomatic ties which could promote regular trade with foreign countries, “there seems to be no prevailing economic significance to diplomatic gift-giving”; therefore, diplomatic gift-giving and international trade were probably “two different spheres of exchange.”<sup>91</sup> Panagiotopoulos’ assertions seem to be correct for most of the exchanges detailed in the Amarna letters, although the exact economic significance of gift-exchanging expeditions themselves remains debatable. For example, the size of such expeditions and the possibly large amount of goods brought as trade items rather than diplomatic gifts is unknown. However, the lack of a clear division between ritual, commercial, and political concerns in the Amarna letters show that the system could be manipulated by participants for a variety of purposes.

Copper is frequently associated with Alashia in other textual references from the Bronze Age as well, many of them unrelated to gift exchanges between rulers. For

---

<sup>89</sup> Panagiotopoulos 2001, 278.

<sup>90</sup> Panagiotopoulos 2001, 277; Larsen 1976, 104.

<sup>91</sup> Panagiotopoulos 2001, 278.

example, two Hittite texts also seem to recognize Alashia as a source of copper.<sup>92</sup> Several references predate the foundation of large urban settlements of the Late Cypriot period by several centuries. Tablets from Ebla in Syria dating to the late third millennium B.C. mention the import of copper from Alashia.<sup>93</sup> A Babylonian text from the 18th century B.C. mentions twelve minas of ‘washed’ or purified copper from Alashia, while texts from Mari from the same period cite mines in Alashia, bronze from Alashia, and “copper from the mountain Alasia.”<sup>94</sup> The land of Isy, which appears in Egyptian tribute lists from late in the reign of Thutmose III, is mentioned as a source of large amounts of copper as well; Isy is often identified as another name for Alashia or Cyprus, although it may have instead been a separate land such as Assuwa in Anatolia, a territory appearing in contemporary Hittite texts.<sup>95</sup> The fact that these

---

<sup>92</sup> Alashia is mentioned in a Hittite ritual text describing the contents of a ritual foundation deposits laid before the building of a house. Each material’s source is mentioned; the list includes “Copper [and] bronze they brought from Mount Taggata in Alashiya” (Pritchard 1950, 356). A tablet from Boğazköy dating to the reign of Suppiluliuma II describes the defeat of the “king of Alasia” in a sea battle; copper is included in a list of war booty and in forced tribute to Hittite gods (see Güterbock 1997a, 193, 195). However, the amounts listed (four talents in all annually dedicated to four separate deities) seem small for a copper-producing center. It is likely that the text either describes the defeat of a ruler of *part* of Cyprus or that the Hittite victory was not as decisive as the text’s author claims; the offerings to Hittite gods could be part of a token payment of tribute to ensure peace with Hatti, rather than the results of a true ‘conquest’, as Güterbock has suggested (Güterbock 1997a, 193, 197).

<sup>93</sup> Maddin et al. 1983, 137.

<sup>94</sup> Hellbing 1979, 56-7; Millard 1973, 211-4; Muhly et al. 1988, 281. The reference to Alashia as a ‘mountain’ may be significant. One Hittite text seems to recognize a mountain in Alashia (*supra*. n. 92). Goren et al. (2003) point out that another text, a letter from an Alashian official to the king of Ugarit, indicates that seaborne raiders heading towards Ugarit had recently avoided his palace, perhaps the capital of the kingdom: “But now [the] twenty enemy ships—even before they would reach the mountain—have not stayed around but have quickly moved on” (250-1). Larsen (1976, 74-5) notes that Assyrian references to ‘washed’ copper most likely refer to refined copper, but that the term has also been used in a figurative sense in some texts to denote the cancellation of debts by a ruler.

<sup>95</sup> Hellbing 1979, 52; Muhly 1982, 259. The tribute lists come from accounts of Thutmose III’s campaigns in Asia. The first dates to the thirty-fourth year of his reign, when the main item of tribute received from a “chief of Isy” is “108 blocks of pure copper [or] 2,040 *deben*”; later tribute from Isy includes “crude copper [and] horses” and “forty bricks of copper” (Hellbing 1979, 52). One *deben* is approximately 94 grams, which would make the earliest recorded tribute about 191.76 kg of copper divided into ingots weighing approximately 1.7 kg each (Petrucci 1992, 6), unless Zaccagnini’s translation (1986, 414) of the passage as “108 ingots of copper and 2,040 *deben* of melted copper” is correct. This average weight is fairly consistent with the ‘slab’ ingots found on the Cape Gelidonya wreck and perhaps the MB I bar-shaped ingots found at ‘Ein Zeq and Be’er Resisim in the central Negev (Bass 1967, 82; cf. Segal et al. 1999, 179-80, 184). Muhly et al. (1980, 358) speculate that such ingots are secondary castings made in

texts predate the known large urban centers of Late Bronze Age Cyprus by several hundred years makes them problematic. The Cypriot cities of Enkomi, Kition, and Hala Sultan Tekke, as well as smaller settlements with substantial monumental architecture (for example, Kalavassos *Ayios-Dhimitrios*, Maroni *Vournes*, etc.), show the greatest degree of expansion in the LC II and LCIIIA period (c. 1450-1100); all oxhide ingots found in Cyprus and a large number from other areas date to this period.<sup>96</sup> Metallurgical evidence from the Middle Cypriot period contemporary with most of these texts consists mostly of funerary evidence, although these finds indicate that a large and sophisticated local bronze industry probably existed at or near the cemetery sites of Vounous *Bellepais* and Lapithos *Vrysi tou Barba* in northwestern Cyprus.<sup>97</sup> Copper and (later) bronze objects show a very limited range of types, consisting of weapons (hook-tang spearheads, axes, knives), tools (awls, chisels, scrapers), and personal items for adornment or cosmetic uses (needles, tweezers, pins, and rings).<sup>98</sup> Even after tin bronze becomes more abundant for some objects in the MC III period, it was never used for certain objects such as hook-tang weapons, scrapers, awls, tweezers, and pins.<sup>99</sup> This choice may have been dictated at least in part by cultural tradition, particularly in the case of the hook-tang weapons, which are common in burials and were probably important status symbols.<sup>100</sup> The metallurgical evidence shows that a productive though conservative metallurgical industry developed on the island by the Middle Cypriot period. Held (1993) has characterized

---

preparation for forging; in their analysis of two slab ingots from the Cape Gelidonya shipwreck, about 1.0 and 1.83% tin was discovered, suggesting that these ingots could have been made partially or wholly from remelted scrap copper or bronze. Such ingots could be made far from a primary copper-producing area from metal imported from a variety of sources, though other slab ingots were also found to contain impurities showing that they were made directly from smelted sulfide ores (Maddin and Wheeler 1976, 171-3).

<sup>96</sup> Muhly et al. 1988, 285, 292; Karageorghis 2002, 27, 71.

<sup>97</sup> Catling 1964, 55, 76-7.

<sup>98</sup> Balthazar 1990, 430-1.

<sup>99</sup> Balthazar 1990, 431.

<sup>100</sup> Balthazar 1990, 432.

Middle Bronze Age Cyprus as a “fertile backwater”, whose relative isolation and wealth in resources during the fourth and third millennium discouraged extensive foreign contacts (such as maritime trade), yet allowed Cypriot culture to develop into an independent and stable civilization.<sup>101</sup> Catling (1964, 76-7), on the other hand, characterizes the lack of change in Cypriot metal objects as “stagnation.” Some contact did occur, however; imported Minoan pottery occurs in MCIII/LC I levels at Toumba *tou Skorou*, and the design of some copper and bronze objects in Cyprus and the mainland show that metallurgists in Cyprus, Anatolia, and the Levant influenced each other in this period.<sup>102</sup> Although some Cypriot settlements from the mid-second millennium B.C. are currently under study, much more information is needed in order to understand the character of foreign contacts during this period and the influence of these contacts on metallurgy in Cyprus.<sup>103</sup>

One important question concerning the organization of the Cypriot copper trade in the Bronze Age is its degree of centralization. Was copper mining and smelting focused on a few localized mining areas subject to a strong central authority such as a “king of Alashia”, was it done by small, possibly itinerant groups of smelters or metallurgists who sent copper as tribute or exchanged copper for other goods in larger settlements, or did some combination of methods of labor organization supply copper to regional and international trade networks? In EA 35, the king of Alashia’s statement that he “cannot find a single copper worker” during a time of plague or war could be significant. The king’s comments suggest less than total control over copper production; his copper workers have apparently fled (into the mountains of the

<sup>101</sup> Held 1993, 26-7, 31.

<sup>102</sup> Vermeule 1990, 381-3; 1996, 52-3; Philip 1991, 69-99; Gale et al. 1996, 397-8, 400.

<sup>103</sup> Frankel 1993, 59-61, 69; Frankel and Webb 1996, 213-5; Gale et al. 1996, 359-60, 397-8, 400-2.

Troodos?) despite his desire to utilize them. F. Braudel has recognized that historically the inhabitants of mountainous areas are usually difficult to control politically; the mountains frequently serve as a refuge from political authority.<sup>104</sup> Perhaps Cypriot centers such as Enkomi or Kalavassos *Ayios Dhimitrios* exercised control over copper sources in only a limited fashion, such as an imposed annual tribute or occasional military or mining expeditions to the copper mines. This situation would be similar to Egyptian control over the Syro-Palestinian region during the New Kingdom period. During the reign of Tuthmosis III, for example, Egyptian armies forced Syro-Canaanite cities to pay them tribute and allegiance; towns which refused were sacked or had their surrounding lands pillaged.<sup>105</sup> Seizures of food supplies, ships, and settlements by the Egyptian army often occurred in foreign territory.<sup>106</sup> Huge amounts of metal were confiscated in military campaigns in Mesopotamia as well; one late third millennium B.C. inscription from Nippur records a donation to the Temple of Enlil of 3,600 minas of copper seized in a campaign.<sup>107</sup> Similar seizures may have occurred in Cypriot copper mining areas by armies from other parts of the island; these seizures may have begun in an ad hoc manner and later developed into organized tribute and/or occupation, as it did in areas of Syria-Palestine.<sup>108</sup> Shaw has noted the similarity of Egyptian military expeditions with mining and quarrying expeditions for stone and copper in Sinai and in Egypt's Eastern Desert, and has suggested that "mining officials were probably more usually defined by the Egyptians themselves as a subset of military or trading officials."<sup>109</sup> Miners, foremen, guards, officials, scribes, interpreters, and mineral prospectors seem to be among these groups, based on

<sup>104</sup> Braudel 1995, 31.

<sup>105</sup> See Pritchard 1950, 234-41, for contemporary Egyptian accounts of the campaigns of Thutmose III.

<sup>106</sup> Knapp and Cherry 1994, 132-3.

<sup>107</sup> Moorey 1994, 246.

<sup>108</sup> Redford 1992, 153-60, 192-207.

<sup>109</sup> Shaw 1998, 246.



inscriptions from Sinai left by Old Kingdom Egyptian turquoise mining expeditions.<sup>110</sup> These expeditions were large, often numbering in the thousands, but occasional, dispatched for specific materials only once every few years.<sup>111</sup> The New Kingdom period mines and other remains discovered at Timna are likely from such expeditions.<sup>112</sup> Logistically, they were well-organized; workers cut cisterns and established central supply stores in fortified camps; local Midianites seem to have been employed for some of the labor on the smelting sites as well.<sup>113</sup> Large numbers of these ‘Asiatics’ must have been involved in some expeditions, judging from individuals listed as ‘interpreters’ and ‘overseers of interpreters’ in several inscriptions left by Old and Middle Kingdom mining expeditions.<sup>114</sup>

Allowing for the very different environmental conditions of Cyprus, similar, though likely smaller, expeditions could have been sent annually from major cities on Cyprus to the ore-bearing regions of the island, perhaps conscripting local people to work in the mines or as smelters on a seasonal basis (this also seems to have occurred at Egyptian mines in Nubia).<sup>115</sup> Autonomous or semi-autonomous groups in the interior of Cyprus may have been unlikely to produce copper year-round for a distant ruler. Copper smelting on Cyprus could therefore have been a seasonal rather than a full-time operation: ethnographic examples of itinerant metalworkers and seasonal metalworking and related activities such as charcoal burning exist from Iran, central and eastern Europe, Germany, and Africa.<sup>116</sup> Such a workforce would be particularly

---

<sup>110</sup> Petrie 1906, 109-18; Mumford and Parcak 2003, 87.

<sup>111</sup> Petrie 1906, 109-21; Shaw 1998, 247, 250-2.

<sup>112</sup> Rothenberg 1972, 230, 233.

<sup>113</sup> Rothenberg 1972, 63, 230-4.

<sup>114</sup> Mumford and Parcak 2003, 87.

<sup>115</sup> Shaw 1998, 247.

<sup>116</sup> Forbes 1964, 9:62-3, 67-8, 94; Horne 1982, 11; Weisgerber 1982, 28; Childs 1998; Herbert 1998, 140, 145; Harding 2000, 235-7.

difficult to control during times of famine or war, which could explain the king's trouble with locating his copper workers.

The distinction made between 'copper' and 'fine copper' in these letters may also be significant. Copper is more easily obtained from some ores than others, and impurities in smelted copper are typically removed by roasting, remelting, and poling the impure metal one or more times (see Chapters IV and VII). Chalcopyrite ores, the most common copper ore on Cyprus, requires multiple roasts to remove sulfur from the ore before it can be smelted.<sup>117</sup> The method of repeated roasting before melting of copper ores could have been learned by Bronze Age smelters dealing with sulfide ores as well. Historically documented copper smelting procedures, such as those recorded in Georgius Agricola's *De Re Metallica* (1556), describe how copper sulfide ore was roasted in large pens or piles by building a fire on the ore; this process converted the copper sulfides to copper oxides (although the process was rarely complete),<sup>118</sup> as well as aiding in breaking up the ore into smaller pieces.<sup>119</sup> Agricola states that this process was repeated once, twice, or as many as seven times, depending on the type of ore smelted, before ingots were produced.<sup>120</sup> The amount of impurities and inclusions remaining in an ingot depends on the extent to which it was refined.

Copper seems to have been traded in different purities in the Near East during the Bronze Age. Leemans (1960) notes a reference to "copper of the mountains" in a Bronze Age text from Mari, and suggests that this term refers to copper "of an impure

---

<sup>117</sup> Tylecote 1982, 97, 99; Maddin 1988, 172.

<sup>118</sup> Maddin et al. 1983, 133.

<sup>119</sup> Hoover 1950, 273-5, 278-9, 349-50; Muhly 1973a, 171.

<sup>120</sup> Hoover 1950, 274, 349-51.

quality”, probably matte or blister copper.<sup>121</sup> Assyrian merchants trading in Anatolia recognized many varieties of traded copper; two general categories recognized by these merchants were ‘good’ and ‘bad’ copper in their economic documents (see Table 1), along with more unusual references such as “copper which does not contain hematite.”<sup>122</sup> This probably indicates partially refined copper smelted from sulfide ores; hematite is a mineral commonly found in weathered copper ores, and iron is also a major impurity in copper sulfide ores such as chalcopyrite ores.<sup>123</sup> Oxhide ingots physically and chemically resemble what is known as blister copper, copper smelted from iron sulfide ores that include blowholes and gas porosities as well as residual impurities in the metal; however, chemical analysis of oxhide ingots have consistently shown that they are of a high purity (usually 98 to 99% copper), which shows that they must have been made from copper that have been remelted at least once.<sup>124</sup> Iron is the major impurity in copper ingots from the Uluburun ship, indicating they were probably smelted from copper sulfide ores.<sup>125</sup> ‘Fine copper’ possibly refers to a more refined product, while ‘bad’ or ‘impure’ copper could refer to matte, a compound of copper and impurities (chiefly iron, silicates and sulfur) produced directly from a smelt of copper sulfide ores, or ‘black copper’, a less refined copper derived from matte.<sup>126</sup>

---

<sup>121</sup> Leemans 1960, 122.

<sup>122</sup> Forbes 1964, 9:93; Larsen 1976, 91-2.

<sup>123</sup> Craddock 1995, 28; Muhly 1973a, 171-2;

<sup>124</sup> Muhly 1973a, 172; 1979, 92; Muhly et al. 1980, 90, 93; Tylecote 1982a, 94; Muhly et al. 1988, 287-8; Begemann et al. 2001, 50; Hauptmann et al. 2002, 13-5.

<sup>125</sup> Hauptmann et al. 2002, 7, 12-3, 17-8.

<sup>126</sup> Muhly 1973a, 172; Forbes 1964, 9:19, 40. Matte typically contains at least 30-50% copper, along with impurities such as sulfur, iron, lead, zinc, silver, antimony, and arsenic, while black copper contains 95-99% copper with impurities of copper oxides and various elements (Forbes 1964, 9:40).

Table 1. Descriptive Terms for Copper in Assyrian Texts from Kaniš/Kültepe (After Derckson 1996, 33-43)

<b>Assyrian Term:</b>	<b>Translation:</b>	<b>Quality/Price:</b>
<i>werium</i> /URUDU	Generic term for copper; possibly a term for a specific quality of copper in some cases. Also used to refer to lumps of native copper.	(Derckson 1996, 33-4)
<i>dammūqum</i>	‘fine’; can denote “raw copper, unrefined but of high quality, and refined copper.”	High (50-73 shekels of copper per shekel of silver) (Derckson 1996, 35-6).
<i>masium</i>	‘refined’ or ‘washed’	High (45-71 shekels of copper per shekel of silver).
<i>zaku’um</i>	‘clean’	Good quality? No prices known (Derckson 1996, 36).
<i>watrum</i>	‘excellent’	High (occurs in combination with <i>dammūqum</i> ). No prices known (Derckson 1996, 36).
<i>lammunum</i>	‘poor’; ‘of bad quality’; ‘raw copper’ (copper with impurities such as iron)	Fair to poor (sold at 80 shekels of copper per shekel of silver) (Derckson 1996, 37).
<i>massuhum</i>	‘dirty’; metal with visible impurities?	Low (not acceptable as payment to some traders) (Derckson 1996, 37)
<i>sallāmum</i>	‘black’ (similar to <i>massuhum</i> ); possibly covered with black iron scale or other impurities	Low (as with <i>massahum</i> ) (Derckson 1996, 37-9).
<i>ša masā’im</i>	‘which has to be refined’	Low (Derckson 1996, 39)
<b>Terms for the Shape and Form of Copper:</b>		
<i>sahhirum</i>	‘small-sized’ (pieces of copper ingots?)	(Derckson 1996, 40)
<i>šabburum</i>	‘broken’; copper consisting of broken-up ingot fragments	(Derckson 1996, 40-1)
<i>hassu’um</i> <i>ša šaduīšu</i>	‘copper in pieces’ or ‘scrap’? ‘native copper’ or copper ore	(Derckson 1996, 39-40) (Derckson 1996, 41-2)
<i>šikkum</i>	“A primary smelting product containing many impurities”, possibly already in fragments; possibly “in a characteristic shape”	Varies (one reference known to “good quality <i>šikkum</i> ), but typically poor; its value was typically “one-half to one-third of that of fine quality copper” (Derckson 1996, 42-3).

TABLE 1, continued

<b>Assyrian Term:</b>	<b>Translation:</b>	<b>Quality/Price:</b>
<i>hušā'ū</i>	Scrap copper, bronze, or silver	High (due to purity); traded only in small quantities, probably for local use; not transported over long distances (Derckson 1996, 45-7).
<i>šaršarretēn/URUDU</i>	“copper in the shape of two chains”	(Derckson 1996, 33).

In his analysis of Assyrian texts from Kültepe, Derckson (1996) distinguishes additional categories of copper in the copper trade in Anatolia. Several terms are used to distinguish between different qualities of copper; some are called “fine”, “excellent”, etc. (see Table 1), while others are “bad”; the latter is traded in larger amounts for the former in some cases, and the lowest, most impure qualities of copper were not always considered acceptable as payment for other goods.<sup>127</sup> Some varieties of copper are referred to with a toponym, indicating the origin of the copper in specific local deposits, or else locations in which copper from other sources were collected and refined.<sup>128</sup> Certain localities seem to have had a reputation for producing copper of superior purity; for example, copper from Haburata and Purušhattum sell for much higher prices than copper from Kunanamit and Tišmurna.<sup>129</sup> Some localities, such as the “country of Sawit”, seem to have produced copper of both “fine” and poor quality, perhaps indicating that these were important mining regions, while other copper-producing localities are mentioned only once or a few times and seem to produce only small amounts of copper, suggesting that small local deposits were being exploited.<sup>130</sup>

<sup>127</sup> Derckson 1996, 37-9.

<sup>128</sup> Derckson 1996, 43.

<sup>129</sup> Derckson 1996, 43-5.

<sup>130</sup> Derckson 1996, 43-5.

Scrap bronze and copper (*hušā'ū*) also circulated, typically as complete or fragmentary metal tools (particularly sickles, hammers, and axes); the sickle seems to have been recognized as a discrete unit of exchange.<sup>131</sup> Bronze scrap was typically traded in small amounts from a few shekels to up to thirty or forty minas, judging from surviving textual references.<sup>132</sup> Although scrap copper and bronze fetched high prices, there seems to have been no large-scale trade in scrap metal in this region when compared to the trade in unworked copper.<sup>133</sup> Derckson suggests that “Most recycling of copper will have happened within a small area, like a city or village, where someone would bring old copper implements to a local smith, and have new tools made out of them;” however, small amounts of scrap were carried with merchants traveling to Assur, “probably to be used as a means of exchange” to pay traveling expenses. A similar term translated as ‘loose tin’ by Veenhof (1972), seems to refer to small amounts of tin carried by merchant caravans and used for the same purpose.<sup>134</sup>

#### *Copper Ingots in Egyptian Texts and Tomb Paintings*

Several New Kingdom period tomb paintings and reliefs include representations of copper oxhide ingots. These discoveries, along with four miniature oxhide ingots inscribed with hieroglyphs discovered in temple foundation deposits at Thebes, show that the Egyptians were familiar with this ingot form.<sup>135</sup> These representations date from the 15th to the 12th century B.C.<sup>136</sup> Inscriptions accompanying New Kingdom tribute scenes show that the Egyptians recognized a difference in terminology between

<sup>131</sup> Derckson 1996, 45, 47.

<sup>132</sup> Derckson 1996, 46.

<sup>133</sup> Derckson 1996, 46.

<sup>134</sup> Derckson 1996, 46-7; Veenhof 1972, 257.

<sup>135</sup> Bass 1967, 62-7; O'Connor 1967, 172-4. A quarter of an oxhide ingot was found at the site of Qantir in the Nile Delta as well (Gale and Stos-Gale 1999, 272).

<sup>136</sup> Bass 1967, 62-7.

the shape of oxhide ingots and rectangular or oval-shaped ingots (although the latter are either lead, tin, or silver in these scenes judging by their color).<sup>137</sup> Egyptian representations and models of oxhide ingots all occur in elite contexts, on reliefs and in foundation deposits in temples, as at Karnak and Medinet Habu or, most commonly, in tomb paintings from the tombs of important officials at Thebes and Amarna.<sup>138</sup>



**Figure 2: Oxhide ingot bearer from ‘Keftiu.’ Tomb of Rekhmire, mid 15th century B.C. (After Davies 1973, Pl. XIX).**

Frequently foreigners are depicted carrying oxhide ingots. These items are always listed as ‘tribute’, although they may instead have been commodities used in trade or gift-exchange networks involving foreign rulers and elites.<sup>139</sup> The foreigners are most

<sup>137</sup> Muhly 1973a, 245.

<sup>138</sup> Bass 1967, 62-7; Panagiotopoulos 2001, 263-4.

<sup>139</sup> Bass 1967, 62-7; Pritchard 1950, 248. An alternate translation of the Egyptian word *jnw*, frequently translated as ‘tribute’, has been proposed by several scholars, who translate it as ‘gift’ (literally, “that which is brought”) (Panagiotopoulos 2001, 270-1). Offerings from both peoples ruled by Egypt (Nubians, Syrians) and peoples independent of Egypt (Hittites, men of Mitanni, etc.) are recorded as carrying *jnw*, suggesting that the Egyptians made no distinction in their language between tribute and diplomatic gifts, although the distinction is made in Akkadian (Panagiotopoulos 2001, 268, 270).

often identified as “men of Retnu” (Syria) or “the chiefs of Retnu and all the lands of further Asia.” Other foreigners in the Tomb of Rekhmire (c.1469-1411 B.C.) are described as “the chiefs of Keftiu land (and) the islands which are in the midst of the sea” (Figure 2).<sup>140</sup> When the figures in the paintings are not labeled, they can often be identified as foreigners by their distinctive dress: ‘Asiatics’ have beards and dress in robes, while ‘men of Keftiu’ are colored red-brown, are clean-shaven, and wear distinctive hairstyles, loincloths, and footwear.<sup>141</sup> However, in some cases these identifications may be problematic. Bass proposes that later representations of oxhide ingots could be apocryphal; in at least one case a relief from a pharaonic temple that includes oxhide ingots may have been copied from an earlier temple relief.<sup>142</sup> Such inaccuracies are not unprecedented in Egyptian temple reliefs and inscriptions.<sup>143</sup> The probable use of pattern books by Egyptian tomb painters, who at times mixed aspects of dress and physical features of different ethnic groups in the appearance and costume of a single individual, may have also misled scholars studying foreign trade with Egypt. In some cases, at least, the painters probably had never seen the foreigners they were representing in their paintings.<sup>144</sup> In at least one case, the Tomb of Amenemopet at Thebes, oxhide ingots are carried by ‘hybrids,’ or figures combining generic

<sup>140</sup> Bass 1967, 62-3; Pritchard 1950, 243-4, 248-9.

<sup>141</sup> Wachsmann 1987, 31, 41-6.

<sup>142</sup> Bass 1967, 67. The possibly apocryphal scenes date to the reign of Ramesses III (c. 1200 B.C.); Egyptian representations of oxhide ingots disappear in the 12th century BC (Bass 1967, 164). The latest oxhide ingot representation occurs in the reign of Ramesses IV (S. Wachsmann, personal communication). However, archaeological evidence from Cyprus and Sardinia indicate that oxhide ingot production likely continued into the 12th century B.C. (see Chapter VIII), although the copper may not have been reaching Egypt in significant quantities. A single copper oxhide ingot fragment sourced to the Apliki mining region in northwest Cyprus was excavated on the 13th century Egyptian site of Qantir in the Nile Delta (Gale and Stos-Gale 1999, 272).

<sup>143</sup> One text from the reign of Sheshonk I (c. 945-24 B.C.) claims that the kingdom of Mitanni as the vassal of Egypt, when in fact Mitanni had collapsed four hundred years earlier (Pritchard 1950, 263-4). Strange (1980) lists references to Alashia in Egyptian sources of the first millennium B.C. and first millennium A.D., some of which may be apocryphal.

<sup>144</sup> Wachsmann 1987, 6-9, 12-3.



features of several different foreign ethnic groups.<sup>145</sup> The re-use and modification of certain stock scenes, including tribute processions, is another characteristic of these tomb paintings. In some cases objects are transferred; this ‘transference’ may insert apocryphal or historically inaccurate elements into such scenes.<sup>146</sup> Wachsmann proposes that the oxhide ingots carried by Aegean figures in the Tomb of Rekhmire may be ‘transferred’ objects. The Aegean ingot-bearers are shown in a similar position in the Aegean tribute scene as in the Syrian tribute scene in the same tomb, and while this scene is the only depiction of Aegeans with oxhide ingots, several other representations of Syrians with ingots are known.<sup>147</sup> The identification of oxhide ingots as ‘Keftiubarren’ (a term coined by H.-G. Buchholz in 1959), whose manufacture and trade was dominated by Aegeans has a long history in Mediterranean archaeology, but has little solid evidence to support it when compared to evidence of Cypriot and Levantine connections.<sup>148</sup> Oxhide ingots were certainly available to the Minoans (numerous oxhide ingot finds occur on Crete), but whether they were ever transported to Egypt by Minoans is unknown. Judging from archaeological evidence, a Syrian or Cypriot domination of the oxhide ingot trade seems more likely, although Minoans certainly could have certainly brought commodities to Egypt which they themselves had imported.<sup>149</sup>

One tomb from Thebes dating to the reign of Amenhotep II, the Tomb of Nebamun, has the most convincing direct association of ‘Asiatics’ in Egypt involved with oxhide

<sup>145</sup> Wachsmann 1987, 50, Pl. LII: B.

<sup>146</sup> Wachsmann 1987, 9-13, 50.

<sup>147</sup> Wachsmann 1987, 50-1, Pl. XLI, XLIV.

<sup>148</sup> Wachsmann 1987, 51; Buchholz 1959, 1; Bass 1967. See also Chapters III, VIII, and Appendix 1 for evidence of oxhide ingot trade and production in Cyprus and the Levant.

<sup>149</sup> Wachsmann 1987, 51-2, 119; see also Chapters V and VI.

ingots in small-scale, unofficial trade in copper in this period, as opposed to ‘tribute’ scenes of royal trade or gift exchanges.<sup>150</sup>



**Figure 3: The Egyptian physician Nebamun receiving a high-status Syrian. An oxhide ingot (right) is part of the Syrian’s payment to Nebamun for his services. Detail from the Tomb of Nebamun, Thebes (After Säve-Söderbergh 1957, Pl. XXIII).**

In one scene Nebamun, a physician, receives goods from a rich Syrian, presumably as payment for his services. Part of his gift or payment is an oxhide ingot (Figure 3).<sup>151</sup> This ingot representation is unique in Egyptian references in that it does not appear in a context directly associated with the state; it can therefore be interpreted as an example of small-scale private trade in copper similar to examples from elsewhere in the Near East. Oxhide ingots also occur in Egyptian iconography as captured war booty from Retnu, as items in royal storehouses, and as archery targets for several pharaohs, including Thutmose III (c.1479-1425 B.C.), who is claimed to have shot

<sup>150</sup> Wachsmann 1998, 46.

<sup>151</sup> Wachsmann 1998, 45-6; Bass 1967, 65.

through an oxhide ingot “three fingers in thickness”.<sup>152</sup> A similar feat is claimed for the pharaoh Amenhotep II (c.1427-1400 B.C.), who is said to have fired arrows through “four targets of Asiatic copper... one palm in their thickness;” the inscription accompanies a relief of the pharaoh firing arrows through an oxhide ingot.<sup>153</sup> The stated thicknesses of these ingots are roughly comparable or slightly thicker than known archaeological examples of oxhide ingots, although the writer may be exaggerating their thickness for effect.<sup>154</sup> This statement suggests the possibility that the scribe had actually seen an oxhide ingot, unlike the artists who painted the Theban tomb scenes, who show little or no indication of having seen the actual foreigners and foreign goods that they depicted, though the scenes themselves likely took place.<sup>155</sup>

Egyptian sources clearly show that oxhide ingots are recognized as foreign imports, usually brought by Syro-Canaanites, but in one case carried by “men of Keftiu”, perhaps Minoans.<sup>156</sup> This identification is based on the dress and hairstyles of the figures as well as some demonstrably Aegean goods they carry, such as ‘Vapheio’ style cups. Many of the other goods carried by the foreigners, however, are more likely of non-Aegean or even Egyptian origin, which once again suggests that the

<sup>152</sup> Pritchard 1950, 243; Davies 1935, 51; Bass 1967, 64, 66.

<sup>153</sup> Davies 1935, 49, 51; Pritchard 1950, 244; Bass 1967, 64-5.

<sup>154</sup> Pritchard 1950, 243-4; Bass 1967, 53, 57. The Uluburun shipwreck’s oxhide ingots range in thickness from approximately 1.3 to 7 cm, and on average are about 3-4 cm thick. They are frequently thickest at the ends of the handles where these are well-preserved. Davies (1973, 21) notes that in Egyptian tomb paintings, oxhide ingots are “usually not colored a uniform pink but are given blue or red specks (oxidation or impurities?).” Such impurities, consisting of slag and ore chunks and charcoal pieces are in fact visible on the surfaces of oxhide ingots. Details of the thickness and textures of oxhide ingots suggests that the artists who painted these scenes had first-hand knowledge of the appearance of oxhide ingots, which, in turn, suggests that they were relatively common in New Kingdom Egypt.

<sup>155</sup> Panagiotopoulos (2001, 269-70) notes that participation in the receiving of foreign envoys would have been considered a great honor by Egyptian officials, hence, the recording of the scenes in the officials’ tombs as significant events in the lives of the deceased.

<sup>156</sup> Wachsmann 1987, 50, 98-9, Pl. LIV; Muhly 1979, 89.

Egyptian artists were not working from first-hand knowledge of these objects.<sup>157</sup> First-hand experience with Minoans could have been obtained during this period in Egypt, however; early 18<sup>th</sup> Dynasty (c. 1550-1500 BC) finds from Tell el-Dab'a include fresco fragments painted in a clearly Minoan style, solid evidence for the presence of Minoan craftsmen living within Egypt.<sup>158</sup> Other possible Minoan artifacts from 16th century BC contexts occur at Tell el-Dab'a, as well as Minoan Kamares Ware dating to the first half of the 18th century BC.<sup>159</sup> The period of this association lasts from the reigns of Hatshepsut to the early part of Amenhotep II (c. 1500-1450 B.C.), after which authentic depictions of these foreigners seem to disappear from the iconographic record.<sup>160</sup>

Egypt was not without its own copper sources. Evidence of Egyptian copper smelting dating as early as the Old Kingdom period occurs in Egypt's Eastern Desert, Sinai, and on the Nubian border.<sup>161</sup> These, however, may not have always been adequate for the needs of the state and large-scale importation of copper may have been necessary in certain periods, as indicated in the later Amarna letters from Alashia.<sup>162</sup> The relationship between the 'men of Retnu', the 'men of Keftiu', and Cyprus is unclear, but archaeological evidence such as Cypriot pottery on LBA Syro-Canaanite sites indicate that strong trade connections existed between Cyprus and the Levant in this period; large amounts of Mycenaean and some Minoan pottery appear in Cyprus as

<sup>157</sup> Wachsmann 1987, 52-72.

<sup>158</sup> Bietak 1995, 23-6.

<sup>159</sup> Bietak 1995, 19-21.

<sup>160</sup> Wachsmann 1987, 103-4. The absolute dates of these reigns depend on which Bronze Age chronology is used; for a summary of chronological problems involving the absolute dating of the reigns of Egyptian pharaohs, see Kitchen 1987; 1991, and Cline 1994b, 5-8. For an overview of archaeological evidence for Minoan trade with Egypt, see Warren 1995.

<sup>161</sup> Shaw 1998, 243-4; Lucas and Harris 1999, 201-9; Ogden 2000, 150-1.

<sup>162</sup> Muhly 1973a, 217-20.

well, although most date to a later period.<sup>163</sup> If the ‘men of Keftiu’ were Minoans and the ‘Retenu’ were from Syria-Palestine, then any copper they possessed was almost certainly obtained from outside their homelands (see Chapters V and VIII).

*Textual Evidence for Organized Metalworking in Mycenaean and Syro-Palestinian States*

1) Pylos and Knossos

Textual references to metals and metalworking also occur in Mycenaean Linear B tablets dating to the Late Bronze Age. However, these texts do not directly involve copper production or trade, but rather the organization of copper or bronze smiths in the Mycenaean palaces. Texts dating to c. 1200 B.C. from the palace of Pylos in southern Greece indicate that the palace controlled a large bronze-working industry in the region; records indicate that three to four hundred copper workers were employed by the palace.<sup>164</sup> These smiths used large amounts of metal, perhaps as much as 1,046 kg according to one estimate.<sup>165</sup> The tablets list the number of smiths at various locations and the amount of bronze issued to each, as well as lists of smiths alone.<sup>166</sup> The smiths were issued amounts of metal ranging from approximately 1.5 to 12 kg each, either to produce finished products needed in each local area or to fill orders for

<sup>163</sup> Muhly 1985b, 23-30.

<sup>164</sup> Ventris and Chadwick (1973, 509) estimate that the smiths in the Pylos tablets number “about 270, not counting the slaves;” therefore, the total number of smiths in the Pylian kingdom would amount to about 400.

<sup>165</sup> Chadwick 1976, 140. While this is a significant amount of metal, this weight represents only a fraction of the total weight of copper on the Uluburun wreck. An estimate of 30-50 oxhide ingots seems reasonably close to the total amount of metal issued in these documents (1046 kg = approximately 36 talents of 29 kg each). About one-third of the Jn series tablets from Pylos, which list the smiths and their metal allocations, are missing or too badly damaged to be legible, so the total amount of metal issued was probably larger (Ventris and Chadwick 1973, 508).

<sup>166</sup> Chadwick 1976, 140.

large numbers of finished objects required by the palace.<sup>167</sup> The most common amounts issued to smiths are 1.5 kg and 3-4 kg.<sup>168</sup>

Many of the smiths listed are not issued metal, however; M. Ventris and J. Chadwick, the translators of the tablets, believe this was due to a massive shortage of metal in the kingdom, probably related to the social upheavals that occurred around 1200 B.C. in the eastern Mediterranean.<sup>169</sup> In 829, a tablet which lists the contributions by dozens of Pylian officials of relatively small amounts (51 kg in all) of “temple bronze as points for darts and spears”, is interpreted by Ventris and Chadwick as the collection of scrap bronze in the form of “dedicated objects, often old and useless, found in religious buildings” to make weapons to fend off an impending attack.<sup>170</sup> Whether such collections were standard practice or occurred only in extraordinary circumstances is unknown. However, in the Bronze Age and later periods the practice of digging *bothroi* or *favissae*, or pits to contain older dedications which had accumulated in sanctuaries, was a common method of disposing of older dedications; perhaps metal objects were melted down for the profit of the temple rather than buried.<sup>171</sup> Since other passages in the Pylian Linear B texts seem to indicate other preparations for an attack, such as the mustering of warship crews and lookouts, Ventris and Chadwick’s theory remains plausible.<sup>172</sup> Even the small amounts of bronze collected by the Pylian officials and allocated to the smiths could be used to

<sup>167</sup> Chadwick 1976, 140; Ventris and Chadwick 1973, 355-6.

<sup>168</sup> Ventris and Chadwick 1973, 356.

<sup>169</sup> Ventris and Chadwick 1973, 355-6, 513.

<sup>170</sup> Ventris and Chadwick 1973, 357-8, 513. An alternate translation of the word “temple” in Jn 09, however, is “ship”, which would significantly change the sense of the passage (indicating it was copper imported by sea?) (Ventris and Chadwick 1973, 357).

<sup>171</sup> Karageorghis 2002, 192-3; Karageorghis and Demas 1985, 246-7, 279. Metal votive objects were buried or left in sanctuary sites in the eastern Mediterranean, however; for example, cave-sanctuaries on Crete, the Temple of Hathor at Timna, and early Iron Age *bothroi* at Amathus and Kition (Karageorghis and Demas 1985, 279; cf. Rothenberg 1988, 29; Karageorghis 2002, 137).

<sup>172</sup> Wachsmann 1998, 159-61.

make large numbers of weapons.<sup>173</sup> Whether the Linear B tablets describe the normal functioning of Pylian metalworkers or activity during a period of unrest or crisis remains unresolved.

The Pylos tablets also provide clues on the status and organization of smiths in the Mycenaean palace system. They are obviously valued craftsmen, some of whom owned slaves, and they seem to have lived in fairly large groups:

... one can scarcely credit that so large a number would have been needed for domestic purposes. Unlike the village smith of medieval and modern times, they are not scattered throughout the settlements, but are concentrated in groups of up to 26 or 27,... in places, scarcely half of which are mentioned again in the Pylos archives. It would seem likely that they were located near good supplies of timber for use as fuel, and perhaps on hill-tops where the wind would supply necessary draught for their furnaces.<sup>174</sup>

The smiths may have been organized along clan or family lines; some headings in the In tablets “look more like clan names than place names, possibly suggesting small closed communities of tinkers.”<sup>175</sup> They also seem to have been exempted from certain types of tribute more often than any other craft profession listed in the tablets; they were given allowances of thread, linen, and other materials possibly used in the production of composite metal objects (such as shields or armor), or simply received as additional payment for their services.<sup>176</sup> The smiths may have worked full- or part-

<sup>173</sup> Ventris and Chadwick (1973, 356) estimate that 1.5 kg of copper or bronze could make 1,000 arrowheads of a type excavated from Knossos, and 5 kg could be used to make 14 swords or spears; therefore, the total weight of bronze on the tablets could be used to make 534,000 arrowheads, 2,300 swords and spears, or 1,000 bronze helmets.

<sup>174</sup> Ventris and Chadwick 1973, 509.

<sup>175</sup> Ventris and Chadwick 1973, 135.

<sup>176</sup> Ventris and Chadwick 1973, 135, 298-9.

time, perhaps using the time they were not smithing to grow their own food.<sup>177</sup> Such a pattern of production is well known from ethnographic examples of mining and smelting in traditional African societies.<sup>178</sup>

Other possible evidence for a distinctive class of smiths at Pylos is the existence of a goddess called Potnia, likely a patron deity of smithing according to Ventriss and Chadwick; similar connections between religion and metallurgy have been postulated at Bronze Age sites such as Arkalokhori Cave on Crete, Enkomi and Kition on Cyprus, and Ras Ibn Hani in Syria.<sup>179</sup> However, various ethnographic accounts show that complex religious beliefs connected with metallurgy may involve highly organized production but do not necessarily require it to develop.<sup>180</sup> Although Ventriss and Chadwick believe that the cult of Potnia “cast[s] further doubt on the suggestion that the smiths were part-time or seasonal workers”, S. T. Childs’ account of early 20th-century iron mining among the Toro in Uganda is one example of a society where metallurgy is highly valued and religiously significant but where the exploitation of iron resources is clan-based, seasonal, and decentralized in comparison to the bureaucracy and central control of the smiths apparent in the Linear B tablets.<sup>181</sup> However, ethnographic accounts of African metallurgical practices also show some correlation between the difficulty of the mining in particular regions and the complexity of ritual beliefs connected with metallurgical operations in these

---

<sup>177</sup> Ventriss and Chadwick 1973, 123, 352.

<sup>178</sup> Herbert 1998, 145, 149.

<sup>179</sup> Ventriss and Chadwick 1973, 509; Robertson 1978; Dalley 1987; Lambert 1987; Karageorghis and Demas 1985, 249, 253-4; Westover 1999.

<sup>180</sup> Herbert 1998; Forbes 1964, 8:71-82; Dalley 1987; Childs 1998.



societies.<sup>182</sup> Perhaps the difficulty in obtaining metals would have raised the status of smiths in the kingdom of Pylos.

Several damaged Linear B tablets from Knossos (Oa 730, 733, and 734) dating to before 1400 B.C., or two centuries before the Pylos tablets, also record metal oxhide ingots, probably of copper; they are represented in the Linear B script by an oxhide ingot-shaped ideogram, translated as a ‘talent’ of metal.<sup>183</sup> Sixty ingots are listed with a total weight of approximately 1,562 kg (at an average of 26.03 kg each, a plausible average weight for a group of oxhide ingots).<sup>184</sup> However, the use of recycled metal probably occurred here as well as at Pylos.<sup>185</sup> The Knossos tablets show that Knossos imported large amounts of metal, most likely copper, in ingot form, probably from the primary source. This is not surprising, considering the extensive remains of metallurgical workshops at Knossos and other sites.<sup>186</sup> Chadwick’s theory that shrines contributed bronze objects for weapons production, whether routinely or in a time of crisis, remains plausible regardless of the translation of the tablet; at least a portion of the copper and bronze used by Mycenaean smiths appear to have been scrap metal

---

<sup>181</sup> Ventris and Chadwick 1973, 509; Childs 1998, 124, 127-8, 130, 132-3.

<sup>182</sup> Herbert 1998, 150.

<sup>183</sup> Bass 1967, 68; Buchholz 1959, 17; Chadwick 1976, 102-3, 142; Muhly 1979, 93; 1980, 43-4; Petruso 1992, 18-9. The sign for copper is preserved on only one tablet, however (Chadwick 1976, 142). The ‘talent’ designation is based partly on Evans’ interpretation of a large pierced stone decorated with an octopus in relief found at Knossos; this stone weighs 29 kg, or one talent, and was thought by Evans and others (e.g., Chadwick) to be a talent weight (Chadwick 1976, 102-3, 142).

<sup>184</sup> Chadwick 1976, 142; Pulak 2000a, 143.

<sup>185</sup> Chadwick 1976, 141; Karageorghis and Kassianidou 1999, 184.

<sup>186</sup> Hakulin 2004, 6, 20-3, 38-45.

from old or worn-out tools and weapons or from votive or funerary objects removed from temples, looted graves, and other sources.<sup>187</sup>

## 2) Alalakh

Cuneiform tablets from the Assyrian city of Alalakh dating to the 15th century B.C. record evidence of highly organized copper production similar to that in Pylos two hundred years later.<sup>188</sup> The tablets record the completion of orders for specific metal objects, such as bronze chains weighing 2,750 shekels (or about 26.125 kg) “which were sent from the town Zalhe” (396), bronze doors, and arrowheads, as well as the issuance of various amounts of copper typically ranging from a few to up to fifty talents.<sup>189</sup> These amounts of metal are issued to individuals, some of whom have

<sup>187</sup> Chadwick 1976, 142; Karageorghis and Kassianidou 1999, 184-5. Weeks (2003, 141-2) has proposed that grave-robbing was a major source of metal in southeastern Arabia during the Bronze Age and subsequent periods: “[T]he need for new metal may have been ameliorated by grave robbing: it is clear that prehistoric graves in the region were frequently robbed in antiquity for the metal objects they contained, as can be seen on the rare occasions when unrobbed tombs are discovered” (Weeks 2003, 141). A cache found in a tomb in the mountains of Oman known as the Selme hoard contained over 600 metal objects ranging in date from the third to first millennium B.C.; it was likely deposited in the tomb by a tomb robber of the late second or first millennium B.C. (Hauptmann et al. 1988, 46). Similar activity likely occurred on Mediterranean Bronze Age sites as well. Karageorghis and Kassianidou (1999, 172), propose that Tombs 4 and 5 at Kition, dating to the 14th or 13th century B.C., were looted for metal objects a century later based on the complete absence of metal objects in an otherwise rich grave assemblage; the metallurgical workshop at Temple 1 may have been fueled partly by such looting. Similar evidence occurs from contemporary elite tombs at Kalavassos *Ayios Dhimitrios*, particularly at Tomb 13, where “many metal objects” were likely removed in antiquity by looters while other luxury goods, such as Mycenaean kraters, alabaster, and some gold and lapis lazuli jewelry that were missed by the looters were found (South 1997, 163-5). Objects robbed from Egyptian tombs may have been traded for Minoan and Mycenaean imports as well; Early Dynastic stone bowls and other objects have been discovered in Late Bronze Age contexts at Knossos and other sites (Pomerance 1975, 22-5, 27-30). These examples show that recycled metal from graves, tombs, and other sources was in widespread circulation. High tin content in some slab ingots from the Cape Gelidonya wreck suggests that scrap bronze was sometimes remelted into the form of small ingots (Muhly et al. 1977, 357-8).

<sup>188</sup> Wiseman 1953, 1-2, 105-6.

<sup>189</sup> Wiseman 1953, 105-6. The calculation of the total weight of the chain is based on the Ugaritic shekel of about 9.5 g (Pulak 2001, 248). Similar weight standards existed throughout the Near East, Egypt, and the eastern Mediterranean in the Bronze Age; these ‘shekels’ range in weight from approximately 8.4-11.75 g (see Lassen 2000, 233-41).

offices mentioned in the text (for example, “two talents for the governor of the town of Berašena”), while other amounts are specified for groups of smiths (for example, “three talents of copper, plus 1,200 [shekels] for the smiths of Berašena”).<sup>190</sup> Like the smiths of Pylos, the Alalakh smiths seem to have been organized into separate communities outside the main city, judging from the localities named in the texts (“smiths of Berašena”).

Copper also seems to have been used as a form of currency to pay travel expenses, as one tablet (403) shows: “Receipt for 20 [?] talents of copper from the palace received by Birriaššuwa son of Irip-šeni for the journey to the Hittite country.”<sup>191</sup> Such use of valuable metals as currency was widespread in the ancient world. This use of copper is similar to the use of ‘loose tin’ carried by Assyrian merchants in Anatolia described by Veenhof in the 19th-century B.C. Kanish tablets, as well as references to the use of specific weights of tin and bronze (as well as the more common ‘currencies’ of silver and gold) as payment for goods at Ugarit.<sup>192</sup> Contemporary weight sets and scrap hoards such as the finds of scrap jewelry on the Uluburun wreck and scrap metal hoards on many Bronze Age sites also show the importance of the use of weights of metal as currency.<sup>193</sup> Near Eastern cultures typically measured the value of goods in

<sup>190</sup> Wiseman 1953, 105. The talents in this text (“*kakuru*”) weigh 1,800 shekels, half of the weight of the Old Babylonian talent, according to Wiseman (1953, 105).

<sup>191</sup> Wiseman 1953, 14, 105.

<sup>192</sup> Veenhof 1972, 30, 80, 257; Heltzer 1977, 204-7.

<sup>193</sup> Petruso 1978; 1984; 1992; Bisson de la Roque 1950, Pl. III, V-XXXVIII; Veenhof 1972, 30, 80, 257; Muhly 1979, 96; Knapp et al. 1988, 149-50, 154-5, 169-71; Pulak 2001, 24-5, 45.

terms of shekels of gold, or, more often, silver, which was a standard of exchange throughout much of the Near East.<sup>194</sup>

### 3) Ugarit

Production of copper and bronze objects was also well organized in contemporary Ugarit, on the coast of Syria. Ugarit was a major port and trade center in the second millennium B.C. until its final destruction c. 1200 B.C.<sup>195</sup> In 14th- and 13th-century B.C. economic texts from the palace archives, bronze smiths are listed as “royal dependents”, a category which also includes military personnel and other artisans.<sup>196</sup> Documents include inventories of the “tribute of the smiths”, in which each smith is recorded as delivering from 500 to 2000 shekels (approximately 4.7 to 18.6 kg) of metal, perhaps to be paid to the palace or the Hittites as tribute, as well as amounts of copper and tin delivered to smiths in several different villages.<sup>197</sup> This seems to indicate the supply of metal was centrally controlled but the production of metal objects was divided between several different settlements where the actual production of finished copper and bronze items took place, perhaps to be delivered back to the palace upon completion.<sup>198</sup> Copper smiths seem to have lived in at least nine different villages under control of Ugarit according to these texts, although it may be that only a fraction of the total number of craftsmen employed at Ugarit are mentioned in the

<sup>194</sup> Moorey 1994, 236-7; Muhly 1980, 32, 38-9.

<sup>195</sup> Curtis 1985, 37, 47-8.

<sup>196</sup> Heltzer 1982, 25; Curtis 1985, 37, 47-8.

<sup>197</sup> Heltzer 1982, 91, 93-4, 100. The weight calculation is based on a shekel of c. 9.3 g, the ‘Syrian’ standard in use in Late Bronze Age Ugarit (Petruso 1984, 296, 302-3; cf. Pulak 1997, 248; 2000b, 259, 261).

<sup>198</sup> For example, PRU, II, 137: “(One) hundred (shekels) of copper... (debited) against the smiths of (the village of) *Kttglm*./ forty (shekels) of copper, (debited) against the smiths of (the village of) *Art*./ 500 (shekels) of copper, (debited) against *Mtn*, man of (the village of) *Ris*” (Heltzer 1982, 94, 100).

texts.<sup>199</sup> Metalworkers are the most numerous artisans mentioned in the surviving texts, however.<sup>200</sup> According to M. Heltzer, artisans, including smiths, may have been organized under either elected or appointed elders “who were, to a certain extent, responsible for the execution of the work, as well as for the quantity of raw materials which the artisans received.”<sup>201</sup>

Like the Mycenaean palaces, Ugarit had a highly developed palace economy, with a probable state monopoly on agriculture and craft production throughout the region it controlled; much if not all foreign trade was likely run through the palace as well.<sup>202</sup> Ugarit’s foreign trade was conducted through *tamkāru*, or royal trade agents, who were subordinate to the palace but also may have exercised some degree of commercial independence. Often texts of the Late Bronze Age Near East use the Akkadian terms *tamkāru* and *mār šipri* (“messenger” and “ambassador”, respectively) interchangeably, indicating the close relationship between foreign trade and international diplomacy.<sup>203</sup> *Tamkāru*, at least in the Syrian city of Nuzi, however, may have been more closely associated with overland trade than *mār šipri*, who supervised shipment of specific commodities for the palace, such as wool, copper, and cattle; *tamkāru* were low-level palace officials who conducted royal trade as well as business activities on behalf of other elites “who take the opportunity of the merchant’s journeys to entrust him with their own capital with a view to commercial profits”.<sup>204</sup> Several texts from Ugarit mention transactions by private traders. The most prominent

<sup>199</sup> Heltzer 1982, 94, 98.

<sup>200</sup> Heltzer 1982, 99.

<sup>201</sup> Heltzer 1982, 99.

<sup>202</sup> Heltzer 1982, 101-2, 186-7.

<sup>203</sup> Zaccagnini 1977, 171-2. For *tamkārū* in Mesopotamia during the Old Babylonian period, see Leemans 1950; Larsen 1976 220-1, 231-6, 264-5.

<sup>204</sup> Zaccagnini 1977, 172, 174, 178, 180-1.

being Sinaranu, a 13th-century B.C. merchant who seems to have had a franchise to trade with Crete and had his private cargo exempted from taxes; he was even exempt from serving as a messenger to the king of Ugarit, a service which was apparently usual for foreign traders.<sup>205</sup> The Uluburun ship's final voyage may have operated in this way as well; Pulak (1997) proposes that the Uluburun ship's cargo was

probably placed in the care of an official or a semi-official who represented the king's interest, but who may have engaged in some private trade of his own on the side. This emissary also was entrusted with a contingent of prestige goods that he would present personally to the royalty receiving the cargo.<sup>206</sup>

This interpretation fits well with the cargo of the Uluburun ship. Its primary cargo of ingots of copper, tin, and glass, jars of terebinth resin and objects of precious materials (gold, silver, ivory, ebony, and precious stones) were likely goods for exchange between royalty, while other items, including a Canaanite jar full of faience beads and four pithoi full of Cypriot pottery, lamps, and 'wall brackets', more likely represent goods intended for private exchanges.<sup>207</sup> S. Sherratt notes that the Cypriot pottery in particular "represents a class of goods which is absent from the documentary, literary, and iconographical record of the second millennium and which played no part whatsoever in high elite culture;" these items may have instead been "exchanged at an altogether different level, by a form of direct, decentralised, and essentially commercial trade, aimed at a sub-élite market whose access to the real determinants of power was limited."<sup>208</sup> The reason certain types of pottery were excluded from elite trade, according to Sherratt, may have had to do with the power and prestige

<sup>205</sup> Peltenburg 1991, 169; Zaccagnini 1977, 175, 180-3; Linder 1981, 34-5; Bachhuber 2006, 351.

<sup>206</sup> Pulak 1997, 256.

<sup>207</sup> Bass 1989, 1-2, 4-8; Pulak 1998, 193-207; Wachsmann 1998, 307; Sherratt 2000, 83. Similar goods are found on many land sites as well, too many to be exhaustively listed here. For Cypriot pottery in Egypt, see Merrillees 1968. For imported Canaanite jars in Egypt, see Bourriau et al. 2001. For examples of Late Cypriot and other exports to some Levantine sites, see Artzy 2006, 50-60.

<sup>208</sup> Sherratt 1994, 65-8; 2000, 83.

associated with some materials and objects. Elites would want to control access to certain types of objects and rare materials in order to reinforce their status in society; similarly, lower-status individuals in many cases would want accessible status symbols of their own. Imported pottery may have become a status symbol for lower classes such as palace dependents: “From the point of view of the real élites, pottery in itself was a ‘safe’ good, something which could be traded freely and directly to sub-élite consumers without risk.”<sup>209</sup> This theory may explain the assemblage from the Point Iria shipwreck, wrecked off the coast of Greece around 1200 B.C. as well. The cargo recovered from the wreck was almost entirely pottery, equally divided between Cypriot, Minoan, and Mycenaean types; although the vessel’s origin is unclear, the assemblage from the site probably represents part of the cargo of a small trading vessel traveling between Cyprus, Crete, and mainland Greece.<sup>210</sup>

Over 350 different trade items are listed in economic texts from Ugarit, the most prominent being copper and bronze utensils, textiles, grain, and oil, as well as various luxury goods.<sup>211</sup> References to large amounts of copper are common in these texts; a comparison of copper prices in Ugarit and other Near Eastern centers indicate that copper was fairly cheap in Ugarit and Nuzi in relation to its price in other major cities, probably due to large-scale importation of the metal.<sup>212</sup> Since Ugarit was a major maritime center situated on a major trade route and in close proximity to Cyprus, much of this copper was likely transported by sea from Cyprus.<sup>213</sup> Several Ugaritic texts contain requests for copper or specific references to copper as part of a ship’s

<sup>209</sup> Sherratt 2000, 83.

<sup>210</sup> Lolos 1999, 43; Agouridis 1999, 27; Vichos 1999, 79; Day 1999, 68.

<sup>211</sup> Linder 1981, 36.

<sup>212</sup> Heltzer 1977, 205-6.

<sup>213</sup> Heltzer 1977, 208-11.

cargo.<sup>214</sup> In one letter (KTU 2.39), a vassal requests copper from the ruler of Ugarit: “The enemy is over us [... and] there is no copper [...] purify copper,... search [for it], wherever you can get it and send it to me.”<sup>215</sup> Another text (KTU 4.390) includes a talent of copper as well as bronze tools in a list of cargo in a ship from Alashia.<sup>216</sup> A third text (KTU 4.394) reports the loss at sea of a cargo of copper: “... hundred ten/twenty... copper is lost on a ship... 20 for the people from *Umd.* / 10 for Kutilana.”<sup>217</sup>

Exports from Ugarit to Alashia include grain and oil, which, like copper, were likely controlled by a royal monopoly.<sup>218</sup> Linder (1981, 37) proposes that these commodities may have been the main trade items used by Ugarit to pay for its copper imports from Alashia. Other texts mention trade agents and ships owned or controlled by the king of Ugarit operating in Alashia and other areas, supporting the theory that this trade was closely supervised by the palace, and, like the interactions in the Amarna tablets, had an important diplomatic function.<sup>219</sup> Once copper was received in Ugarit, the city probably served as a redistribution center of copper to other regions; for example, one Ugaritic text mentions a “merchant from Beirut” who traveled to the city to purchase copper, probably by ship.<sup>220</sup> Surviving Ugaritic texts refer to foreigners residing within the domains of Ugarit, particularly around its harbor; some of these individuals were likely Cypriots or connected with Cypriot trade.<sup>221</sup> Some of these foreigners had

---

<sup>214</sup> Linder 1981, 37.

<sup>215</sup> Hoftijzer and van Soldt 1998, 334.

<sup>216</sup> Hoftijzer and van Soldt 1998, 339.

<sup>217</sup> Hoftijzer and van Soldt 1998, 339.

<sup>218</sup> Linder 1981, 33.

<sup>219</sup> Linder 1981, 33-4.

<sup>220</sup> Linder 1981, 37.

<sup>221</sup> Astour 1970, 121; Sasson 1966, 135.



special privileges appropriate for diplomatic envoys, including gifts of food and, in one case, access to a ship.<sup>222</sup>

Overall, the textual evidence from Ugarit indicates that it was a major importer of copper, and may have served as a redistributor of the metal to other regions as well, including the Aegean.<sup>223</sup> This trade likely took place on several levels. Judging from the textual evidence from Ugarit, the Cape Gelidonya ship's copper cargo seems to be fairly typical of vessels involved in the import of copper to Ugarit, a similarity noted by Linder (1972).<sup>224</sup> The relatively small amount of copper listed in KTU 4.390 shows that not all copper shipments were as large or rich as the Uluburun cargo. Such cargoes may have been intended for several individuals or perhaps groups (for example, KTU 4.394, which refers to a shipment for "the people of *Umd*"); at least two and perhaps four parties are mentioned as being the intended recipients of this vessel's copper cargo.<sup>225</sup> This may be relevant to the incised secondary marks found on many oxhide ingots, which could have served as owners' marks (see Chapter III).

Ugarit may have played multiple roles in the copper trade, possibly including the production of at least some oxhide ingots using imported ore or partially refined metal. A limestone oxhide ingot mold was discovered at the coastal site of Ras Ibn Hani, one of Ugarit's ports.<sup>226</sup> The site is located only 4.5 km from Ugarit/Ras Shamra, and exhibits palace architecture at the site very similar to that found at Ugarit.<sup>227</sup> Craft production occurred in a large complex called the 'North Palace' by excavators; these

<sup>222</sup> Sasson 1966, 135.

<sup>223</sup> Linder 1981, 37.

<sup>224</sup> Linder 1972, 163-4.

<sup>225</sup> Hoftijzer and van Soldt 1998, 339.

<sup>226</sup> Lagarce et al. 1983, 277, Fig. 15.

<sup>227</sup> Lagarce 1986, 85.

activities included metallurgy, as finds of crucible and tuyere fragments, part of a pot bellows, spilled copper and lead on the floors in the workshop area, and lead ingots as well as the oxhide ingot mold show.<sup>228</sup> These finds are dated to the 13th century B.C.<sup>229</sup>

The presence of these metallurgical installations in a 'palace' or important structure in the settlement parallels similar finds in Cyprus, particularly at Enkomi and Kition, and has been interpreted by some as resulting from a connection between copper metallurgy and religious practices in Late Bronze Age Cyprus and elsewhere.<sup>230</sup>

Although Ugarit lacked major local copper sources, Ras Ibn Hani is located only about 100 km away from Cyprus, which could have supplied copper in some form (possibly in the form of matte or 'furnace conglomerate', similar to material found among metallurgical remains at Kition and other Late Cypriot sites) to fuel a local metallurgical industry, perhaps with some involvement by Cypriot smiths.<sup>231</sup> A few oxhide ingot fragments have also been found at Ugarit.<sup>232</sup> Other copper sources as the Feinan region of southern Jordan could have also played a role. However, in comparison to contemporary Cypriot towns such as Enkomi and Kition, there is very little evidence for metallurgy at Ugarit.<sup>233</sup> The presence of the stone mold could have been influenced by contacts with Cyprus, much as the trade between Egypt and Byblos earlier in the Bronze Age seems to have inspired the adoption of foreign

<sup>228</sup> Lagarce 1986, 88-90.

<sup>229</sup> Muhly 1985b, 36.

<sup>230</sup> Lagarce and Lagarce 1996, 2; Karageorghis and Demas 1985, 93-102, 240, 242, 253-4; Knapp 1986, 1-3, 7-24, 43-56.

<sup>231</sup> Lagarce 1986, 85; Karageorghis and Demas 1985, 398, Pl. B; Muhly 1989, 302. Exchanges of craft specialists occur in the Amarna letters (e.g., EA 49); perhaps Cypriot metalworkers were exchanged with foreign rulers as well (Moran 1992, 120-1).

<sup>232</sup> Muhly 1985b, 46.

<sup>233</sup> Muhly 1973a, 194-6, 214.

artistic styles, customs, and religious influences in both cultures.<sup>234</sup> By the 13th century B.C., the oxhide ingot was internationally recognized, although there is no evidence for a Cypriot origin of the oxhide ingot shape. In fact, the earliest examples of oxhide ingots come from Crete, while the earliest representations are from Egypt, both areas which were likely importing such ingots rather than producing them locally.<sup>235</sup> The fact that no stone oxhide ingot molds have been found on Cyprus may indicate that stone molds were *not* commonly used in the production of oxhide ingots.

The sources of the copper used by the city-states of Alalakh and Ugarit remain unknown.<sup>236</sup> Cyprus could have supplied Ugarit and perhaps also the Mycenaean palaces with copper either directly or indirectly. Substantial trade connections between these regions existed in the period c. 1400-1200 B.C., as shown by Cypriot pottery in the Aegean, Egypt, and Syro-Palestinian cities such as Ugarit, as well as Mycenaean and Minoan pottery in Cypriot sites, particularly along the island's south coast.<sup>237</sup> Texts from Mari and Babylon indicate that copper from Alashia was imported to these areas as well during the 18th century B.C.<sup>238</sup> Recent chemical analyses of Cypriot objects from this period indicate that tin had begun to be used on Cyprus at this time;

<sup>234</sup> Redford 1992, 38-43; Wachsmann 1998, 10-1. A silver bowl with an Ugaritic inscription is known from Hala Sultan Tekke (Karageorghis 2002, 108). The presence of Mycenaean pottery throughout Syria and Cyprus in the Late Bronze Age indicate the extensive trade links between the two regions (Muhly 1973a, 195).

<sup>235</sup> Muhly 1985b, 35; Bass 1967, 62-7; Muhly et al. 1988, 281, 283-5, 290-1. Muhly's (1985b, 35) statement that "no argument can be made for a connection between ox-hide ingots and Cypriot copper" has since been disproved by lead isotope analysis of oxhide ingots and ingot fragments. Objections on stylistic grounds are still valid, however; most oxhide ingots with established Cypriot sources seem to date from the 14th to 11th centuries B.C., while Minoan examples and some Egyptian representations are 100-200 years older (Bass 1967, 62-7; cf. Muhly et al. 1988, 290-1).

<sup>236</sup> Wiseman 1953, 14; Muhly 1973a, 208-9.

<sup>237</sup> Cline 1994b, 31-67; Muhly 1982, 254; Muhly 1985b, 23-5, 27-31.

<sup>238</sup> Georgiou 1979, 86.

as there are no tin deposits on the island, it must have been imported, perhaps from Mari and points east.<sup>239</sup>

Other sources are possible, however. Recent research on copper alloy objects from the Early and Middle Helladic Aegean indicates that a combination of sources were used.<sup>240</sup> The Cyclades' small metal deposits played an important role in the Early and Middle Bronze Age, while the role of Laurion in southern Greece as a copper source in the Bronze Age is debated but probably very significant; other copper sources are known on mainland Greece (though evidence of their exploitation in the Bronze Age has not been established).<sup>241</sup> The roles of these deposits seemed to have changed over time; Stos-Gale and Gale (1983) propose a shift in the MM III/ LM IA period from reliance on Cycladic sources to Laurion; while no evidence for Bronze Age metallurgical production has survived at Laurion, the nearby settlement of Thorikos was inhabited throughout the Bronze Age.<sup>242</sup> Anatolia was also a potentially rich source of copper and tin in the Bronze Age; the region has abundant metal resources and was a major center in the development of early metallurgical technology.<sup>243</sup> Evidence for the exploitation of local copper and tin sources in the region has been dated to as early as the fourth and third millennium B.C.<sup>244</sup> However, evidence for exports from Anatolia to the Aegean and Cyprus during the second millennium B.C. is

<sup>239</sup> Gale et al. 1996, 373.

<sup>240</sup> Stos-Gale 2000, 63-6. According to Stos-Gale, 30% of the copper alloy objects analyzed originated from Cyprus, 60% from Laurion, and 10% from unidentified, non-Aegean, non-Cypriot sources.

<sup>241</sup> Gale 1999, 118; McGeehan Liritzis 1996, 115-7, 130; Stos-Gale 1998, 718-20; Gale and Stos-Gale 1999, 273.

<sup>242</sup> Stos-Gale and Gale 1983, 61-3. See Bachhuber (2003, 18-24) for a detailed discussion of the research into the sources of Aegean copper.

<sup>243</sup> Yener 2000, 17. For more detailed summaries of archaeological evidence for early Anatolian metallurgy, see Yener 2000, 17-70; Muhly 1973a, 199-208; 1985a, 129-31; 1985c; 1999; Yener and Vandiver 1993; Piggott 1999.

<sup>244</sup> Yener 2000, 1-2, 4, 12.

slim.<sup>245</sup> Cline reports only twelve Anatolian objects known from Late Bronze Age Aegean sites, a far lower number than objects with Syro-Palestinian, Egyptian, Cypriot, or even Mesopotamian origins.<sup>246</sup> Mycenaean and Cypriot objects are generally less scarce in LBA contexts in coastal and southern Anatolia; pottery finds indicate that there may have been Minoan (MM I-II) settlers on the Anatolian mainland at Miletus, and later a Mycenaean presence during the LHIIIA period at Rhodes, Iasos, Miletus, Ephesus, Müskebi, and possibly other coastal sites.<sup>247</sup> Mycenaean tombs at Müskebi and Miletus indicate probable Mycenaean communities at these locations.<sup>248</sup> In southern Anatolia, Cypriot and Mycenaean pottery is known from Mersin, and Cypriot pottery was found at Tarsus.<sup>249</sup> An oxhide ingot fragment is also known from the Hittite capital of Hattusas (Boğazköy), indicating at least an indirect connection to a larger eastern Mediterranean copper-trading network; since contacts between Anatolia and the Near East were much more common in this period, oxhide ingots could have reached Hattusas via Ugarit or some other coastal city.<sup>250</sup> The direct export of Anatolian copper to the Aegean is therefore unlikely in the absence of other evidence for trade, though some contact certainly existed. It has been suggested that Anatolia provided “invisible exports” for the Aegean such as timber, slaves, horses, metals, or other goods difficult to trace in the archaeological record.<sup>251</sup> The west coast of Anatolia is considered to be part of the Hittite empire, but may have been under indirect Hittite control at best; tablets from the Hittite capital of Hattusas detail political unrest and warfare in the western part of the empire, caused in part by

<sup>245</sup> Muhly 1985b, 29.

<sup>246</sup> Cline 1994b, xvi.

<sup>247</sup> Mee 1998, 137-41; Dietz 1984; Gödecken 1988; Niemeier 1988; 1999, 27-41.

<sup>248</sup> Mee 1998, 141.

<sup>249</sup> Garstang 1953, 242-3; Goldman 1956, 104, 112, 164, 204-5.

<sup>250</sup> Macqueen 1986, 97; Güterbock and Mellink 1983, 139-40; Buchholz 1988, 194.

<sup>251</sup> Mee 1998, 141.

men from ‘Ahhiyawa’, sometimes identified by scholars as Mycenaeans.<sup>252</sup> Such unrest may have even resulted in an embargo on the Aegean by the Hittite Empire, according to some scholars.<sup>253</sup>

Anatolian contacts with Ugarit were more substantial; the city fell under the indirect control of the Hittite Empire from the 14th century B.C. onwards, and paid tribute to the Hittite capital.<sup>254</sup> Other economic ties seem to have existed as well; for example, the “merchants of Ura” in Cilicia are a prominent group of foreign sea-traders in Ugaritic economic texts; these traders were permitted to live and trade in the city during the summer.<sup>255</sup> Hittite seal impressions also occur in Ugaritic documents, indicating the presence of high-ranking Hittites in the city from the early 14th century B.C. until its destruction c. 1200 B.C.<sup>256</sup> Anatolian pottery and other artifacts also occurs at the Late Bronze Age sites of Tell Abu Hawam and Tell Nami.<sup>257</sup> Occasional Hittite artifacts arrived in Cyprus through contact with Ugarit, although Hittite influence over the Cypriots seems to have been limited at best.<sup>258</sup> The documentary record from Ugarit, however, seems to indicate that a large part of the state’s copper resources were imported from Alashia/Cyprus rather than Anatolia; substantial copper sources were available in Syria, Transjordan, and the Sinai which may have been exploited as well.<sup>259</sup>

<sup>252</sup> Güterbock 1997a; 1997b; Wachsmann 1998, 128-30; Kolb 2004, 587-8.

<sup>253</sup> See Bachhuber (2006, 355-6) for references.

<sup>254</sup> Astour 1981, 20-1.

<sup>255</sup> Linder 1981, 35-6.

<sup>256</sup> Astour 1981, 19-21, 29; Porada 1981, 47.

<sup>257</sup> Artzy 2006, 51, 55, 57.

<sup>258</sup> Karageorghis 2002, 34; Kolb 2004, 588.

<sup>259</sup> Muhly 1973a, 208-17; Forbes 1964, 9:11-2; Rothenberg 1978, 7, 28-9; 1990, 1-54; Hauptmann et al. 1989, 6-10; Levy et al. 2002.

*Textual Evidence for Trade in Metals in Anatolia and the Near East*

Texts dating to the late third and second millennium B.C. record a well-organized trade in tin in the Near East and Anatolia. While tin was a scarcer commodity than copper and was needed in smaller amounts to supply a tin-bronze industry, these texts show that Bronze-Age societies developed sophisticated trade networks to transport large amounts of metal over long distances. Evidence for overseas import of copper into Mesopotamia, while geographically and chronologically separated from the main period under discussion (the Late Bronze Age), also have some use as examples of how the copper trade worked in a Bronze-Age society.

Texts from the palace of Zimri-lin (c.1780-1760 B.C.) of Mari in northern Syria attest to a thriving trade in tin operated by Assyrian merchants, who exported tin to Anatolia for twice the price at which they had purchased it.<sup>260</sup> These records indicate that copper and bronze were imported to Mari from Alashia, and that tin was imported to Mari from the Mesopotamian city of Eshnunna; it was then transported to various cities in Syria and Palestine, ultimately reaching Ugarit.<sup>261</sup> The source of the tin from Mari is unknown, but it may have been transported overland from eastern Afghanistan.<sup>262</sup> One document records the purchase of tin by individuals called “the Caphtorite” (usually translated as ‘the Cretan’), who received 20 minas of tin “for the second time,” and “the Carian,” who received an unknown amount of tin.<sup>263</sup> The foreigners in Mari were likely agents for purchasing tin and other goods in the city.<sup>264</sup> Various objects from “Kaptara”, usually identified as Keftiu or Crete, are mentioned in the

<sup>260</sup> Muhly 1973a, 292; Strange 1980, 91.

<sup>261</sup> Muhly 1973a, 293; Georgiou 1979, 86.

<sup>262</sup> Muhly 1973a, 292; Leemans 1960, 138.

<sup>263</sup> Strange 1980, 90; Malamat 1971, 34.

<sup>264</sup> Strange 1980, 91.

Mari texts as well; therefore, it seems likely that the tin route continued further west to Crete and Anatolia.<sup>265</sup> References to objects and materials connected with Caphtor or Keftiu are also known from several Bronze-Age texts from Mari. Since references to metal objects of ‘Keftian’ origin, workmanship, or style are the most prominent associations with the name, Keftiu seems to have been known especially for its metalwork.<sup>266</sup> Scattered references to the name Keftiu appear in New Kingdom Egyptian texts as well, dating from perhaps as early as c. 2300 B.C., through the second and first millennia B.C., to the most recent references in the Roman period.<sup>267</sup> Keftiu is most commonly identified with Crete, although locations such as Cyprus, Cilicia, and the Cyclades have also been proposed.<sup>268</sup> The sophisticated Minoan metallurgy industry would have required large amounts of imported tin and copper in order to function, since there are no tin and only insignificant copper deposits known on the island.<sup>269</sup>

Other records of long-distance trade of metals, primarily tin, have been excavated from the site of Kültepe (ancient Kaniš or Kanish) in central Anatolia. Kaniš contained a community of Assyrian merchants and caravan personnel who lived in a trading colony alongside local Anatolians.<sup>270</sup> Over 10,000 tablets have been discovered on the site, although only a fraction of these have been published.<sup>271</sup> These tablets document the importation by Assyrian merchants of large amounts of tin and textiles during the 19th century B.C.; a total of 25,000 minas of tin, or approximately twelve tons, is

<sup>265</sup> Muhly 1973a, 293-4; Leemans 1960, 138; Strange 1980, 91-2.

<sup>266</sup> Strange 1980, 91-3, 96; Wiener 1990, 146.

<sup>267</sup> Strange 1980, 108-9.

<sup>268</sup> Strange 1980, 113-84.

<sup>269</sup> Branigan 1968, 51-2, 57; 1974, 57-65, 105-6; Wiener 1990, 146.

<sup>270</sup> Veenhof 1977, 110-1, 113; Larsen 1976, 50-1.

<sup>271</sup> Larsen 1976, 50-1; Derckson 1996, 1.



documented in published texts.<sup>272</sup> McKerrell estimates that Anatolia imported about one ton of tin annually for bronze production during this period, while M. Larsen estimates from the same texts that about 13,500 kg, or about 200 donkey-loads/80 tons, was exported from Assur to Kaniš over the course of fifty years.<sup>273</sup>

Assyrian merchants were also involved in some copper trading, though the metal was probably traded only locally and is not known to have been exported out of Anatolia; the town may have been off the main copper trade route, which likely led to several local sources of copper as well as the Ergani Maden copper deposits in southeastern Turkey.<sup>274</sup> Both copper and tin traded at Kanish was probably redistributed to other settlements across central Anatolia along with other goods, particularly textiles.<sup>275</sup> Derckson ascribes the regional nature of the copper trade to the “high price and transport costs, which made export to Mesopotamia unprofitable.”<sup>276</sup> While the trade was overland and generally involved smaller quantities than maritime trade, occasionally very large amounts of copper were traded; one text mentions a transaction involving 195 talents of copper, while another pertains to 10,000 minas (c. 5,000 kg) of copper promised by “the general” to a merchant.<sup>277</sup> Metals, particularly silver and gold but also at times copper and tin, were used as currency at Kanish; only

<sup>272</sup> Veenhof 1972, XXI, 79; Larsen 1976, 91; McKerrell 1978, 21; Derckson 1996.

<sup>273</sup> McKerrell 1978, 21; Larsen 1976, 90; Muhly 1980, 33. A “donkey load” is considered by Derckson (1996, 61) to be between 60-90 kg; Veenhof states that a “donkey load” in the same texts is about 180-190 minas in all, or “at least some 90 kilos” (Veenhof 1972, 45).

<sup>274</sup> Larsen 1976, 86, 91-2.

<sup>275</sup> Larsen 1976, 52. Based on published texts, the ratio of donkey loads of textiles to loads of tin was 3:1, though tin was generally about five times as valuable as the textiles imported (Larsen 1976, 89-90).

<sup>276</sup> Derckson 1996, 181.

<sup>277</sup> Derckson 1996, 183-4. For amounts of copper involved in transactions in translated texts from Kanish, see Derckson 1996, 184-208.

the tin seems to have been imported over long distances, while the other metals were likely obtained from local Anatolian sources.<sup>278</sup>

The texts from Kanish come from archives in private residences; merchant families imported goods from Assyria to the settlement. Muhly *et. al.* (1988, 288-9) cite these archives as evidence of the probable dominance of private trade in the Late Bronze Age, although the local palaces as well as the palace at Assur were indirectly involved (treaties with foreign states, taxes, regulations on exports, the establishment of weight standards, etc). Assyrian merchants were subject to regulation by the palace at Assur as well as the *kārum* (from an Akkadian word meaning “harbor”), a legal organization of the Assyrian trading community at Kanish.<sup>279</sup> This evidence of trade for profit by private individuals and families rather than rulers or palace elites does not necessarily imply that this was the norm for the entire Near East and eastern Mediterranean in this period.<sup>280</sup> The Uluburun ship carried about one ton of tin, or the entire annual amount entering Kaniš according to McKerrell’s estimate, as well as ten tons of copper and other cargo.<sup>281</sup> In other words, a single vessel the size of the Uluburun ship could deliver in one voyage an amount of metal at least ten times that which Assyrian merchants transported to Kanish in an entire year. It seems likely that once seafaring technology was advanced enough, transport of metal cargoes by sea would have been preferred to land travel whenever possible. The mountainous topography of Asia Minor probably resulted in a more land-based trade in metals in Anatolia than in other regions of the Mediterranean with more direct access to the sea.

<sup>278</sup> Derckson 1996, 47, 165, 181; Veenhof 1972, 31-2, 244-6.

<sup>279</sup> Derckson 1996, 169.

<sup>280</sup> Larsen 1976, 93-105; Veenhof 1972, 129, 305-6.

<sup>281</sup> Pulak 1998, 199.

*Mesopotamian Texts and Iconographic Evidence*

Cuneiform texts from the Late Uruk/Jemdet Nasr Period to the Old Babylonian Period (c. 3100-1750 B.C.) record the importation by sea of copper from Meluhha (probably northwest India), Magan (likely southeastern Arabia), and Dilmun (probably modern Bahrain) by Mesopotamian merchants, probably working either as agents for the city temple or rulers.<sup>282</sup> Some trade by private individuals took place as well, though on a smaller scale.<sup>283</sup> The archives of one merchant from Old Babylonian period Ur were excavated by Woolley; these record the importation of copper from Tilmun (probably in Iran) via the Persian Gulf, as well as various disputes with customers over the quality of his copper and the speed of his deliveries.<sup>284</sup> Production of finished copper and bronze products seems to have followed a similar pattern as Pylos, Alalakh, and Ugarit in Third Dynasty Ur (c. 2100 B.C.); at all of these sites, clay tablets record the allotment of copper to smiths for the production of weapons and other items.<sup>285</sup>

The archaeological record of Bronze Age copper production in Oman supplements the textual evidence for the maritime trade in copper through the Persian Gulf. Bronze-Age smelting sites dating to the third millennium B.C. are known in several localities; slag heaps on these sites are estimated at up to four thousand tons, perhaps representing the production of two to four thousand tons of copper.<sup>286</sup> The peak of early copper production in this region occurred in the late third millennium B.C.<sup>287</sup> ‘Plano-convex’ or bun ingots were manufactured and exported; a few have been

---

<sup>282</sup> Weeks 2003, 14-5; Leemans 1960, 5, 11, 19, 21, 34, 50-1, 54; Larsen 1976, 227-8.

<sup>283</sup> Leemans 1960, 50, 56.

<sup>284</sup> Muhly 1980, 38.

<sup>285</sup> Wiseman 1953, 2, 105-6; Ventris and Chadwick 1973, 352.

<sup>286</sup> Edens and Kohl 1993, 25; Hauptmann et al. 1988, 35.

<sup>287</sup> Edens and Kohl 1993, 25.

discovered in caches in Oman, Anatolia, and elsewhere.<sup>288</sup> A copper-producing complex from this period is known at Maysar 1. In one part of the settlement metallurgical finds were common, such as copper ore, slag, furnace fragments, and pieces of matte. Additionally, the site contained large numbers of copper artifacts, particularly from the Umm al-Nar Period (c. 2500-1900 B.C.), when, based on survey evidence of slag remains, Bronze Age copper production in the region appears to have been at its peak; copper production continued into the second millennium B.C. at some level, as shown by copper-based artifacts in tombs.<sup>289</sup> Unfortunately, very little evidence of metallurgical production is known between the third millennium and Islamic period in Oman.<sup>290</sup>

However, Leemans (1960) states that “We have no right to infer that the manner of trading was consistent throughout any one of the periods” based on the fragmentary textual evidence of the copper importation during the Old Babylonian period, a statement that can also apply to the copper trade in the Mediterranean during the second millennium B.C.<sup>291</sup> Moorey (1994, 246-7) notes that Mesopotamia obtained metals from a variety of sources, which varied depending on the politics and other conditions of the times; sources of metals were typically known only in general (and often incorrect) terms.<sup>292</sup> Ancient textual sources on the trade in copper and other metals are useful mainly as examples of how the trade worked in specific cases in specific Bronze Age societies, which, in turn, can be used to infer the general nature of the trade mechanisms used in interregional trade in the Bronze Age Mediterranean and

<sup>288</sup> Weeks 2003, 37, 47; Weisgerber 1983, 270-1, 275; Müller-Karpe 2005, 487, Abb. 3.

<sup>289</sup> Hauptmann et al. 1988, 35-6; Weeks 2003, 24-5.

<sup>290</sup> Weeks 2003, 24-8.

<sup>291</sup> Leemans 1960, 56.

<sup>292</sup> Moorey 1994, 246-7.

Near East. These sources cannot, however, be relied upon to give a complete picture of the trade in this period. Copper and other metals were produced and exchanged through several different mechanisms, including state- or temple-run production and trade/gift exchanges, as well as some private trade. Most scholars agree that centralized control accounted for the majority of the copper trade by the Late Bronze Age.<sup>293</sup> Some evolutionary changes can be expected over time, based on political, economic, and technological factors. Few (if any) private individuals without some connection to the ruling elite were likely to have the capital to conduct long-distance overseas trade in copper during this period. However, the interpretation of the Cape Gelidonya ship's assemblage as the cargo of a 'tramp cargo ship' in the hands of private entrepreneurs suggests that private trade in fairly large amounts of metals could have occurred in the Mediterranean by the 13th century B.C.<sup>294</sup> Kolb points out that the Cape Gelidonya ship could have been in the service of royalty rather than a private individual, however.<sup>295</sup> Forbes and others propose that the first metal smiths were itinerant traders and craftsmen of this sort, dealing with relatively small-scale metal production.<sup>296</sup> This hypothesis likely accounts for most of the metallurgical activity in the Early and Middle Bronze Age Mediterranean, but by the Late Bronze Age more intensive production was occurring as well in several areas.

Besides the Uluburun and Cape Gelidonya cargoes, other known Late Bronze Age shipwreck cargoes are relatively undistinguished. These ship cargoes seem to be indicative of small-scale trade by independent merchants or local or regional elites. A presumed wreck cargo found in the sea off Kyme in Greece (Euboea) consisted of

---

<sup>293</sup> Peltenburg 1991, 169; Muhly et al. 1977, 361.

<sup>294</sup> Muhly et al. 1977, 361.

<sup>295</sup> Kolb 2004, 584.

<sup>296</sup> Forbes 1964, 8:63, 67-8, 91; Dever and Tadmor 1976, 168; Tylecote 1987a, 14.

seventeen complete and two fragmentary oxhide ingots, while a cargo of five tin ingots and a copper oxhide ingot were discovered along with four Bronze Age-style stone anchors near Haifa.<sup>297</sup> At nearby Kefar Samir, eight tin bar-shaped ingots and two plano-convex tin ingots, as well as seven lead ingots were found with five Late Bronze Age anchors and an Egyptian-style sickle sword.<sup>298</sup> A fragment of a lead ingot and fragments of copper oxhide ingots were found with scrap bronze and two stone anchors off the coast of Israel near Ha-Hotrim.<sup>299</sup> The Cape Iria shipwreck, wrecked off southern Greece around c. 1200 B.C., carried Cypriot, Mycenaean, and Minoan pottery, while the vessel which capsized or sank at Şeytan Deresi off the southwestern coast of Turkey around 1600 B.C., also carried a relatively small cargo of pottery of Aegean or Anatolian origin.<sup>300</sup> A Cypriot origin and an intended arrival at a Mycenaean center in Greece or mainland Crete have been proposed for the Cape Iria shipwreck.<sup>301</sup> Both cargoes were probably from small vessels engaged in relatively short-distance trading expeditions; one estimate of the size of the Cape Iria wreck places its length at twelve meters, equivalent in size to the Cape Gelidonya ship, estimated at 11.5-12.5 m long by Pulak.<sup>302</sup> Smaller amounts of copper and other metals were likely carried on trading expeditions as well, perhaps by merchants accompanied by metalworkers. The activities of these metalworkers may have been invisible in the textual record but probably account for at least some of the

<sup>297</sup> Buchholz 1959, 36-7; Galili et al. 1986, 25, 28. Finds of solitary oxhide ingots recovered from the sea are more common than collections of ingots, but are not necessarily indicative of a shipwreck; ingots could have been thrown overboard to lighten a foundering ship (see Wachsmann and Raveh 1984, 174; Galili et al. 1986, 34).

<sup>298</sup> Raban and Galili 1985, 326-9; Misch-Brandl et al. 1985, 9-10.

<sup>299</sup> Wachsmann and Raveh 1984, 169-72.

<sup>300</sup> Bass 1976, 293-303; Margariti 1998; Wachsmann 1998, 205-6; Lolos 1999, 43-7; Agouridis 2002, 27.

<sup>301</sup> Lolos 1999, 48-9; Vichos 1999, 79.

<sup>302</sup> Pulak 1999, 220; Bass 1967, 45, 163. Although Vichos (1999, 83, 98) puts the length of the Uluburun ship at nine meters, in Pulak's study of the cargo and hull remains, he estimates that the ship was about 15 m long (Pulak 1999, 220). For a detailed reconstruction of the Uluburun ship and its lading, see Lin 2003.

metalworking in rural areas of even the advanced societies of the Late Bronze Age eastern Mediterranean. This could also apply to maritime trade and traders.

Surviving Bronze-Age texts involving the production and trade of metals show a conspicuous lack of information on some topics. Linear B and Ugaritic texts demonstrate that the palace tightly controlled the distribution of metal to smiths for the production of copper and bronze objects. This centrally controlled production probably accounts for many of the metal objects produced in these societies. Textual evidence for the importation of raw materials, usually in large amounts, also seems to show central control over much if not all of the maritime metals trade in the eastern Mediterranean. However, there is an almost complete absence of textual information on the organization of mining and smelting activities. Copper is described as originating in a ‘mine’ or from a ‘mountain’ in a few cases, but there are no references to how the ore was mined or smelted or how the workers involved were organized. There were doubtless professional mining and metallurgy experts; in the Amarna letter EA 10, in which Burra Buriyaš complains about the quality of gold he received from the pharaoh, he asks if the gold was “[ev]er identifi[ed]” as gold, presumably by a professional assayer or metallurgist.<sup>303</sup> Professional miners and assayers are known from other Egyptian sources, such as inscriptions listing the personnel involved in mining expeditions to the Eastern Desert and Sinai.<sup>304</sup> These professionals may have been few in number in comparison to the total number of workers involved in metal production; the labor intensive processes involved in metal production-- for example, the mining and crushing of ore, charcoal production, and the roasting and smelting of ore-- would require large amounts of heavy labor that could be performed by part-

---

<sup>303</sup> EA 10: 8-24.

<sup>304</sup> Shaw 1998, 246-7.

time, unskilled workers. Diodorus' account of first-century B.C. gold mines in Egypt mentions the use of women, children, and old men for many of these menial tasks.<sup>305</sup>

One of the fundamental questions about copper production in Cyprus and other regions during the Bronze Age is the degree of centralization and labor organization involved: did Bronze Age copper mining and production more closely resemble the mining activities of the Romans at major ore deposits such as Rio Tinto in Spain and Soli on Cyprus, which seem to show a great deal of centralized control, or did it more closely resemble the activities of the Egyptians in the Eastern Desert and Sinai, who organized large, occasional expeditions similar to military campaigns? Was this work conducted on a part-time or seasonal basis by the local inhabitants of mining areas, or did a combination of several methods of metal procurement occur? Weeks has recently proposed such a model for Bronze Age copper production in Oman:

The clearest conclusion to be drawn from the archaeological literature on craft production is that “specialized” copper production in southeastern Arabia could have taken a variety of different forms: from small-scale, independent, part-time, or seasonal production by semi-specialists to full-time production with very high output by specialists attached to large political institutions.<sup>306</sup>

Small-scale smelting operations could take advantage of smaller copper deposits, yet could still account for a large amount of metal produced. Most smelting was likely to be part-time; a 13th-century B.C. text indicates that Hittite peasants may have smelted iron seasonally.<sup>307</sup> The local environment would greatly influence the organization of

<sup>305</sup> Meyer 1998, 267, 270.

<sup>306</sup> Weeks 2003, 45.

<sup>307</sup> Gurney 1952, 83-4; Ventris and Chadwick 1973, 352; Knapp 2003, 562, 569-71. The text is a letter from the Hittite king Hattusilis III to a foreign ruler: “As for the good iron which you wrote about to me, good iron is not available in my seal-house in Kizzuwatna. That it is a bad time for producing iron I have written. They will produce good iron, but as of yet they will not have finished. When they have



copper workers; not only the location and amounts of copper ores, but the availability of fuel, water and food sources, and the difficulty of transporting copper and other goods in the area. Large, well-supplied mining expeditions are well-suited to exploit copper ores in the Sinai and Egypt's Eastern Desert, but were perhaps unnecessary in less arid areas such as Cyprus. Organization of mining activities based on kinship or tribal lines, perhaps working in competition with one another, are also likely, especially in early periods of the Bronze Age: this type of labor organization has been proposed for early copper mining and production in the Balkans and the Alps and is known from ethnographic examples.<sup>308</sup> P. Raber has proposed a model for assessing the exploitation of metal ores in a study of the Polis region of western Cyprus. He divides copper production in Cyprus into three levels:

1. "A state organized, large-scale, full-time industry", such as copper mining in Soli on Cyprus and Rio Tinto on southern Spain during the Roman period; these mines used specialists and large amounts of slave labor for full-time work, and an extensive infrastructure was built to support them.<sup>309</sup>

2. "A local, village-based, seasonal industry", a type known from various ethnographic and historical accounts, where production is family- or clan-based, part-time, and on a small scale.<sup>310</sup>

3. "A transitional, mobilized, local industry", where "the mobilization of essentially local industries resulted from either direct interference or incorporation by the state, indirect interference through tribute or levy, or indirect interference through a market system."<sup>311</sup> Raber's examples of such a system are the 11th-century A.D.

---

finished I will send it to you" (Gurney 1952, 83). Gurney interprets this passage as suggesting Hittite peasants smelted iron in the winter, when the agricultural work was finished (1952, 83-4).

<sup>308</sup> Jovanović 1980, 37; Forbes 1964, 8:53, 56, 71; Shennan 1999, 357-59, 362.

<sup>309</sup> Raber 1987, 301.

<sup>310</sup> Raber 1987, 301-2.

<sup>311</sup> Raber 1987, 301-2.

Chinese iron industry and the development of bronze production in the Nigerian kingdom of Benin.<sup>312</sup> In such a system, a local tradition of metallurgical production is exploited by a centralized power to a large extent, but is not absolutely controlled by a central authority or supplied by an extensive infrastructure as the largest Roman mining operations were.<sup>313</sup>

Large-scale, industrial mining and production of the sort seen at the Roman mines of Rio Tinto or in modern mining may not have occurred or even been necessary in the Late Bronze Mediterranean, although by the end of the Bronze Age similar organization may have occurred (perhaps more closely resembling Raber's third model). While Raber's study of the Polis region of western Cyprus found evidence mainly of small-scale, localized production from periods post-dating the Bronze Age, it shows the usefulness of archaeological survey over textual evidence for assessing the actual levels of copper production in Cyprus throughout its history.<sup>314</sup> Other recent surveys have also found evidence for Bronze Age copper production and labor organization.<sup>315</sup> The evolution of the trade in metals in the Bronze Age is also poorly represented in surviving contemporary texts, due both to the fragmentary nature of archaeologically recovered texts and archives and the largely palace-oriented nature of writing and record keeping in this period. Surviving documentary evidence typically concerns only the most highly developed and centrally controlled section of the trade in metals in this period. These sources may give a fairly accurate picture of much of the metals trade in the Late Bronze Age, but may not apply for earlier periods or for

---

<sup>312</sup> Raber 1987, 302.

<sup>313</sup> Raber 1987, 301-2; Forbes 1964, 8:101; 1966, 7:158-62; Davies 1979, 114.

<sup>314</sup> Raber 1987, 308-10.

<sup>315</sup> Knapp 1997; 1999; Swiny 1981; Rupp et al. 1984; Knapp et al. 1998; Given et al. 1999; Knapp et al. 1999a; Knapp et al. 2002; Given and Knapp 2003.

the mechanics of the metals trade in more peripheral areas. The exploitation of metal sources is one of the most important topics in Bronze Age Mediterranean archaeology, but textual evidence is of little use in answering some questions of production and organization. Very little evidence for mining and smelting operations are likely to occur in the textual records of the period, and what references have occurred are frequently vague and uninformative; questions on the range of copper production in the Bronze Age are better answered by the archaeological record.

## CHAPTER III

### THE ARCHAEOLOGICAL CONTEXTS AND PHYSICAL CHARACTERISTICS OF BRONZE AGE METAL INGOTS

A great deal of evidence for the trade in copper and tin during the late third and second millennium B.C. has survived in the archaeological record. Besides finished objects, ingots of copper and other metals have survived from the Bronze Age and, in many cases, evidence of metal production has been identified in the form of slag, furnace remains, and metallurgical equipment. Bronze-Age ingots are particularly useful for the study of metallurgy; they can provide information on the smelting and refining techniques used to produce the metal, as well as evidence for the metal's origin and method of transport. Bronze-Age ingots, particularly the distinctive oxhide ingot, provide important evidence for the organization of Bronze-Age metal production and the extent of ancient metal trade routes in the Mediterranean region during the second millennium B.C.

#### *Oxhide Ingots*

On terrestrial sites, remains of at least 130 oxhide ingots have been discovered; these occur as whole ingots or more often as fragments, which are fairly common in Late Bronze Age founder's hoards in the eastern and central Mediterranean.<sup>316</sup> Some ingots

---

<sup>316</sup> This estimate is by Gale (1991, 200). Since its publication, oxhide ingot fragments have been found at several more sites in Sardinia (LoSchiavo 1998; 2001; 2005, 405; Begemann et al. 2001), as well as a single oxhide ingot fragment from Qantir in the Nile Delta (Pusch 1995; cf. Pulak 2001; Gale and Stos-Gale 1999). Two and a half oxhide ingots were recently recovered from a tributary of the Euphrates in Şanlıurfa Province in southeastern Turkey (see Belli 2004, 31-2 and Sertok and Gülluce 2005). Four

have been found in underwater contexts, either as isolated finds or, less often, in groups; these have been found in the Mediterranean as far west as the coast of southern France, as far east as the coast of Israel, and as far north as Bulgaria.<sup>317</sup> On land, oxhide ingots and ingot fragments are most frequently found on sites in the eastern and central Mediterranean on or near the sea, concentrated primarily in the Aegean, the Levant, and on islands such as Cyprus, Crete, Sicily, Lipari, and Sardinia (see Appendix 1). Oxhide ingots and ingot fragments have also been found on inland sites far from the Mediterranean coast, at Tell-el Abyad (Dūr-Kurigalzu) in Iraq, at Oberwilfligen in Bavaria, and at the Hittite capital of Boğazköy in central Turkey.<sup>318</sup> The find spots of oxhide ingots show a likely connection to well-established, regular trade routes. While other objects and materials traveled long distances during this period, such as amber and lapis lazuli, such low-bulk items would require less complex logistical planning than the transport of metals, timber, or other bulk goods.<sup>319</sup> Transport by sea generally allowed large cargoes to be transported much more quickly and efficiently than travel by land, particularly in the typically mountainous areas surrounding the Mediterranean, so the finds of oxhide ingots on shipwrecks or as isolated underwater finds are not surprising.<sup>320</sup>

---

oxhide ingot fragments were identified in a Late Bronze Age hoard in Bavaria (Primas and Pernicka 1998), and two ingots were found in the sea off the southern coast of France (Domergue and Rico 2002).

<sup>317</sup> Pulak 1997, 234-5; Bass 1967, 57, 61-2; Wachsmann 1998, 208-9, 211.

<sup>318</sup> Buchholz 1988, 194; Brinkman 1987, 35; Primas and Pernicka 1998.

<sup>319</sup> These included grain, textiles, incense such as the terebinth resin found on the Uluburun wreck, and pottery containers, either as trade items themselves (i.e., the Cypriot pottery from Uluburun) or as containers for scented oils, resins, dyes, wine or other liquids (see Knapp 1991, 21, 26-7, 31-3; Pulak 2001, 33, 40-2).

<sup>320</sup> Braudel 1995, 25.

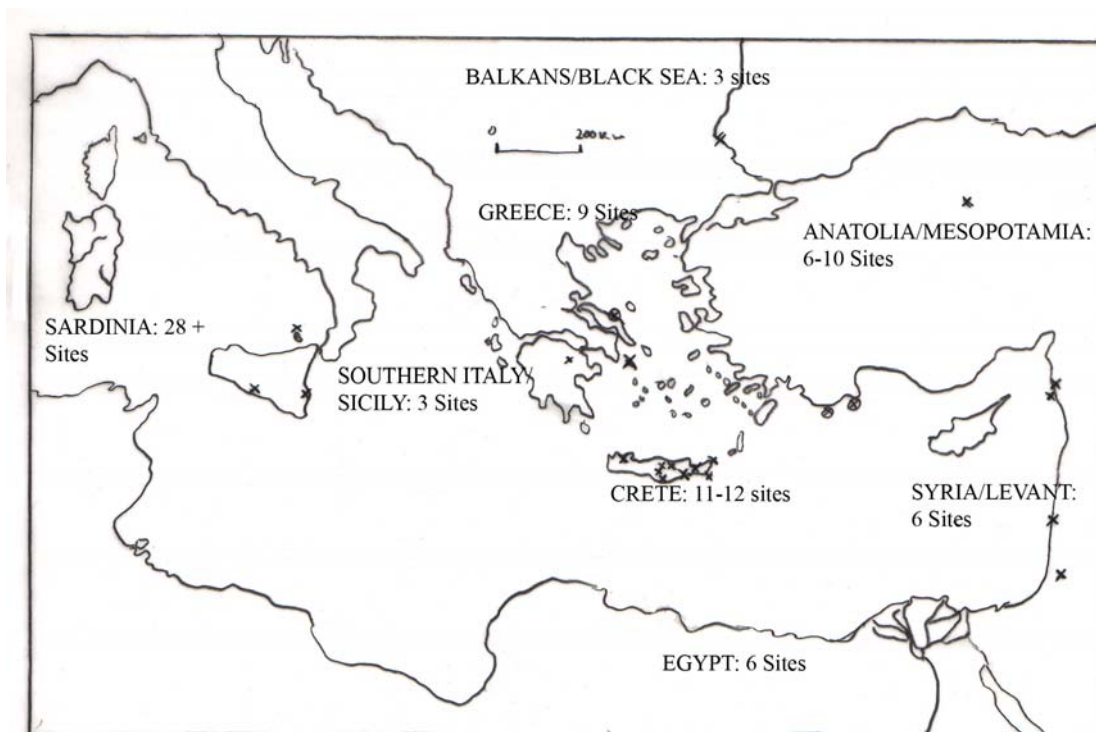

**Figure 4: Distribution of oxhide ingot finds (Modified from Gale 1999, 111. See also Appendix 2).**

The largest collection from a single site is the assemblage of 354 complete copper oxhide ingots from the Uluburun shipwreck; other large groups of ingots include thirty-four complete and seventeen fragmentary oxhide ingots from the Cape Gelidonya wreck, and a group of nineteen ingots and ingot fragments recovered from the sea off Kyme in Euboea, probably representing a ship cargo from the 16th or 15th century B.C (Figure 4).<sup>321</sup> Other reports of oxhide ingot cargoes have been made but are not substantiated.<sup>322</sup> On land oxhide ingots have on occasion been found in large

<sup>321</sup> Pulak 1997, 191, 193; Bass 1967, 52-3, 57, 61-2; Wachsmann 1998, 208-9, 211.

<sup>322</sup> Pulak (1997, 234-5; 2001, 16) and Bass (1967, 61) mention an alleged cargo of approximately two tons of oxhide ingots in the Bay of Antalya near Side which may have been salvaged early in the 20th century; Pulak also mentions a report of a second copper ingot cargo in the Straits of Samos (1997, 235). At least three oxhide ingots have been recovered from the sea in this area (Bass 1967, 61; 1986, 272; cf. Buchholz 1959, 27), although attempts to locate the wreck were unsuccessful (Pulak 2001, 16). Muhly

groups in storerooms in Minoan palaces, such as the nineteen ingots recovered from Agia Triadha, three ingots from Tyliossos, and six from Zakros.<sup>323</sup> Over thirty complete oxhide ingots and thirty-nine fragments are known from Minoan Crete alone.<sup>324</sup> On Sardinia, oxhide ingot fragments are commonly found in scrap hoards dating to the Nuragic period, particularly of the 14th to 12th centuries B.C.; currently, over thirty sites on the island have produced intact oxhide ingots or oxhide ingot fragments.<sup>325</sup>

Several attempts have been made to create an oxhide ingot typology based on archaeological finds and depictions of ingots in Egyptian tomb paintings, particularly Buchholz (1959) and Bass (1967) (Figure 5).<sup>326</sup> The earliest ingots have four small protrusions at their corners and are roughly square-shaped rather than elongated as the later types; these seem to date primarily to the 16th and 15th centuries B.C., a date based on finds from the Minoan palace finds and representations of ingots in Egyptian tomb paintings.<sup>327</sup>

---

(1998, 318) mentions a rumored cargo of oxhide ingots on a shipwreck in the Balearic Islands cited by Parker (1992, 181), but no other information is given.

<sup>323</sup> Hazzidakis 1921, 57; Platon 1971, 116; Hakulin 2004, 19-20.

<sup>324</sup> Hakulin 2004, 19.

<sup>325</sup> LoSchiavo 1998, 99-101; 2001, 133-4, 138; 2005, 400.

<sup>326</sup> Buchholz 1959, 7; Bass 1967, 52-3.

<sup>327</sup> Bass 1967, 62-7.

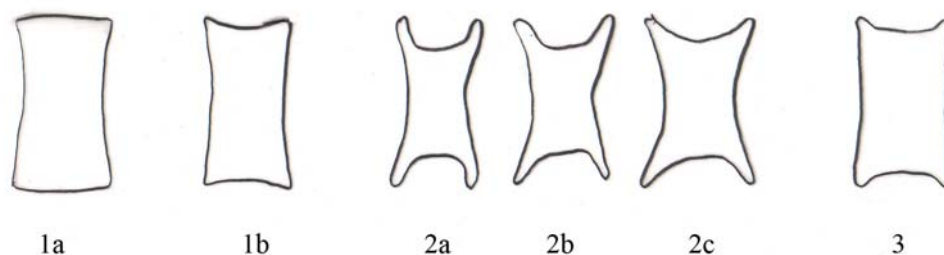

**Figure 5: Bass' modification of Buchholz's (1959) oxhide ingot typology (After Bass 1967, 53).**

However, Bass (1967, 69) noted that the shapes of oxhide ingot do not necessarily fit neatly into a chronological progression; several ingot types seem to have been in use simultaneously.<sup>328</sup> This statement has been confirmed by the oxhide ingots from the Uluburun shipwreck, which show a wide degree of variation in their shape.<sup>329</sup> The presence of five 'pillow' ingots resembling Buchholz's Type 1 on the Uluburun wreck may mean that the production of this ingot type likely continued into the late 14th century B.C. This type of ingot (Buchholz Type 1) is known from Egyptian tomb paintings dating from the 15th and 14th centuries B.C. and from the Cretan palaces of Tyliossos, Zakros, and Hagia Triadha, as well as from Kyme in Greece (Figure 6).<sup>330</sup> Its

<sup>328</sup> Bass 1967, 69: "We must conclude that the three major types of ingots cannot always be separated chronologically, but we may accept the appearance of ingots without legs as slightly earlier than the appearance of those with legs."

<sup>329</sup> Pulak 1987, 31-40; Yalçın et al. 2005, 561-8.

<sup>330</sup> Bass 1967, 52-3, 62-4; Hazzidakis 1921, 57; Buchholz 1959, 7; Platon 1971; Demakopoulou et al. 1999, 37; Pulak 2000a, 137-8. Some representations of Type 1 ingots in Egyptian tomb paintings depict the ingots as much larger than the 'pillow' ingots from the Uluburun ship, however (for example, see Bass 1967, Fig. 67, 75, and 80), although others (Fig. 64) seem to more closely approximate the size of the Uluburun examples (supra n. 298). As in later times, the sizes of oxhide ingots may have varied considerably. Another factor is Egyptian artistic conventions; in Egyptian art, objects are often shown at exaggerated scales in order to emphasize their importance (Schäfer 1974, 230-1). One example from the tribute scenes are 'Vapheio' cups in the Tomb of Senmut carried by men of Keftiu shown at exaggerated scales (Wachsmann 1987, 28, Pl. XXIII A, B).



shape may represent an early stage in the development of the oxhide ingot; they seem to date primarily to the 16th and 15th centuries B.C.<sup>331</sup>

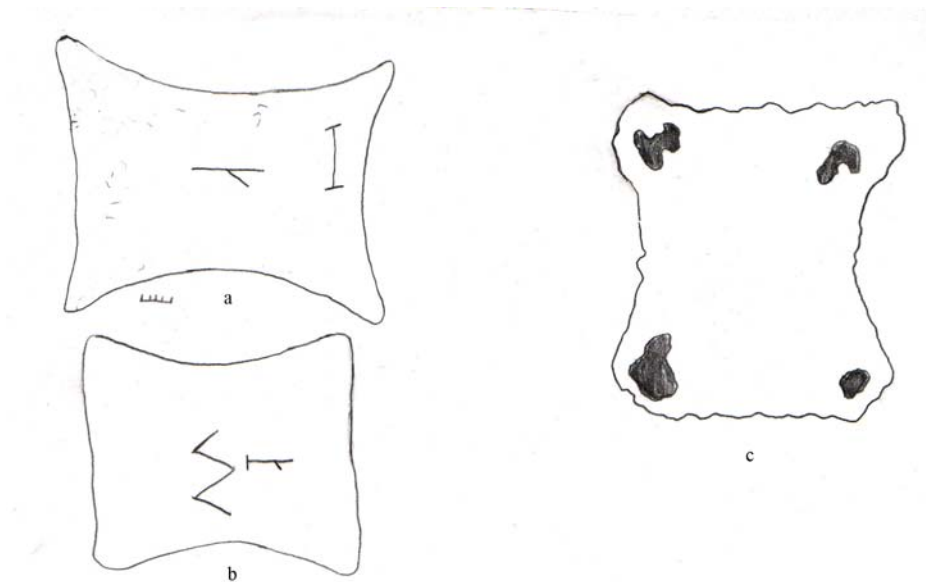

**Figure 6: ‘Type 1’ ingots from the Minoan palaces of Hagia Triadha (a, b) and Tyllisos (c) (After Evely 2000, 345; Hazzidakis 1921, Figure 31).**

Their presence on the Uluburun wreck makes this dating more problematic; if they were contemporary with the wreck, then this ingot type continued to be used in some areas up into the late 14th century B.C (Figure 7).<sup>332</sup>

<sup>331</sup> Pulak 2000a, 138; Bass 1967, 62-4.

<sup>332</sup> Pulak 1998, 195.



**Figure 7: Two of the Type 1 ingots from the Uluburun ship. These two ingots are mold siblings (Photo by the author).**

However, as a valuable raw material copper ingots could be stored or buried for long periods of time, perhaps even centuries, before being used.<sup>333</sup> Objects, which are likely metal ingots, shown on a mid-ninth century B.C. tribute scene from the throne room of Shalmeneser III at Nimrud are remarkably similar to the Type 1 ingots (Figure 8).<sup>334</sup> Although these are at least one to two hundred years more recent than the most recent dated examples of oxhide ingots, it suggests that this ingot form may have persisted for many centuries after its first appearance.

<sup>333</sup> Catling (1964, 282), Bass (1967, 15), and LoSchiavo (1989, 35) record instances where newly discovered copper oxhide ingots were melted down or in danger of being melted down in the 19th and 20th century. The recycling of ancient metal objects certainly occurred in ancient times as well.

<sup>334</sup> Mallowan 1966:2, 445, Fig. 371a; Moorey 1994, 245. Reade (1980) identifies another object carried by a porter in a different ninth-century B.C. tribute scene at Nimrud as an oxhide ingot (1980, 11, Pl. III). However, this object could also be a bag or basket of some sort.



**Figure 8: Tribute bearers, including two men carrying possible oxhide ingots (?), from a relief from the throne room of Shalmeneser III at Nimrud. Mid-ninth century BC (After Mallowan 1966, Figure 371a).**

On Type 2 and 3 oxhide ingots, the ingots' handles become more elongated, while the width of the ingots decrease in the center, forming a pronounced 'waist'.<sup>335</sup> The oxhide ingots from the Cape Gelidonya wreck, dating to c. 1200 B.C., are slightly smaller and have more pronounced incurving waists in comparison with many of the four-handled oxhide ingots from Uluburun, dating to a century before; though other Uluburun oxhide ingots closely resemble the Cape Gelidonya examples; in fact, several of Buchholz's ingot types occur on the Uluburun ship.<sup>336</sup> Thirty-four complete two-handled copper oxhide ingots as well as ten identifiable fragments of two-handled ingots were also found at Uluburun; they are roughly the same size as the four handled ingots, but are usually more roughly cast (Figure 9d).<sup>337</sup> The reason or reasons for this ingot shape are unknown. The differences between these types could represent

<sup>335</sup> Bass 1967, 53.

<sup>336</sup> Bass 1967, 54-7; Pulak 1987, 31-40; 1998, 193; 2000a, 141. An exceptionally long and narrow example was discovered at Serra Ilixi in Sardinia in the 19th century; it probably dates to the end of the Late Bronze Age in the region (13th to mid 11th centuries B.C.) (Balmuth 1984, 48; cf. Vagnetti 1999, 189; Ridgway 1996, 118).

<sup>337</sup> Pulak 1998, 193.

changes in ingot casting over time, or differences in smelting and ingot casting procedures between different copper-producing regions, communities, or even individual teams of smelters. An anomalous clover-shaped ingot (KW 1983) was also found in the Uluburun cargo. The ingot's lead isotope signature slightly overlaps copper from Laurion in Attica.<sup>338</sup> This ingot weighs 10.14 kg and has a similar mold surface to those of the 'pillow' and 'bun' ingots. The reason for the ingot's unusual shape is unclear, although it perhaps shows the influence of the oxhide ingot shape.

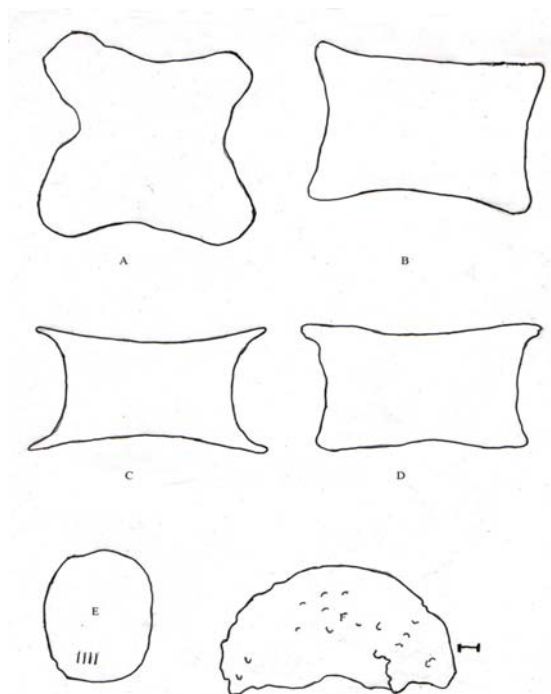

**Figure 9a-f: Copper ingot types from the Uluburun shipwreck. These include a unique clover-shaped or miniature oxhide ingot, KW 1983 (A), a Type 1 'pillow' ingot (KW 157), many four-handled copper oxhide ingots such as KW 3771 (C), and, for the first time, two-handled oxhide ingots, including KW 4501 (D). Ovoid ingots such as KW 2731 (E) and KW 1191, a plano-convex ingot, which was broken in antiquity (F), were also found (After Pulak 1998, 195; 2000a, 141-2, 145).**

<sup>338</sup> Pulak 2000a, 147-50; 2001, 21-2. The lead isotope signatures of several other recently analyzed copper ingots from Uluburun also slightly overlap the Laurion lead isotope field. C. Pulak now concludes that this does not necessarily indicate that they are made from copper from Laurion (C. Pulak, personal communication). Many of the lead fishing weights have been sourced to Laurion using lead isotope analysis, as well as a few to sources in the northern Aegean and in the south central Taurus mountains in Anatolia (Pulak 2001, 23).

Other metal ingot types were also in widespread use during the Bronze Age. These include ‘plano-convex’ or ‘bun’ ingots, cast in bowl-shaped molds or depressions; rectangular slab or bar ingots, crescent-shaped ingots in use in the earlier part of the Bronze Age, ‘ovoid’ or oblong ingots; and more uncommon types, such as ‘truncated-conical’ ingots from the Nuragic sites of Bonnanaro and Sant’ Imbenia on Sardinia.<sup>339</sup> Rectangular or slab-shaped copper ingots were sometimes produced; fragments of what appear to be rectangular ingots were found on the Uluburun shipwreck, while a stone mold for “plaque-shaped” ingots weighing several kilograms was recovered from Kültepe in Cappodocia.<sup>340</sup> Sometimes holes were cut into one end so that they could be carried on poles.<sup>341</sup> Ring- and bar shaped ingots of gold, silver, copper, and bronze were commonly used in Bronze Age Europe, the Mediterranean, and in Egypt, as shown in Egyptian and Mesopotamian iconography as well as by archaeological finds. These were typically small (no heavier than half a kilogram) and can easily be mistaken for jewelry (Figure 10).<sup>342</sup>

<sup>339</sup> Begemann et al. 2001, 48-9; Bass 1967, 81; Muhly et al. 1977, 354, 357-8; LoSchiavo 1989, 36; 1995, 47; Derckson 1997, 57; Levy et al. 2002, 429-30; Müller-Karpe 2005, 487, Abb. 3, 489-90, Abb. 6-9; Yalçın et al. 2005, 646, n. 217-8.

<sup>340</sup> Derckson 1996, 57; Müller-Karpe 2005, 489-90, Abb. 6-7, 9.

<sup>341</sup> Mallowan 1966, Fig. 371a; Wachsmann 1987, Pl. LIIB; Pulak 1998, 200.

<sup>342</sup> Lassen 2000, 241-4; Bisson de la Roque 1950, 4-8, Pl. VI-VIII; Mallowan 1966, Fig. 371a-d; Davies 1973, 21, 28, 33, 35, Pl. XVIII, XXIX-XXXV; Tylecote 1980, 196; 1987a, 243-4; Moorey 1994, 245; Pulak 1997, 243. Gold ring ingots are weighed in one scene in the Tomb of Rekhmire, indicating their use as ingots (Davies 1973, 35). One such ingot was found on the Uluburun wreck in a hoard of scrap jewelry (Pulak 2001, 243). Tin may have also been transported by the Assyrians as ring ingots or pieces of irregular scrap; some examples of tin scraps were recently excavated in Sardinia at the Nuragic site of S’ Arcu ‘e is Forros (Veenhof 1972, 34-5; cf. Fadda 2003, 138). A reference to the wearing of ‘ingots’ occurs in Papyrus Anastasi IV: “Many ingots of raw copper and bars of *dhw* [probably tin]... are on the necks of the children of Alasia as gifts for His Majesty” (Muhly 1973a, 245). The text seems to refer to individuals wearing ring or perforated bar ingots in ceremonial presentations of gifts to the pharaoh. An Early Cypriot period limestone mold for bar-shaped ingots was found at site of Marki-*Alonia*, while a 14th century BC mold for bar ingots was found at

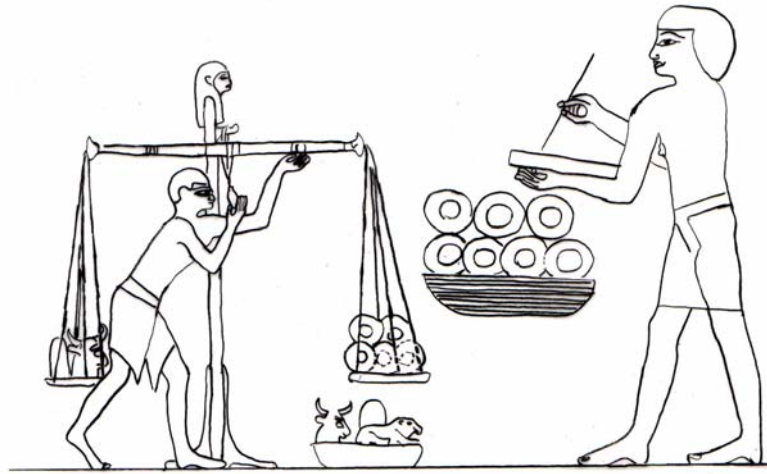

**Figure 10: Weighing ring ingots, a scene from the Tomb of Rekmire, Mid-15th century BC (After Davies 1973, Pl. LV).**

Ring- and bar-shaped ingots are extremely common in Bronze Age metal hoards from northern Europe as well, and were also manufactured and used in Anatolia in the early second millennium B.C.<sup>343</sup> Axe heads may have also served as ingots, perhaps of standard values; large hoards of axes, sometimes with casting imperfections, are found throughout much of Italy and northern Europe.<sup>344</sup> Although little evidence exists for ‘axe-ingots’ in the eastern Mediterranean, Keswani (2005, 386, 392) suggests that early examples of shafthole axes on Cyprus could have been imported from the Near

---

Alacahöyük (Fasnacht 2005, 517; cf. Yalçın et al. 2005, 646). Chains of gold rings are known from the 20th century B.C. Tôd Treasure from Egypt as well (Bisson de la Roque 1950, i, Pl. VII-VIII).

<sup>343</sup> Tylecote 1987a, 18-9; Harding 2000, 218-9; Derckson 1996, 58-9.

<sup>344</sup> Huth 2000, 177, 188-190; Maraszek 2000, 213; Pydyn 2000, 230. The use of axes as a form of ingot or perhaps even as a primitive form of currency (whether or not of a standardized weight) has precedents in Neolithic flint axe preforms which were produced and transported over long distances from flint sources in southern England (Bradley and Edmonds 1993) and ground stone axes which were exchanged in the Neolithic Mediterranean (Robb and Farr 2005, 29). Pick-shaped ingots were also traded throughout northern Italy and the Alps during the Italian Final Bronze Age (c. 1150-950 B.C.) (Pearce 2000, 111-2).

East as “major units of copper exchange” and “prestige symbols”, and that axe molds found on Philia (Late Chalcolithic/Early Bronze Age) phase site of Marki *Alonia* could have been used for making “axes or axe-shaped ingots” intended for export. Metals were also commonly transported or hoarded in the form of scrap, or old, broken, or discarded metal objects or fragments of objects as well as casting waste.<sup>345</sup>

‘Plano-convex’ or ‘bun’ ingots are very common historically, and were in use across Bronze Age Europe and the Near East in a much larger area and over a much longer period than oxhide ingots.<sup>346</sup> Plano-convex ingots were produced by pouring or tapping molten metal into either a bowl-shaped depression in the vicinity of the melting furnace or into a bowl-shaped mold.<sup>347</sup> Although it was once thought that plano-convex ingots were usually formed in the bottoms of smelting furnaces, this was often not the case; many plano-convex ingots are made of highly pure copper, which is difficult to produce in primary smelting of copper ore using Bronze Age technology (see Chapter IV).<sup>348</sup> Some plano-convex ingots have very smooth mold (lower) surfaces and were made using well-prepared molds of stone, clay, or some other material, while others have rough mold surfaces from cooling in a cruder mold or tapping pit next to the melting furnace.<sup>349</sup> The presence of plano-convex ingots alongside oxhide ingots on the Uluburun and Cape Gelidonya shipwrecks is not

<sup>345</sup> Finds of scrap metal in Bronze Age contexts are too numerous to list here; for a few important examples from the eastern Mediterranean, see Catling 1964; Bass 1967, Knapp 1988; Knapp et al. 1988; Karageorghis 2002.

<sup>346</sup> Tylecote 1962, 31-2; 1980, 192-3; Hauptmann et al. 1988, 41; Janzon 1988, 110; LoSchiavo 1988, 101; Craddock 1995, 202; Primas and Pernicka 1998, 35-7; Weeks 2003, 38. For bun ingot and slab-shaped ingots in the Eastern Mediterranean from the Late Bronze Age, see Evely 2000, 343-6; Mangou and Ioannoi 2000, 207-8, 215-6; Hakulin 2004, 54-5.

<sup>347</sup> Tylecote 1980, 192-3, 202; Rothenberg 1990, 3.

<sup>348</sup> Merkel 1986, 256; Craddock 1995, 202. Some Late Bronze Age plano-convex ingots from Timna and Sardinia contain significant impurities, however (LoSchiavo et al. 1987, 181-2; 1990, 177, 181-2; cf. Merkel 1986, 256).

<sup>349</sup> Rothenberg 1990, 3, 56-7, 66-7; Pulak 2000a, 144-5.

surprising, since a typical copper smelting or melting furnace of the period was likely to produce far less molten copper than the 20-30 kg required to make an oxhide ingot. Merkel estimates that excavated examples of Bronze Age furnaces could smelt no more than 10 kg of copper metal in a single smelt.<sup>350</sup> The smaller size of plano-convex and other ingot types was also an advantage, since it would require less effort to prepare smaller ingots for remelting; in order to use the copper in the production of an artifact, the ingot would have to be heated and broken up into small pieces, a process which was likely more difficult with the larger oxhide ingots.<sup>351</sup> Unlike oxhide ingots, most other ingot types in use in this period are usually closer in size to the finished objects they were used to produce.<sup>352</sup> Why, then, were oxhide ingots made in the first place?

The reason for the shape of oxhide ingots has been debated for many years. The oxhide ingot shape clearly became an international standard during the Late Bronze Age, when similar standardization in pottery shapes for export occurred; A. and S. Sherratt (1991, 362-3) cite oxhide ingots and ‘Canaanite’ jars as ‘bulk commodity units’ which developed in the eastern Mediterranean as a result of increased centrally

<sup>350</sup> Merkel 1986a, 257; Tylecote 1980, 194-5.

<sup>351</sup> Tylecote 1987b, 223. However, the oxhide ingots from the Uluburun shipwreck are generally thinner than the bun ingots from the same wreck; this may have made breaking the ingots easier. Tylecote (1987b, 223) notes that the ductility of highly pure copper makes copper ingots difficult to break; however, the impurities and gas porosity holes in oxhide ingots would have made the task of breaking up oxhide ingots easier, particularly if the ingot is heated (Hauptmann et al. 2002, 19).

<sup>352</sup> Very large ingots were sometimes cast in antiquity, however. Derckson (1996) refers to texts from Old Babylonian Ur in which *k/gubāru* copper ingots are listed weighing three to four talents (or c. 90-120 kg), a massive weight for a copper ingot. A tin ‘H’-shaped ingot dredged up from Falmouth harbor and presumed to date to the postmedieval period weighs about 71.8 kg; lead ingots of similar weights were also produced by the Romans (Muhly 1973a, 246; 1985c, 289; cf. Tylecote 1986, 47-9, 61-5). Such large ingots are “not easy to steal,” which may account for their size (Tylecote 1987a, 20). However, ingots of these weights are much easier to produce with lead and tin, which have very low melting points (232° and 327° Celsius, respectively) in comparison to pure copper, which needs to be heated to at least 1150° Celsius for melting and pouring (Tylecote 1986a, 16, 48-9, 61-5).



controlled production and foreign demand.<sup>353</sup> Some scholars believed that these ingots were a form of standard currency purposely shaped to resemble an oxhide and presumably related to the worth of an ox in the Bronze Age Mediterranean.<sup>354</sup> However, this theory has been discredited, besides the fact that copper in the amount of an oxhide ingot would have been worth far more than an ox, the earliest examples of oxhide ingots do not have well-developed ‘legs’ or handles, indicating that the shape was developed for another reason.<sup>355</sup> Oxhide ingots are not a standard weight (known examples weigh between approximately 16.6 and 39.5 kg<sup>356</sup>) or size, and even contemporary examples show a wide degree of variation in their shape.<sup>357</sup> The very general similarity of their size and weight may have been useful for rough calculations of value, however.<sup>358</sup> It has also been suggested that earlier oxhide ingots were meant to conform to a standard 29 kg talent.<sup>359</sup> Since no such specific weight standards appear among the Hagia Triadha ingots, the Uluburun oxhide ingots or later ingot assemblages (for example, Bass 1967, 52-7; Muhly and Maddin 1980) it is clear that

<sup>353</sup> Sherratt and Sherratt 1991, 362-3.

<sup>354</sup> Seltmann 1974, 3-5.

<sup>355</sup> Bass 1967, 69; Pulak 1998, 193.

<sup>356</sup> Muhly et al. 1980, 85, 90, 92; Buchholz 1959; Bass 1967, 53, 57; Gale 1991, 200-1; Pulak 2000a, 140-3; Hakulin 2004. The weights of the Uluburun oxhide ingots vary from about 18-30.5 kg; however, corrosion due to contact with salt water has likely reduced the weight of many of the ingots, particularly those which were more exposed on the seafloor. The heaviest oxhide ingots known are in the British Museum (37 kg) and in the Cyprus Museum at Nicosia (39 kg); both are believed to have come from Enkomi (Muhly 1979, 94). An anomalous ingot found at Cape Kalliakra in Bulgaria weighs only about 1.455 kg and is unusually small (approximately 25 cm long, 12 cm wide, and 1.4 cm thick according to Lichardus et al. 2002, 165); the ingot itself consists of about 50% copper, 32% gold, and 18% silver, and has a circular impressed mark (Hiller 1991, 209-10; cf. Kolb 2004, 593; Lichardus et al. 2002, 165, Abb. 19.1. Lichardus et al. 2002 records the composition of the ingot as containing 43% copper and 7% other impurities). This unique example may be a local imitation of imported oxhide ingots of copper or tin.

<sup>357</sup> Pulak 2000a, 138; Bass 1986, 276.

<sup>358</sup> Pulak 2000a, 138, 140.

<sup>359</sup> Muhly 1979, 95. Casting large ingots to a specific weight standard would have probably been more difficult than breaking up ingots to achieve certain weights after they had been cast. However, smaller ‘ring ingots’ of gold and bronze may have been cast to specific weight standards in the Late Bronze Age (see Lassen 2000, 241-3). These ingots were far smaller than typical oxhide or bun ingots, typically weighing no more than one mina, or approximately 500 g.

no strict standardization in the weight of oxhide ingots was obtained in the manufacture of archaeologically recovered ingots.<sup>360</sup>

The need to transport copper over long distances is currently the most accepted theory for the development of the oxhide shape.<sup>361</sup> The size of complete oxhide ingots make them somewhat difficult to transport; they are also too large to manage in casting objects unless they were broken up.<sup>362</sup> Some scholars (Buchholz 1959; Tylecote 1987a) have suggested that the handles on the ingots were used to aid in carrying them on the shoulders of a porter, as they are carried in Egyptian tomb paintings and on figures on Late Cypriot bronze stands.<sup>363</sup> It is entirely plausible that ingots were carried over long distances by porters, though perhaps not over long distances in the way shown in Egyptian and Cypriot art. Ingots may have been slung on poles carried by a pair of individuals, carried on a porter's back, or at least wrapped in some sort of padding to avoid chafing the porter's shoulders. Assyrian merchants operating in

<sup>360</sup> Bass 1967, 52-7; Buchholz 1959, 32, 34; Muhly and Maddin 1980; Pulak 2000a. The oxhide ingots from Hagia Triadha, the earliest securely dated examples, also have varying weights from 27-32 kg (Buchholz 1959, 32). Hakulin's database of Minoan ingots (2004) lists the six Zakros ingots as being the same weight (29-30 kg), though these figures may simply be a rough estimate (cf. Platon 1971, 120). Pulak (2000a, 143) found no evidence of a specific weight standard in his examination of the Uluburun oxhide ingots; however, he suggests that the weights of the Uluburun oxhide ingots may represent some attempt to conform to an approximate weight standard of 23.5 kg or more (the exact weight may have been more, since the ingots are corroded): "... they represent ingots made to a single approximate weight in the vicinity of 23.5 kg, a value that would have been much higher for the original, pristine ingots. If this is, indeed, the case, it would facilitate the ingots' handling, transportation, and tallying procedures" (Pulak 2000a, 141-2).

<sup>361</sup> See Bass 1967, 69, n. 78 for pre-1967 references; see also Pulak 2000a, 138.

<sup>362</sup> Pulak 2000a, 140, 144-5; Budd et al. 1995a, 1. A reference to the breaking up of an ingot to produce bronze objects occurs in a Hittite inventory: "They broke up 1 copper [ingot of 1] talent [in weight, dividing it into]: [from] 20 minas in wei[ght x x] they make; 6 minas [they make into] *zapiškuri*; Tarhundazalma checked it; 15 minas [they use for] 10 *zapiškuri*; [from] 20 minas 10 shekels they manufacture 10 daggers" (Kempinski and Košak 1977, 89). The porous structure of the Uluburun oxhide ingots combined with impurities in the metal allow them to be shattered by blows, probably after heating (supra n. 340); evidence of secondary score marks, and depressions from hammer blows on oxhide and bun ingot fragments confirm that this was done with some of the Uluburun ingots (Pulak 2000a, 145; Hauptmann et al. 2002, 19). The breaking up of ingots also facilitates the melting of the metal: small ingot fragments are easier to pack into a crucible and will have a larger surface area directly exposed to heat, which will make the fragments easier to melt (Bass 1967, 72).

<sup>363</sup> Tylecote 1987a, 20; Bass 1967, 62-7; Buchholz 1988, 207, 213. Bass (1967, 69, n. 78) lists other earlier scholars who advanced this opinion.

Kültepe employed porters in some instances for carrying trade items; these individuals carried loads of up to thirty kilograms in weight, or the average weight of an oxhide ingot.<sup>364</sup> Pack animals were probably used to carry oxhide ingots overland whenever possible, however. The oxhide ingot's shape may have been designed specifically for land transport: the handles would have made them more convenient to lash to a packsaddle on a donkey.<sup>365</sup> A typical donkey-load for a tin-carrying donkey in the 19th-century B.C. trade between Kültepe to Assur was about 180-190 minas (75-90 kg), consisting of 130 minas of tin wrapped in four "textiles for wrapping" and divided into two 'side packs' slung over the flanks of the animal, as well as a 'top-pack' put on top of the side packs, which usually included four to six textiles and a bundle of ten to twelve minas of 'loose tin' used to pay traveling expenses.<sup>366</sup> Donkeys laden with two to three talent of copper (60-90 kg) are also mentioned in texts from Kanish.<sup>367</sup> The carrying capacity of 180-190 minas is consistent with recorded carrying capacities of donkeys in a Roman edict of A.D. 301 and with a modern ethnographic account; A. Nibbi points out that at least two oxhide ingots of thirty-three kilograms (or more?), one slung on each side of a pack saddle, could easily be carried by a donkey.<sup>368</sup> Wagons drawn by oxen or donkeys were also used at times in the Assyrian tin trade

<sup>364</sup> Derckson 1996, 61.

<sup>365</sup> Pulak 2000a, 138; Buchholz 1959, 2, 4; Bass 1967, 69, 71. See Bass 1967, 69, to earlier attributions of the ingots' corner protrusions as handles. This identification is similar to that proposed for an 'H'-shaped tin ingot recovered from Falmouth harbor in England (see Muhly 1985c, 289 for an illustration). The 'X' or 'H' shape of Katanga crosses, a class of widely traded copper ingot currency in use in central Africa for over a thousand years, seems to have been developed for similar reasons. Katanga crosses were melted down as raw material, some types were worn as jewelry, and were frequently used as currency; prices of commodities were measured by the number of crosses (de Maret 1995, 135-44; Denk 1995, 65-71). The arms of the ingots also make them ideal for lashing or tying together in bundles, which likely aided in long-distance transport (Katanga crosses were extensively traded) (de Maret 1995, 136-41, 44).

<sup>366</sup> Veenhof 1972, 45.

<sup>367</sup> Derckson 1996, 61.

<sup>368</sup> Nibbi 1987, 82; Veenhof 1972, 45; Derckson 1996, 61. Durham (1909) records a 'packload' in a rural Albanian caravan as "one hundred *okas* (over two hundred pounds)... without counting the heavy wooden saddle" (Durham 1971, 233).

between Kanish and Assur; references to wagons carrying large amounts of copper, up to 20 talents (or approx. 600 kg) are recorded.<sup>369</sup> Nibbi also suggests that the ingots were “wrapped fairly thickly for the metal not to wear through its cover during the trip to blister and pierce the skin of an animal which represented a valuable asset to its owner.”<sup>370</sup> This hypothesis is tentatively supported by the traces of fibers or matting found concreted to seven of the oxhide ingots from the Cape Gelidonya wreck and on several of the bun and oxhide ingots from the Uluburun shipwreck.<sup>371</sup> Nibbi’s theory that wrapped ingots are shown on several Middle Kingdom (c. 2000 B.C.) sarcophagi is somewhat far-fetched, however, since archaeological examples of oxhide ingots are not known for up to four hundred years after the sarcophagi were made, and do not otherwise appear in Egyptian iconography until the 15th century B.C.<sup>372</sup>

The Uluburun and Cape Gelidonya metal cargoes show that virtually any shape of ingot known from the Bronze Age was deemed suitable for carrying aboard a ship, either in containers or separately. However, the flat shape of oxhide ingots was put to good use on the Uluburun wreck, where the ingots were stacked on top of thorny burnet dunnage in layers; these layers formed a herringbone pattern, probably to minimize the shifting or slipping of the ingots during the voyage.<sup>373</sup> Their shape may therefore have been designed partially to facilitate their stowage on ships as well.

Published records of Assyrian merchants at Kaniš show that large amounts of tin (a

<sup>369</sup> Derckson 1996, 64-6.

<sup>370</sup> Nibbi 1987, 82.

<sup>371</sup> Several oxhide and bun ingots which were recovered from the Uluburun shipwreck had significant traces of matting adhering to their surfaces (for example, the bun ingot KW 2792). Pulak proposes that the bun ingots were stored in baskets or sacks based on their distribution on the wreck site; in some cases, bun ingots with the same secondary marks seem to have been stored together (C. Pulak, personal communication). For similar matting was found between ingots on the Cape Gelidonya wreck, see Bass 1967, 44.

<sup>372</sup> Nibbi 1987, 59-71, 78, 81; Bass 1967, 52-7.

<sup>373</sup> Pulak 2000a, 140-1.

total of 25,000 minas, or about twelve tons, are recorded) was imported overland to Anatolia from perhaps as far east as Afghanistan or northwestern Iran.<sup>374</sup> Considering that the Uluburun ship carried about eleven tons of metal on one voyage, and that the Assyrian merchants' tin exports to Kanish have been estimated at about 1-1.6 tons annually, obviously sea transport of metals was far more efficient (several hundred donkeys at least would be needed to carry the metal cargo of the Uluburun ship), and probably faster as well.<sup>375</sup>

The oxhide ingot shape does not seem to have a clear superiority over other ingot types in terms of ease of transport, accounting, or weighing, however. Several different types of ingots have been found in the cargoes of the Bronze Age ships, and while the handles or 'ears' on oxhide ingots may have been useful for lashing the ingots to a pack saddle, they were likely of little use for stowing ingots in a ship's hold.<sup>376</sup> Smaller ingots could be stored in containers or wrapped into bundles or packages. In the Kanish/Kültepe texts, Veenhof (1972, 35-7, 44) notes references to "textiles for wrapping" of tin loads by Assyrian merchants, as well as references to *ilum*, or bags, probably of leather, in which tin and copper (in amounts up to 100 minas, or approximately 50 kg) were carried.<sup>377</sup> He suggests that the tin was likely in the form of small, irregular pieces that could easily be wrapped into bundles or placed in bags or containers of leather sealed with clay bullae.<sup>378</sup> According to Derckson,

<sup>374</sup> Wertime 1978, 3; McKerrell 1978, 20-1; Muhly 1973a, 260, 303.

<sup>375</sup> Pulak 2001, 18; Larsen 1976, 90-1; McKerrell 1978, 21; Muhly 1980, 33; Moorey 1994, 10. Since only about 3,000 of the estimated 18,000 tablets recovered from Kanish have been published, McKerrell's estimate must be regarded as tentative (Derckson 1996, 1). Moorey (1994, 12) estimates that laden donkeys or mules could travel only 15-25 miles a day, and would be unsuitable for certain environments (desert). Despite the problems presented by weather-- contrary winds, storms, etc.-- a sailing ship could probably do much better in most circumstances.

<sup>376</sup> Pulak 2000a, 138.

<sup>377</sup> Veenhof 1972, 35-40.

<sup>378</sup> Veenhof 1972, 32-5. Seal impressions of the merchants involved in the financial transaction or in the transport of goods were made on the bullae after the metal was weighed to prevent tampering;

copper ingots were also frequently broken up into small pieces (referred to as “broken-up” or “small-sized” copper) and packed into sealed bags.<sup>379</sup> There are several possible reasons for this practice:

It offered a chance to check the ingot’s quality and prevent surprises like in one of the plano-convex ingots from Bahla in Oman, where the core of the ingot consists of slag... Secondly, it enabled the trader to weigh a given amount with greater accuracy, and lastly, it may have facilitated transport.<sup>380</sup>

In one text from Kanish, an Assyrian merchant selling wool to some local Anatolians refuses an initial offer of one unit of copper in the form of an ingot for three units of wool and later accepts an offer of one unit of ‘small-sized pieces of copper’ for two units of wool.<sup>381</sup> Derckson notes that

Not only was the price offered for the wool 50% higher than before, but also the quality of the copper received as proceeds could be better assessed. While a complete ingot might contain impurities not visible on the outside, one broken up in small pieces would easily show the impurity a metal might contain.<sup>382</sup>

At least four words for ingot types, which may have been recognized as standard types, have also been identified from the Kanish texts: *kabbārum* (possibly from a verb meaning “to become fat, thick, heavy”), possibly bun or slab ingots; *kakkartum*, or bun ingots, which weighed from a few kilograms to one talent; *patallum*, (“anklets”), probably ring-shaped ingots; and *sadālum*, which has an unknown

---

some texts mention the breaking of the seal on these bags as a breach of contract (Veenhof 1972, 32-5).

<sup>379</sup> Derckson 1996, 25, 41, 60.

<sup>380</sup> Derckson 1996, 25, 41, 60; Weeks 2003, 38. Another example of ancient fraud in ingot production was found on the Uluburun shipwreck; one of the plano-convex tin ingots contained “unmelted bits of lead scrap or bars at its core” (Pulak 2000a, 155).

<sup>381</sup> Derckson 1996, 58-9.

<sup>382</sup> Derckson 1996, 59.

meaning but may refer to bar-shaped ingots.<sup>383</sup> Molds for bar-shaped ingots (which could have been bent or forged into rings) and rectangular ingots were excavated at Kanish and other Anatolian sites, and fragments of irregularly shaped ingots and possible copper bun ingots (identified by the excavator as weights) were found at the site as well.<sup>384</sup> Derckson suggests that in at least some cases ingots of a standard weight may have been recognized and traded in Anatolia, since some texts from Kanish list numbers of ingots without weights.<sup>385</sup> However, a text from Kanish recording a transaction involving five *kakkartum* also lists their weight, suggesting that this word at least refers only to the ingots' shape.<sup>386</sup> Bass makes the same point concerning copper oxhide ingots recorded in two Linear B texts from Knossos, where both the number of ingots and their total weight is given.<sup>387</sup>

The variety of ingot types found on Bronze Age sites and in the Kanish texts corresponds closely with archaeological finds from throughout the Bronze Age Near East and Europe; some standardization of ingot sizes and types seems to have occurred in specific times and places, but most finds of raw metal from the Bronze Age, whether in foundry or scrap hoards or ship cargoes, includes several different types of ingots, often broken into pieces and accompanied by scrap metal in the form of broken

<sup>383</sup> Derckson 1996, 58-9.

<sup>384</sup> Derckson 1996, 57; Müller-Karpe 2005, 489-90.

<sup>385</sup> Derckson 1996, 41, 60. Copper ingots of standardized weights were also made in the Bronze-Age Alps, beginning around 2000 B.C. Fragments of bronze sickles may have also been used as a form of currency in this region (Shennan 1999, 359).

<sup>386</sup> Derckson 1996, 59.

<sup>387</sup> Bass 1967, 71. The texts are Oa 730, which records 60 ingots weighing 52 2/30 talents (or approximately 1509.93 kg of copper in the form of ingots of an average weight of 25.1 kg, assuming one talent = 29 kg), and Oa 733, which records ten ingots weighing six or eight talents (or an average

or worn out copper or bronze objects. The variety of forms in which raw metal from Bronze-Age sites is found suggests that other factors are involved in the adoption of oxhide ingots as a major ingot type in the interregional trade in metals. Pulak suggests that the oxhide ingot shape may have served as "something of a 'trade-mark' that indicated the ingots were being exported from an area under a certain sphere of influence," much as amphora shapes came to denote the container's origin, contents, and quality in later periods.<sup>388</sup> However, copper bun ingots found on the Uluburun ship also seem to have been made from copper from the same source as the oxhide ingots.<sup>389</sup> The shape of the ingot itself may have been considered a sign of its purity and origin, similar enough of an assurance of its quality and origin. Chemical and metallographic analyses have shown oxhide ingots to be of a highly uniform quality, lending support to this hypothesis.<sup>390</sup> Lead isotope analyses have traced most known oxhide ingots to copper sources in Cyprus, indicating that they may have been adopted as the primary or standard ingot type exported from Cyprus (see Chapter V).<sup>391</sup>

Tylecote has pointed out that large ingots of 30 kg or more are "not easy to steal", unlike small bar or ring ingots.<sup>392</sup> Metal smuggling to avoid customs payments may have been common; iron (*aši'um*) was a commodity sometimes concealed and

---

of 17.4 or 23.2 kg per ingot, based on a 29 kg talent). These figures are well within the range of weights of archaeologically recovered oxhide ingots.

<sup>388</sup> Pulak 2000a, 138; Alpözen 1995, 23-4.

<sup>389</sup> Hauptmann et al. 2002; Gale 1999; 2000; Pulak 2000a, 149, fig. 15; 2001, 21-2;

<sup>390</sup> Supra n. 20.

<sup>391</sup> Stos-Gale and Gale 1994, 116-21; Gale 1999; 2000; Joel et al. 1995, 45-7.

<sup>392</sup> Tylecote 1987a, 20.



smuggled by Assyrian merchants in Anatolia.<sup>393</sup> Attempts to standardize ingot shapes into a large, unwieldy, ‘difficult-to-steal’ shape may represent attempts by one or more centralized authorities to control the production and distribution of metals. The circulation of scrap metal and small pieces of ingots are perhaps more suited to smaller-scale, decentralized trade than large oxhide ingots. Finds such as the enormously rich, relatively homogenous metal cargo of the Uluburun wreck argue for strong centralized control of the production and export of copper.<sup>394</sup> Several scholars argue that an increase in decentralized ‘commercial’ trade began in the 14th and 13th century B.C. at the expense of centralized palatial economies, and that increased access to metals by ‘sub-elites’ was a part of this trend.<sup>395</sup> Perhaps the gradual abandonment of the oxhide ingot shape was also a symptom of this change. Oxhide ingots are large, unwieldy, and would probably require additional labor and resources to make than smaller ‘bun’ ingots or other ingot types weighing only a few kilograms, which in any case were likely to be broken up into smaller pieces for weighing, transport, or use in bronze production. A guarantee of uniform quality, as well as a desire to keep metal wealth under tight control, were likely important factors in the development and extended use of the oxhide ingot shape in the Late Bronze Age.

<sup>393</sup> Veenhof 1972, 306, 308; Derckson 1996, 57.

<sup>394</sup> Sherratt 1994, 63-4. The fragmentary nature of most of the tin ingots from Uluburun suggests a less firm or centralized control of the import and/or production of tin; however, the sheer size of the tin cargo seems to indicate that only a ruler or high-ranking palace elite could have assembled the cargo.

<sup>395</sup> Artzy 1994; 1995; 1998; 2006, 60-1; Liverani 1987, 71; Sherratt 1994; 1998; 2000.

Bronze Age tin ingots were also made in a variety of shapes, many similar or identical to the shapes of copper ingots. Ingots found off the coast of Israel, which likely date to the Bronze Age, are in the form of rectangular slabs, in irregularly shaped bars or strips, and in whole or partial plano-convex shapes, in some cases weighing up to 27 and 37 kg.<sup>396</sup> A tin ingot or ingot fragment was recently found in a LM IB storeroom at Mochlos, in a building identified as a ‘ceremonial center’ and in association with a bronze trident.<sup>397</sup> The ingot was completely corroded into tin oxide and only later identified through lab analysis.<sup>398</sup> The negative impression left in the soil by the ingot was cast in plaster; ingot was roughly triangular in shape, but is perhaps more likely a fragment of a rectangular or slab-shaped ingot.<sup>399</sup> Several tin ingot types were recovered from the Uluburun ship. The oxhide and slab ingots which had been cut into quarters are the most common types of tin ingots recovered from the Uluburun shipwreck; fifty-two quarter-oxhide ingots (along with five half-ingots and three whole ingots) and fourteen quarter-slab ingots (along with one half-slab, five whole ingots, and two ingots which are possibly whole ingots) were recovered from the site (Figure 11).<sup>400</sup> One complete and three partial plano-convex tin ingots were also recovered from the wreck, as well as twenty-five ingot fragments of indeterminate types. The rectangular slab ingots from the Uluburun shipwreck had holes of two to

---

<sup>396</sup> Galili et al. 1986, 25, 29; Maddin et al. 1977, 44-5; Misch-Brandl et al. 1985, 10, Fig. 3.2-3; Kassianidou 2003, 112-3.

<sup>397</sup> Soles 2005; Whitley 2005, 102.

<sup>398</sup> Whitley 2005, 102.

<sup>399</sup> The recently published report of this find (Whitley 2005) is somewhat vague in this respect, perhaps due to the poor state of the artifact’s preservation: “After the removal of the tin, a plaster cast was made of this pocket which reproduces the original shape of the ingot. With two straight sides, joining at a right angle, and an irregular line opposite, it bears a remarkable resemblance to a tin ingot found on the Uluburun shipwreck” (Whitley 2005, 102).

three centimeters in diameter cut into them, probably to aid in tying them over a pack-saddle or perhaps to insert a pole into the hole so that porters could carry several slab ingots on a pole between them (Figure 12).<sup>401</sup>

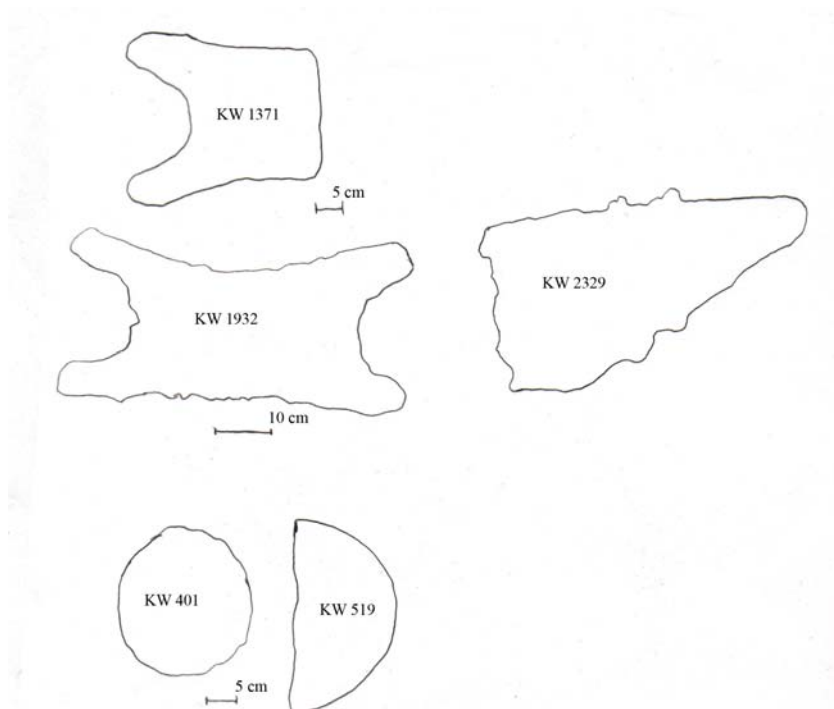

**Figure 11: Tin ingot types from the Uluburun ship: oxhide, wedge-shaped, and plano-convex (After Pulak 2000a, 151).**

Pulak believes it is “unlikely” the ingots were cut into quarters to divide them into more manageable weights, since the copper oxhide ingots were for the most part left complete. He suggests that they are in smaller pieces because they may have been “cut down to smaller sizes at their point of receipt... perhaps for use in various

<sup>400</sup> Three complete tin oxhide ingots and one half-ingot were recovered from the wreck as well; see also Yalçın et al. 2005, 572-5, n. 47-61.

<sup>401</sup> Pulak 2000a, 138. Wachsmann and Raveh (1984, 172), following Davies (1932), propose this function for a similar hole in a fragmentary lead ingot recovered from Ha Hotrim. Similar holes are seen in metal ingots carried by porters in a scene from the tomb of Amenemopet at Thebes, dating to the reign of Thutmose IV (Wachsmann 1987, 50-1, Pl. LII: B).

transactions”, so that the entire tin cargo was assembled through various exchange mechanisms rather than direct contact with the primary source of the tin.<sup>402</sup> This is likely, since, unlike copper sources, large tin sources are not available in the eastern Mediterranean (see Chapter V). Pulak also notes, however, that the tin ingots, being highly pure, were likely far easier to cut with a hammer and chisel than the copper ingots, which probably would have required heating in an open fire and beating with sledge hammers to break into smaller pieces.<sup>403</sup>

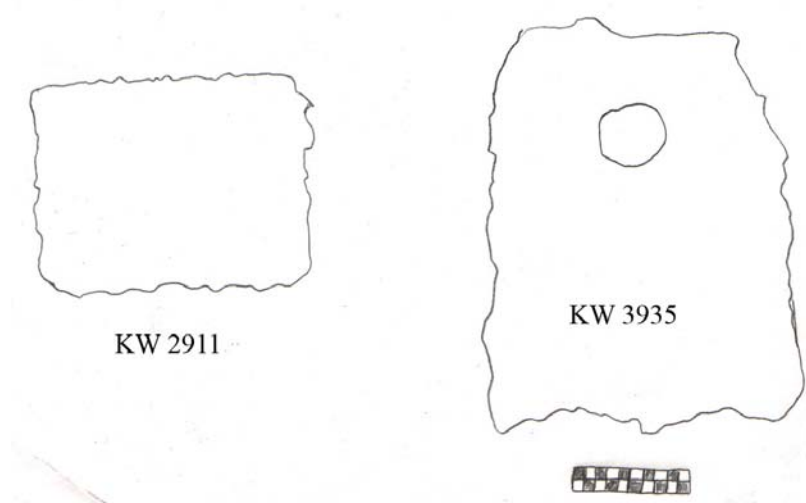

**Figure 12: Other tin ingot types from the Uluburun wreck: KW 2911, a rectangular ingot, and KW 3935, an ‘anchor-shaped’ ingot (After Pulak 2000a, 151).**

<sup>402</sup> Pulak 2000a, 152-3.

<sup>403</sup> Pulak 2000a, 152; Van Lokeren 2000, 275-6.

*Incised and Impressed Marks on Bronze Age Ingots*

Marks on oxhide ingots have been classified as either ‘primary’ (impressed) or ‘secondary’ (incised) marks.<sup>404</sup> ‘Primary marks’ were made by pressing a brand into the metal while it was still soft, while some stamps on the Cape Gelidonya wreck’s ingots were made by forming the sign in relief in the bottom of the mold, leaving a mark in the ‘smooth’ or mold surface of the ingot.<sup>405</sup> Since these signs would have been made before the metal of the ingot had cooled, these marks are therefore probably founders’ marks, used to signify the ingot’s place of production, the degree of purity of the metal, or the metallurgist or group of metallurgists who made the ingot (Figure 13).<sup>406</sup> Based on experimental attempts to stamp ‘primary marks’ into cast copper, Tylecote concludes that green wood or terracotta are the most likely materials used to make these stamps, since they can resist the heat of molten copper better than other materials (such as bronze or dry wood).<sup>407</sup> None of the Uluburun ingots have primary marks that were part of the original mold, as seen on a majority (twenty-seven) of the Cape Gelidonya ingots, as well as on oxhide ingots from San d’Antioco di Bisarcio in Sardinia and Enkomi on Cyprus.<sup>408</sup>

---

<sup>404</sup> Bass 1967, 72.

<sup>405</sup> Bass 1967, 72.

<sup>406</sup> Bass 1967, 72.

<sup>407</sup> Tylecote 1982a, 94-5.

<sup>408</sup> Bass 1967, 72-3; Catling 1964, 266-8, Pl. 49 a, c, n. 370; Vagnetti and LoSchiavo 1989, 224-5; Sibella 1996, 10. Eight of the nineteen complete oxhide ingots from Hagia Triadha on Crete (perhaps the earliest oxhide ingots known) as well several ingots from Serra Ilixi in Sardinia also have incised marks (Buchholz 1959, 32-4, 38-9; LoSchiavo 1988, 98; Evely 2000, 343, 345).

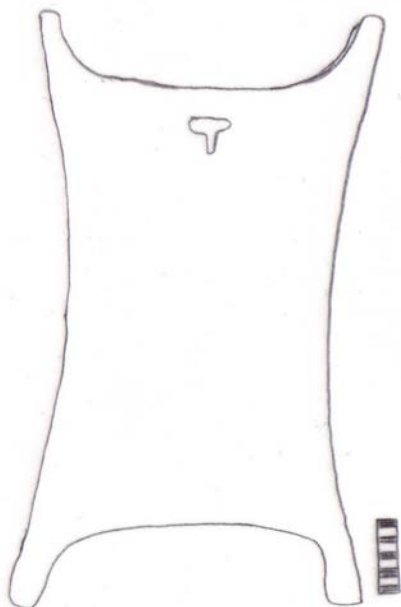

**Figure 13: Oxhide ingot with T-shaped impressed mark from Enkomi (After Schaeffer 1952, Pl. LXIII).**

‘Secondary’ or incised marks are the only type of marks found on the Uluburun shipwreck’s ingots, although only four of the Cape Gelidonya ingots are inscribed in this way.<sup>409</sup> Four tin ingots from the Israeli coast have also been dated to the Late Bronze Age based on incised marks resembling Cypro-Minoan signs.<sup>410</sup> Like the signs on the Uluburun ingots, these were made with a chisel sometime after the casting of the ingots, anywhere from the place of manufacture to their place of deposition.<sup>411</sup>

Over 187 oxhide ingots and oxhide ingot fragments from the Uluburun shipwreck were incised with secondary marks; these consist of at least 52 different types.<sup>412</sup> At

<sup>409</sup> Bass 1967, 53, 57; Pulak 2000a, 146; Yalçın et al. 2005, 561, 569-71.

<sup>410</sup> Pulak 2001, 239.

<sup>411</sup> Pulak 2000, 146; Bass 1967, 72-3.

<sup>412</sup> These figures are based on my preliminary notes from post-conservation cataloging of the oxhide ingots in the summers of 2003 and 2004 under C. Pulak; these numbers include KW 1983, the clover-shaped ingot, and the two-handled ingots. Thirteen of these ingots have two incised marks and three

least sixty-two of the bun ingots also have incised secondary marks, all except three on their mold surfaces. Only seven main types of marks are found on the bun ingots, all but one of which are replicated or have close variants on copper oxhide ingots.<sup>413</sup> Around thirty of the approximately 110 tin ingots and ingot fragments recovered from the wreck also had incised marks of some kind. At least eight different signs appear on the tin ingots; about half of these marks (16) appear to be score marks or chisel cuts made during the breaking up of the ingots, while of the remaining seventeen marked ingots, nine types of symbols are found, five of which are also found on either the oxhide and bun ingots.<sup>414</sup> The reason or reasons for the sheer variety of these marks is unknown. The presence of some of the same signs both on copper and tin ingots

---

have three incised marks. These numbers are substantially higher than those published by Pulak, who identified “at least 160” marked ingots (1997, 235); Pulak and Sibella identified 32 different incised signs on the ingots during preliminary research, before all of the ingots had been cleaned and conserved (see Pulak 1998, 194-6, and Sibella 1996). Other incised and impressed marks on oxhide ingots and other Bronze Age copper, tin, and lead ingots have been published in several sources (Bass 1967, 72; Schaeffer 1952, Pl. LXIII; Masson 1972; Buchholz and Karageorghis 1973, 277-9; Seltman 1974, 3-4; Misch-Brandl et al. 1985, 9-10, Fig. 1.7, 3.3; Raban and Galili 1985, 326-8; Galili et al. 1986, 29-34; Evely 2000, 343, 345, 641-9; Kassianidou 2001, 112-3; Whitley 2005, 103). An extensive literature on Bronze Age potters’ and masons’ marks and Cypro-Minoan signs has been assembled over many decades; this material is potentially very significant for understanding the marks on Bronze Age ingots, but an extensive treatment of these sources is beyond the scope of this study.

<sup>413</sup> Pulak (2000a, 146). Only the ovoid ‘bun’ ingots have a mark that is clearly not found on the rough or mold surfaces of the oxhide ingots; significantly, all have variants of the same mark, made with four parallel chisel strokes. I suggest the inclusion of ‘variants’ of incised marks in this count for several reasons. The incised marks on the Uluburun ingots are often fairly complicated and in many cases seem to have been made in a careless manner, so that slight variations could have been unintentionally made in a particular mark. This was unlikely to be a problem with the impressed marks on later ingots, since the stamps would have taken some time to prepare; this could be a reason why incised marks, which are the only type of marks found on the Uluburun metal cargo, are almost entirely replaced on the later Cape Gelidonya ship with impressed marks; at least twenty-seven of the whole and halved copper oxhide ingots have impressed marks, while only four have incised marks, which appear on two ingots also bearing impressed marks (Bass 1967, 52-7). Switching to stamped marks may have been a way of avoiding confusion. Secondly, the preservation of some incised marks on the Uluburun ingots is poor; the surfaces of many of the ingots were subject to significant saltwater corrosion, or may have been damaged during the mechanical cleaning of the ingots. As a result, recording the ingot marks is in some cases a somewhat subjective process. For these reasons an accurate count of the number and type of incised marks on the Uluburun ingots is difficult and to some extent subjective.

<sup>414</sup> These figures are based on the 2005 version of the preliminary catalog of the Uluburun tin ingots as compiled by C. Pulak, W. Van Duivenvoorde, and others from documentation made during the excavation and conservation of the artifacts. The number of tin ingot fragments is approximate due to the fact that some ingot pieces were very badly corroded.

suggests to Pulak that the incised signs were added during transit or at a point of receipt rather than at the production site.<sup>415</sup>

Overall, a little over half (53%) of the whole copper oxhide ingots and bun ingots (52%) from the Uluburun ship have incised marks, while almost three-quarters (70%) of the complete and halved copper oxhide ingots from Gelidonya (though none of the bun or slab ingots) have either impressed or incised marks.<sup>416</sup> The marks on the Cape Gelidonya ingots show as great a variety— twenty-three different marks on thirty-nine ingots—as are seen on those from Uluburun dating to a century before. So, while the increased use of impressed marks perhaps suggests some increasing standardization in ingot production, the great variety in ingot marks fails to lend further support to this hypothesis.<sup>417</sup>

The exact function of both the primary and secondary or incised marks on ingots are unknown. Similar to the ‘Cypro-Minoan’ marks found on some Late Bronze Age pottery from Cyprus and the Aegean, they may denote ownership of the ingots by specific individuals or groups, the receipt of the ingots as payment, tax, or tribute in a central collecting area, or the payment of customs duties on the objects.<sup>418</sup> The incision of the marks on the Uluburun ingots rather than the incorporation of the raised signs in the ingot molds suggest to Pulak that they were made at some point of receipt and collection rather than at the site of production.<sup>419</sup> This hypothesis is supported by the presence of several of the same marks on the tin and copper ingots: “As tin and

---

<sup>415</sup> Pulak 1997, 240.

<sup>416</sup> Bass 1967, 52-7, 78, 81-2.

<sup>417</sup> Bass 1967, 52-7, 72.

<sup>418</sup> Hirschfield 1990, 75-6, 81; Bass 1967, 73-4; Ventris and Chadwick 1973, 29, 40.

<sup>419</sup> Pulak 1997, 240.



copper would have been mined in different geographical regions, it is highly unlikely that the same mark would have been incised on ingots of dissimilar metals and diverse origins unless this was done at a center that handled both ingot types during the distribution process.”<sup>420</sup> Some ingots have two or as many as three marks, perhaps indicating that they passed through the hands of several individuals or through several locations before becoming part of the ship’s cargo; however, none appear to be inscriptions of two or more adjacent signs, since the symbols almost always appear on different areas of the ingots and never adjacent to each other.<sup>421</sup> Several broken ingots and ingot fragments from the Uluburun shipwreck have the same symbol on both pieces of the original ingot.<sup>422</sup> Between twenty-five and twenty-eight of these ingots also have chisel marks on their sides, possibly serving a different function (such as tallying or counting groups of ingots?); eleven different types of side marks have been identified (Figure 14).<sup>423</sup>

---

<sup>420</sup> Pulak 1998, 196.

<sup>421</sup> This is in contrast to some of the incised pot marks from Enkomi, which have inscriptions of two or three adjacent signs (Hirschfield 2002, 60).

<sup>422</sup> These include KW 3102a and b, and L 473 (two fragments of the same ingot).

<sup>423</sup> The side marks were examined during research in the summers of 2003 and 2004. The identifications of three of the twenty-eight side marks on oxhide ingots are tentative. Sibella (1996, 10) identified six of the marks on the sides of the ingots, but at the time her article was published, conservation treatment had not been completed on many of the ingots.

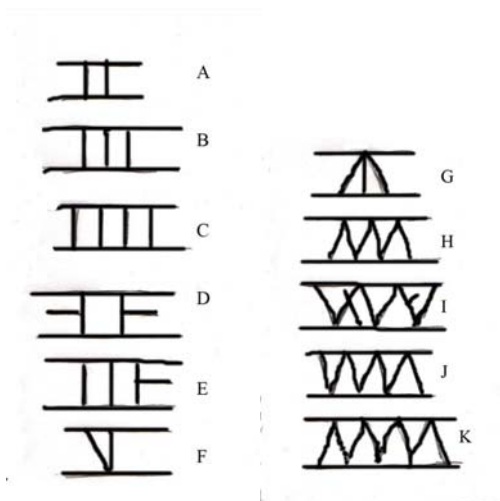

**Figure 14: Chiseled marks made on the sides of the copper oxhide ingots from Uluburun. Twenty-seven marks have been identified in all: one example of Type A, five of Type B, three of Type C, one of Type D, four of Type E, two of Type F, two of Type G, six of Type H, and one each of Types I, J, and K (the rough surface edges of the marks are closest to the top of the page).**

Symbols on ingots as well as other Bronze-Age artifacts (particularly pottery) have often been compared to symbols in various ancient scripts, especially Linear A and B, and the ‘Cypro-Minoan’ script developed on Late Bronze Age Cyprus.<sup>424</sup> These may have no relation to an actual writing system, however, despite the similarity of some signs to Cypro-Minoan or Linear B symbols; many of the symbols are very simple and could have been independently invented.<sup>425</sup> Ventris and Chadwick, the decipherers of the Linear B script, argue against this line of interpretation, stating that “owners’, potters’, bronze founders’ and masons’ marks” should be “clearly distinguished from writing in the true sense of the word... their forms generally have only a fortuitous resemblance to alphabetic or linear writing signs,” and that

<sup>424</sup> Ventris and Chadwick 1973, 29, 63; Bass 1967, 72-4; Seltman 1974, 3, n. 4; Hood 1987; Evely 2000, 641-9; Kassianidou 2003, 112-6.

<sup>425</sup> Ventris and Chadwick 1973, 29.

attempts to bring these marks into systematic connexion with regular scripts are very uncertain, since their common denominator is generally no more than the fact that they are the patterns most easily made by a limited number of straight strokes. We may have to conclude that some of the Mycenaean signs may have no external ‘derivation’ at all, other than the calligraphic fantasy of their inventors.<sup>426</sup>

Ventris and Chadwick’s skeptical approach to symbols on Late Bronze Age trade goods is shared to a great extent by N. Hirschfield, who has studied marks on pottery at Late-Bronze-Age sites, including Enkomi on Cyprus:

Can we truly assume that the marks on pottery from LBA Cyprus are evidence for literacy? As it stands, the claim is based on assumption rather than on methodical evaluation. Furthermore, the study of potmarks from LBA Cyprus is truncated by focus on that one question. In their place and context, potmarks focused as something other than evidence of script. Although my approach to the study of potmarks does not ignore the ties with script and the potential implications, instead it concentrates on attempting to understand the potmarks in terms of their function(s) as marks on pottery.<sup>427</sup>

In Hirschfield’s study of the use of potmarks in Late Cypriot Enkomi, she notes only twenty-five of the over 250 recovered marked pottery vessels have ‘inscriptions,’ defined as “Two or more marks located adjacent to one another, in alignment, and made using the same tool.”<sup>428</sup> By this definition, none of the marks on oxhide ingots and only a small number on tin ingots discovered off the Israeli coast can be considered as candidates for Bronze Age ingots with ‘inscriptions.’<sup>429</sup> However, studies of marks on Late-Bronze-Age pottery may provide clues to the origin and use of these marks. For example, incised marks seem to be more closely associated with

<sup>426</sup> Ventris and Chadwick 1973, 29, 40.

<sup>427</sup> Hirschfield 2002, 54.

<sup>428</sup> Hirschfield 2002, 60.

<sup>429</sup> Kassianidou 2003, 112-3; Raban and Galili 1984; Wachsmann 1985; Galili et al. 1986.

areas with significant Cypriot contacts (such as Ugarit). Incised marks also occur on Mycenaean pottery from Cyprus and on rare examples from the central Mediterranean, but are rare in Greece and the Aegean except at Tiryns.<sup>430</sup> More than one marking system may have been used on traded pottery vessels, however; marks resembling symbols in the Cypro-Minoan script are found on Cypriot and Aegean vessels from Enkomi, but amphoras from the site seem to have been marked using a different system.<sup>431</sup> Hirschfield concludes “The Cypro-Minoan-related marks must have been made by people familiar with the Cypro-Minoan script, very likely (although not absolutely necessarily) Cypriots. Non-Cypro-Minoan signs on amphoras, however, do not necessarily indicate non-Cypriot inscribers.”<sup>432</sup> Although the evidence for the uses of writing and the extent of literacy on Cyprus is somewhat problematic, Cypriot merchants may well have been literate, as many of their Near Eastern counterparts were; two wooden diptychs found on the Uluburun ship possibly used for a cargo inventory suggests another link between literate merchants and the trade in metals.<sup>433</sup> Hirschfield’s research has led Kassianidou to argue for major Cypriot involvement in copper and tin export based partly on the hypothesis that incising marks on ingots, like marking pottery, is a specifically Cypriot practice.<sup>434</sup> The probable Cypriot source of most copper used to make oxhide ingots also indicates that the signs on Bronze Age ingots were likely made by Cypriot merchants, metallurgists, or customs officials.<sup>435</sup>

<sup>430</sup> Hirschfield 1990, 3, 36, 83; 2001.

<sup>431</sup> Hirschfield 2002, 93-4.

<sup>432</sup> Hirschfield 2002, 94.

<sup>433</sup> Bass et al. 1989, 10-1; Pulak 1997, 252; Smith 2002, 7-10. Bachhuber (2006, 354) notes that wooden writing boards were in use in Old Kingdom Egypt, and that Late Bronze Age Hittite and Ugaritic texts contain several references to wooden writing boards. They were used both in temple and palatial administration and in the conveying of messages to foreign palaces; one Hittite text also mentions the inventorying of “tribute lists” from different locales in Anatolia, Syria, Cyprus, Egypt, and Babylonia (Bachhuber 2006, 354). It seems likely that the diptychs were either carried by messengers or by merchants for a register of the ship’s cargo (Pulak 1997, 252; Symington 1991; Bachhuber 2006, 354).

<sup>434</sup> Kassianidou 2003, 114-7.

<sup>435</sup> See Chapter V.

Pulak notes that many of the incised marks on the Uluburun ingots have distinctly maritime themes; these include marks in the shapes of fishhooks, tridents, a fish, possible quarter rudders, and ships.<sup>436</sup> The choice of symbols suggests that the producers of the signs were from a maritime community or had a close association with the sea,<sup>437</sup> but otherwise gives little specific information to their origin. A half of a copper oxhide ingot incised with the 'rudder' sign found on Uluburun copper ingots was recently found in a metal hoard buried in a LM IB (c. 1500 BC) floor of a structure at Mochlos on Crete.<sup>438</sup> This find suggests that this type of incised mark was in use for at least two centuries before the Uluburn ingots were made, and that elements of the marking system used on the Uluburun ingots could predate the invention of the Cypro-Minoan script.

Some marks have a clear function as score or guide marks for breaking or cutting the ingots. Sixteen of the copper oxhide ingots from the Uluburun shipwreck have secondary score marks, probably intended to delineate sections of the ingot to be broken off (Figure 15).

---

<sup>436</sup> Pulak 1998, 194-6.

<sup>437</sup> Pulak 1998, 195.

<sup>438</sup> Whitley 2005, 102-3.

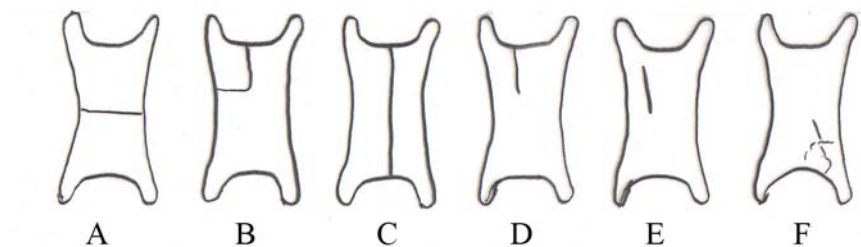

**Figure 15: Score-marks found on the Uluburun copper oxhide ingots. Sixteen examples were counted: seven of Type A, five of Type B, and one each of types C-F. F appears to be a series of irregular chisel marks, perhaps made to break off the corner of the ingot.**

One ovoid ingot (KW 2715), and several oxhide and bun ingots and ingot fragments from Uluburun bear evidence of hammer blows, presumably from attempts to break them (which were not always successful).<sup>439</sup> The score marks bisect the ingots longitudinally, transversely, or frequently isolate one ‘handle’ or ‘ear’ of the ingot. Bass’ statement that pieces of copper oxhide ingots from the Cape Gelidonya wreck “were broken off indiscriminantly as they were needed,” rather than intentionally cut to be standardized fractional units of oxhide ingots is confirmed by finds from other sites as well; corners and halves of copper oxhide ingots that had already been cut or broken off are known not only from the Cape Gelidonya and Uluburun shipwrecks, but are also frequent finds in Late Bronze Age scrap metal hoards.<sup>440</sup> The score marks

<sup>439</sup> Pulak 2000a, 144-5. Copper ingots exhibiting possible damage from hammer blows include KW 2715, an oval-shaped ingot that was broken in half after three to four hammer blows on its mold surface and one blow to its rough surface. Three bun ingots (KW 999, KW 207, KW 402) are similarly damaged. Oxhide ingot fragment L 4032 is considerably bent, probably from the process of breaking the ingot into pieces; this piece joins with five other fragments (collectively labeled KW 147), which all have distortion along their edges. Bun ingot KW 3656, a complete bun ingot, was broken up into five pieces; other bun ingot fragments show similar distortion.

<sup>440</sup> Bass 1967, 52, 71; Knapp 1988; Knapp et al. 1988; Pulak 2000a, 144-5. On the Uluburun ship, ingot fragments KW 771, KW 3495, KW 4393 were similarly cut or broken in antiquity. Two two-handled oxhide ingots from the Uluburun ship, L 743 and L 767 (two fragments of an incomplete ingot) and KW 3102, was bisected and both pieces incised with the same mark, while seven other ingots had a score mark in the area where these ingots were cut; this suggests that the incised marks are ownership marks or mark the origin of the copper, as Bass (1967, 74) has proposed for the primary marks. The corners of two-handled oxhide ingots without ears seem to have also been broken deliberately, as ingot fragments such as L 1181 and L 1184 show.

on the Uluburun ingots are fairly crude, supporting Bass' hypothesis. Copper oxhide ingot halves are known from land sites as well, such as a LM IA-IB deposit from Hagia Triadha.<sup>441</sup> Ingot 'handles' may have served a secondary function as easily removed portions of oxhide ingots. The Ras Ibn Hani oxhide ingot mold provides evidence for another possible function (Figure 16); it has an incised runner or trough leading into one handle, perhaps used as a channel for tapping molten metal into the mold, or else for prying the ingot out of the mold once the metal had cooled.<sup>442</sup>

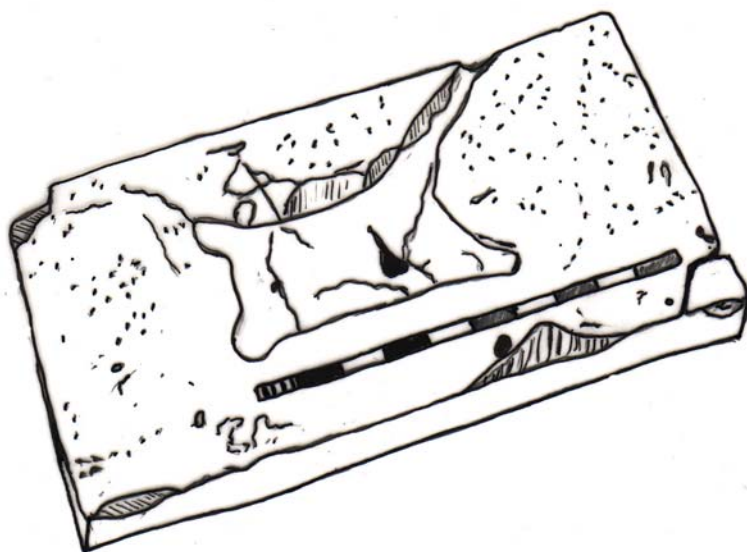

**Figure 16: Limestone oxhide ingot mold from Ras Ibn Hani, Syria (After Gale 1989, 257).**

Perhaps the 'handles' were convenient points by which copper in crucibles could be poured into the ingot mold, or could be tapped directly from a melting furnace.

<sup>441</sup> Bass 1967, 52; Evely 2000, 343; Pulak 1998, 193; 2000a, 152;. The ingot half from Hagia Triadha is unrelated to the earlier deposit of nineteen Type 1 oxhide ingots, which date to the LM IB period (c. 1500-1450 B.C.) (Evely 2000, 343; Buchholz 1959, 34; Muhly 1979, 89).

<sup>442</sup> Craddock et al. 1997, 6; Lagarce 1986, 89.

Breaking the ingots may have also made transport of the metal easier in some situations, helped to divide property in business interactions, and would have facilitated the melting of the metal in preparation for casting copper or bronze.<sup>443</sup> The breaking of copper ingots was probably fairly difficult, however, requiring a reheating of the ingot to make it more friable, a procedure described in detail in Agricola's *De Re Metallica* (1554 A.D.).<sup>444</sup>

Score or chisel marks also appear on sixteen of the approximately 110 tin ingots and ingot fragments on the Uluburun ship.<sup>445</sup> Most of these seem to be stray chisel marks or the remains of scored lines dividing the ingot longitudinally or transversely. The tin cargo was predominantly in ingot fragments, although ten complete tin ingots (three oxhide, five rectangular or slab-shaped, including one in the shape of a stone anchor, and one plano-convex) were recovered.<sup>446</sup> Oxhide ingot quarters or 'ears' and larger pieces of oxhide ingots were the most common form of tin cargo (62, with three

<sup>443</sup> "[A]t the present time, with greatly improved facilities for melting bronze, including an abundance of cheap gas, it is the very common practice to reduce the ingots to fragments because the smaller pieces pack better in the crucible and at the same time the surface directly exposed to the heat is thereby greatly increased" (T. L. Comparette, cited in Bass 1967, 72). Craddock (1995, 168) makes the same point, although in reference to roasting and smelting copper ores. Hammer stones for crushing metal ores are one of the most common objects found at ancient smelting sites in the Mediterranean and elsewhere (Craddock 1995, 37-41). "The obvious advantages of reducing the bulk of the ore to be smelted by the elimination of the barren portions of the ore must have appealed to metallurgists at a very early date" (Hoover 1950, 279).

<sup>444</sup> Tylecote 1987b, 223; Van Lokeren 2000, 275. Agricola (tr. Hoover 1950, 501-4), describes the breaking up of copper 'cakes' both mechanically with an iron-shod stamp (501) or by heating in a large furnace followed by hammering by workmen using a hammer with pointed ends (p. 504). This treatment is reserved for "Those cakes which are too thick to be rapidly broken by blows from the iron-shod stamp." (p. 503). Heat is an important part of the operation: "the hotter the cakes are, the sooner they are broken up; the less hot, the longer it takes, for now and then they bend into the shape of copper basins" (p. 503-4). Similar warping is apparent on some of the Uluburun wreck's plano-convex ingots and ingot fragments (though a flat sledge hammer rather than a pointed one seems to have been used). A Hittite text records similar breaking up of ingots (*supra* n. 355).

<sup>445</sup> The numbers and character of incised marks on the tin ingots and the number of intact tin ingots are based on my examination of photographs from the unpublished preliminary tin ingot catalog; they may therefore be subject to revision.

<sup>446</sup> Pulak 2000a, 149-51.



possible fragments), followed by halves and quarters of slab-shaped ingots (seventeen examples); pieces of plano-convex ingots (three) and ingot fragments of unidentified types (eighteen) made up the rest of the cargo. Since nearly pure tin was used to make these ingots, they are highly ductile, and had to be cut with a hammer and chisel rather than heated and beaten as the copper ingots were.<sup>447</sup> The ductility of tin may also account for the greater thickness of the handles on the tin ingots.

The presence in Late-Bronze-Age hoards of broken fragments of copper oxhide ingots in association with scrap metal is well documented. Finished objects could be cut up and re-melted; examples are known from the Uluburun and Cape Gelidonya shipwrecks as well as from land sites in Cyprus, Greece, Sardinia, and elsewhere.<sup>448</sup> It has also been suggested that scrap metal from broken or discarded copper and bronze objects was sometimes re-melted in the form of oxhide ingots, but this is doubtful in light of the archaeological contexts of most ingot finds as well as the composition and presence of impurities in the ingots themselves.<sup>449</sup> Most Bronze-Age metal hoards contain a large number of worn-out or broken objects and pieces of ingots, while complete oxhide ingots occur much more infrequently.<sup>450</sup> The Uluburun and Cape Gelidonya ships also carried copper and tin ingot fragments in significant quantities, showing that there was no significant bias against the bulk transport of ingot fragments or metal scrap.<sup>451</sup> Although analyses of two of the slab ingots from the Cape Gelidonya wreck have tin contents of approximately 1% and 5%, respectively, these

<sup>447</sup> Pulak 2000a, 152.

<sup>448</sup> Pulak 2001, 13; Catling 1964, 279-98; Bass 1967, 87-8; Stubbings 1979a, 292-6; LoSchiavo 1995, 47.

<sup>449</sup> Hauptmann et al. 2002, 6-7, 13; Muhly et al. 1977, 355-6, 358; Muhly et al. 1980, 92-3; LoSchiavo et al. 1990; Budd et al. 1995a; 1995b; Gale and Stos-Gale 1995; Lichardus et al. 2002, 166, 171-3.

<sup>450</sup> Catling 1964, 279-98; Knapp 1988; Muhly and Maddin 1988; LoSchiavo et al. 1990; Evely 2000, 343-5.

<sup>451</sup> Budd 1995b, 71; Pulak 2000a, 140.

seem to be unusual.<sup>452</sup> The added labor of re-melting scrap into ingot form seems to have been considered unnecessary in most cases, and when it was done, small slab ingots weighing up to one kilogram and perhaps specifically intended as blanks for tool, such as axes or adzes, rather than twenty to thirty kilogram oxhide ingots, were made.<sup>453</sup>

---

<sup>452</sup> Muhly et al. 1977, 358; Bass 1967, 82. An amorphous mass of bronze found at Archanes on Crete may be from remelted scrap; it contained 11.9% tin (Mangou and Ioannou 2000, 211-2). A bun ingot from Mycenae and a slab ingot from Tiryns are also of bronze, with 11% and 17% tin, respectively. These are unusual, however; of fifty-one Bronze Age ingots from Greece and Crete recently studied by Mangou and Ioannou (2000, 210-1, 215-6) these were the only two that contained significant amounts of tin; these have been sourced by lead isotope analysis to Cyprus and Laurion (Mangou and Ioannou 2000, 215).

<sup>453</sup> See Bass 1967, 82 for slab ingot weights.

## CHAPTER IV

### SMELTING TECHNOLOGY AND THE PROCESSING AND SMELTING OF COPPER ORES IN THE BRONZE AGE

The evolution of copper trade in the Late-Bronze-Age Mediterranean cannot be understood without examining evidence for copper sources, alloys used during the Bronze Age, and the metallurgical technology available to Bronze Age peoples. The volume and nature of the metals trade of the Bronze Age was heavily influenced by the available technology for smelting, refining, alloying, and casting bronze; in earlier periods, metal was an exotic commodity used primarily for prestige objects, but by the end of the Bronze Age, tin bronze had become almost a necessity for tools and weapons in addition to retaining the prestige and decorative uses ascribed to metals in earlier periods. The metal-producing capabilities of Bronze-Age societies can be assessed by examining the properties of copper ores and accounts of modern and historical period copper smelting and comparing them to archaeological evidence from Bronze-Age sites and the products of Bronze Age metallurgy. Smelting experiments also provide an important source of information on ancient metallurgical techniques and, indirectly, the capabilities and productive capacity of Bronze-Age metallurgists.

Of the four most common metals worked in the Bronze Age—copper, tin, lead, silver, and gold—copper was the most difficult to process from ore to usable metal. Unlike lead and tin, copper has an extremely high melting point (1083° Celsius), approached only by gold (1063° Celsius); effective casting of molten copper requires temperatures of 1150° Celsius or more, although copper that has been alloyed or contains large

amounts of impurities will have a significantly lower melting point.<sup>454</sup> Unlike gold, which usually occurs in a somewhat pure form in nature, copper, as a less noble metal, is most often found in mineral form and requires smelting and refining to produce a pure metal.

Several major types of copper ores occur in nature. Lumps of native copper, sometimes with purities as high as 99.9%, are found in many regions.<sup>455</sup> Although the exact process by which native copper is formed is poorly understood, native copper is likely formed by copper precipitated from groundwater in the oxidation zone of a copper deposit.<sup>456</sup> Because of its metallic appearance, native copper was almost certainly the first form of copper to be noticed by prehistoric peoples, and it was likely the first type of copper used to make objects. Native copper can be cold-worked at temperatures far below its melting point, and was used to make objects in the Old World as early as the eighth or ninth millennium B.C. and by prehistoric cultures in the Americas, some with no other metallurgical technology.<sup>457</sup> Although it is found in large amounts in a few areas of the world (such as the Great Lakes region of North America), it commonly occurs in amounts too small to produce objects of any significant size.<sup>458</sup> The relative lack of native copper in the Old World in comparison to North America could be due to its extensive exploitation in metallurgy over the millennia; fewer indigenous cultures in North America used copper, and they did not use it at the scale seen in Europe, Africa, and Asia for objects such as tools and weapons.<sup>459</sup>

---

<sup>454</sup> Tylecote 1986a, 16; Evely 2000, 325, 328.

<sup>455</sup> Wayman 1989, 3; Tylecote 1986a, 5-6.

<sup>456</sup> Tylecote 1986a, 5.

<sup>457</sup> Wayman 1989, 3; Bradley and Childs 1991, 15-6.

<sup>458</sup> Wayman 1989, 3-4.

<sup>459</sup> Wayman and Duke 1999, 55.

Copper ores are far more common in the earth's crust than native copper; however, unlike native copper, a true smelting technology is required to extract usable copper from these ores.<sup>460</sup> Copper smelting methods seem to have been developed some time in the fifth millennium B.C. and spread to other regions or was independently invented in different areas over the next two thousand years, as sites in Iran and the Balkans show; these sites have provided evidence of mining and copper processing such as crucibles, tuyeres, molds, and slag.<sup>461</sup>

There are several main types of copper ores. Primary sulfide ores are formed in the earth's crust along fault lines along hydrothermal vents, where seawater heated by contact with molten magma was discharged; this seawater contained dissolved metals (particularly iron, copper, manganese, zinc, and lead), which were deposited around the vents.<sup>462</sup> Copper sulfide and chalcopyrite ores, which contain a combination of copper sulfide and iron pyrites, are the main copper ores formed by this process.<sup>463</sup> The deposits available for exploitation in human history were lifted from the seafloor by tectonic action until they are exposed on dry land; such formations are known as ophiolites, the most famous in the eastern Mediterranean being the Troodos Ophiolite Complex on Cyprus.<sup>464</sup> Over time, copper sulfide and chalcopyrite ores exposed by tectonic action and erosion are weathered into new minerals, including copper oxides,

---

<sup>460</sup> Muhly 1973a, 171; Wayman 1989.

<sup>461</sup> Muhly 1985a, 116-8; Muhly 1973a, 171; Jovanović 1980, 31-7; 1985, 117-23; 1988; Tylecote 1986a, 10; Gale et al. 2003.

<sup>462</sup> Stos-Gale and Gale 1994, 93; Constantinou 1982, 13-5, 17; 1992, 52-3.

<sup>463</sup> Constantinou 1992, 54; Stos-Gale 1994, 93.

<sup>464</sup> Constantinou 1992, 52-3.

carbonates, and sulphates, all of which have been exploited for copper at some point in antiquity.<sup>465</sup>

Carbonate ores, such as malachite and azurite are highly pure-- up to 90% of the copper present in the ore may be recovered in a smelt-- and produce little or no slag when smelted.<sup>466</sup> Malachite may be smelted at 700-800° C, a relatively low temperature in comparison to the temperatures required to smelt other types of copper ore.<sup>467</sup> Unfortunately, these characteristics which make these ores good for smelting also makes their use difficult to detect in the archaeological record. Carbonate ores were likely the first copper ores to be smelted. The vivid green color of malachite and blue color of azurite would have made them highly recognizable to prehistoric peoples and highly desirable for aesthetic purposes.<sup>468</sup> Copper minerals from the Feinan region of Jordan, a major copper deposit in the Near East, were collected in the Pre-pottery Neolithic period for the manufacture of beads and powder possibly used for cosmetic purposes; similar uses for copper carbonate minerals seem to have occurred around the fifth millennium B.C. copper mine of Ai Bunar in Bulgaria.<sup>469</sup> Experiments have shown that malachite can be smelted in an open charcoal fire using a crucible smelting process, which suggests the possibility that copper smelting may have been accidentally invented when malachite was introduced to an open fire.<sup>470</sup> The crushing

<sup>465</sup> Constantinou 1992, 57.

<sup>466</sup> Zwicker et al. 1985, 104; Maddin 1988, 172; Gale and Stos-Gale 1996, 367; Craddock 1995, 126-7; Gale et al. 1996, 375. Malachite is reduced to copper metal by the burning of charcoal to carbon monoxide in an atmosphere without an excess of oxygen:  $2C + O_2 \rightarrow 2CO$ ; the carbon monoxide produced in this reaction combines with the malachite (copper carbonate) to produce pure copper and carbon dioxide ( $CO + CuCO_3 \rightarrow 2CO_2 + Cu$  (Tylecote 1962, 25). If too much oxygen is present, much of the carbon dioxide will combust to produce carbon dioxide, and the copper carbonate will not be reduced:  $2CO + O_2 \rightarrow 2CO_2$  (Tylecote 1962, 25).

<sup>467</sup> Coghlan 1971, 49-65; Tylecote 1962, 25.

<sup>468</sup> Constantinou 1992, 54-5.

<sup>469</sup> Hauptmann et al. 1992, 5; Gale et al. 1996, 368.

<sup>470</sup> A pure copper carbonate such as malachite can be reduced to copper at a temperature of around 7-800° Celsius, while an open campfire can attain temperatures of up to 700° Celsius. Malachite inserted

of copper ores into powder for pigments or cosmetics may have also contributed to an accidental discovery of smelting. Metal ores must first be crushed in preparation for smelting. This allows them to more easily fuse into cakes, heat up and melt more easily; impurities (gangue) are also removed in this way, allowing the smelters to increase the amount of metal in the smelting charge.<sup>471</sup> Ore was customarily broken up into pea-sized particles or into fine powder in a process known as beneficiation; some traditional copper smelters in India have been observed mixing the powder into cakes of animal dung.<sup>472</sup> Hammer stones for the crushing of ores are one of the most common artifacts found on ancient mining and smelting sites throughout the world, and beneficiation debris from early ore processing has been identified on several prehistoric sites.<sup>473</sup> Waste material from working copper ores into stone objects or pigments are far more likely to be reduced to pure copper in the conditions described in Coghlan's experiment than larger pieces of ore.

In the formation of copper deposits, copper oxide minerals form over time as exposed sulfide minerals are weathered; these will form a colorful 'iron hats' or gossans, bright red or yellow deposits which would have been easily recognized by ancient prospectors.<sup>474</sup> Both oxide and carbonate minerals are also formed near the surface of a copper deposit, making them far easier to discover and exploit than sulfide ores; as a result of geological formation processes, these ore types were probably the first to be smelted by prehistoric peoples.<sup>475</sup> As a result, these minerals are often too scarce at

---

on a "flat pottery dish, with an upturned porous pot over it" was reduced to copper (Tylecote 1986a, 16-7).

<sup>471</sup> Craddock 1995, 156, 161, 169; Hoover 1950, 273.

<sup>472</sup> Craddock 1995, 161.

<sup>473</sup> Craddock 1995, 37-41, 187; Hoover 1950, 279; Forbes, 1966, 7:223-4; Given and Knapp 2003, 67.

<sup>474</sup> Coghlan 1975, 21; Constantinou 1982, 17; Wertime 1980, 12; Stos-Gale and Gale 1994, 94.

<sup>475</sup> Coghlan 1975, 21.

major ore deposits to be economically significant today. However, Stos-Gale and Gale and Tylecote point out that quantities of these minerals exist at many modern mines on Cyprus which were exploited in antiquity; while these deposits may be uneconomical or insignificant by the standards of modern mining technology, they may have been a major source of copper ores in the smaller-scale production of ancient times.<sup>476</sup>

Copper-oxide ores are also comparatively easy to smelt, needing a reducing atmosphere, or oxygen-poor environment, to separate the copper metal from the gangue.<sup>477</sup> In order for both a sufficiently high temperature for melting slag and metal, and a sufficiently reducing atmosphere to be produced, a reducing fuel must be used in the smelting furnace; in the ancient world, this was charcoal.<sup>478</sup> When burned, charcoal produces carbon monoxide gas, which also creates a reducing atmosphere; in addition, the main impurity produced by charcoal burning is ash, which is a flux and therefore desirable.<sup>479</sup> Charcoal is almost pure carbon, an element that aids in the removal of oxides from the ore; the carbon combines with the oxygen in the copper oxide and is released as a gas.<sup>480</sup> When heated to a sufficient temperature, the impurities in the ore which do not sublime into gases form a slag, which, being less dense than the molten copper, can be easily skimmed off the molten ore if it is heated

---

<sup>476</sup> Stos-Gale and Gale 1994, 96-6; Tylecote 1982a, 81, 99.

<sup>477</sup> Muhly 1973a, 171-2; Horne 1982, 8; Rapp 1999, 701; Harding 2000, 215.

<sup>478</sup> Horne 1982, 8. While charcoal was the most suitable fuel for smelting available in the Bronze Age, two other options could have also been available. Coal was occasionally used in classical times, but coal contains large amounts of impurities such as sulfur and phosphorus, which can produce a poor-quality end product, although the Chinese utilized coal low in sulfur as early as the fourth century A.D. (Craddock 1995, 189, 196). Coal was not commonly used for metallurgical activities in the western world until the process of coking was invented in the 17th century, which removes these impurities (Horne 1982, 8). Coal was therefore not likely to have been used for metallurgical operations in the Bronze Age, even where it was available. Wood burns at a lower temperature than charcoal (it has half of charcoal's caloric value) so charcoal was a more efficient fuel for metallurgical activities (Horne 1982, 9, 11). Dung mixed with charcoal could have also been used for metallurgy; this combination has been recorded in ethnographic accounts of traditional copper smelting in India (Craddock 1995, 196).

<sup>479</sup> Harding 2000, 217; Muhly 1973a, 171. See also n. 454.

<sup>480</sup> Horne 1982, 8.



to a sufficient temperature for a period of time.<sup>481</sup> Like carbonate ores, copper oxides are very noticeable due to their bright colors; oxide minerals in the gossans such as hematite were used as red pigments long before they were sought for smelting purposes.<sup>482</sup>

In some copper deposits on Cyprus, the percolation of water through copper deposits below the gossan and oxidized zone of minerals often forms areas of copper sulfate minerals and sometimes lumps of pure copper; these processes, occur in the 'cementation zone', or 'zone of secondary enrichment.'<sup>483</sup> Some of these ore bodies, such as those on Cyprus, are often sandy and friable, can easily be excavated by hand, or with wood, antler, or stone tools.<sup>484</sup> Carbonate ores are formed in this way, and other ores formed by this process are also easy to smelt; experiments have shown that the copper sulfate mineral chrysocolla can be smelted in a crucible without producing any slag.<sup>485</sup> While it is known that sulfate ores were exploited on Cyprus in the Roman period and later for copper salts used for medicinal purposes (as described in a well-known account by the Roman physician Galen), the role of these deposits in Bronze Age mining on Cyprus is debated; Koucky and Steinberg have argued that these deposits were extremely important sources of metal even before the Roman period.<sup>486</sup>

Below the weathered copper ore deposits are massive sulfide ore veins. These ores usually consist of compounds of copper, iron, and sulfur, which require additional

---

<sup>481</sup> Muhly 1973a, 171.

<sup>482</sup> Wertime et al. 1980, 10; Peltenburg 1982, 54.

<sup>483</sup> Coghlan 1975, 21; Constantinou 1982, 17.

<sup>484</sup> Constantinou 1982, 17.

<sup>485</sup> Koucky and Steinberg 1982a, 163; Gale et al. 1996, 368.

<sup>486</sup> Koucky and Steinberg 1982a, 175.

steps to process into copper metal.<sup>487</sup> Most of the sulfur in these ores must be removed in order to produce a good quality metal; an excess of sulfur will cause the metal to be very brittle.<sup>488</sup> Sulfide ores require roasting (heating in an oxidizing atmosphere) before they are smelted, in order to remove impurities that adversely affect the quality of the metal, particularly sulfur, arsenic, and antimony.<sup>489</sup> Roasting consisted of calcinating the ore by lighting fires on ore collected in piles in open areas, in roasting pens (such as those illustrated by Agricola), or by producing an oxidizing or oxygen-rich atmosphere in furnaces.<sup>490</sup> The ore is heated to around 600 degrees Celsius in the oxidizing atmosphere of an open fire in order to produce a copper oxide. Under these conditions, the copper oxide then reacts with the sulfur to form foul-smelling sulfur dioxide gas, which is released into the atmosphere.<sup>491</sup> This process could take from several days to up to a month; however, since the chemical reaction is exothermic, it takes relatively little fuel to maintain once it has begun.<sup>492</sup> The roasting process would take some experience to perfect; if the roasting pile reaches too high a temperature, the copper will sinter and oxidize, making it much more difficult to remove the copper from the ore.<sup>493</sup> Often this process was incomplete, since the cores of ore nodules were not exposed to the oxidizing atmosphere of the fire and would therefore retain sulfur as an impurity.<sup>494</sup> Some ore nodules would need to be roasted repeatedly; Agricola

---

<sup>487</sup> Coghlan 1975, 20.

<sup>488</sup> Rapp 1989, 110; Forbes 1964, 9:18.

<sup>489</sup> Forbes 1964, 9:18; Coghlan 1975, 27-8. Other impurities which cause the copper to be brittle, such as copper oxides, need to be removed in a reducing atmosphere; this can be accomplished in a smelting or melting furnace fueled by charcoal (Forbes 1964, 9: 18, 20).

<sup>490</sup> Forbes 1964, 9:18; Hoover 1950, 278, 349-51.

<sup>491</sup> Muhly 1973a, 171; Charles 1980, 164; Tylecote 1982a, 99.

<sup>492</sup> Koucky and Steinberg 1982a, 165; Hoover 1950, 273-5, 278-9.

<sup>493</sup> Koucky and Steinberg 1982a, 165.

<sup>494</sup> Maddin et al. 1983, 132, 134, 136-7; Tylecote 1982a, 87, 99.

mentions different types of copper ore being roasted from once up to seven or nine times.<sup>495</sup>

‘False gossans’, or oxidized piles of waste material from beneficiation or roasting, have been identified in archaeological deposits on Cyprus; charcoal and ancient pottery and other artifacts in these formations have proven that they are in fact manmade and not natural features.<sup>496</sup> Deposits which are probably spoil heaps from ore beneficiation and roasting have been identified at Agropia *Kriadhis* in northern Cyprus; these range in date from the Geometric to Classical periods, based on collected pottery.<sup>497</sup> The remains of these processes can be identified by the presence of layers of small rock fragments not containing any metal and by furnace conglomerate probably related to roasting processes; these consist of fragments of ore loosely bonded to charcoal fragments showing the effects of heat at temperatures lower than those achieved in smelting furnaces.<sup>498</sup>

For copper sulfide ores, impurities in the ore must also be removed; these keep the copper metal from agglomerating if they have no new compounds with which to react. This can be accomplished by introducing a flux into the furnace during the smelting process, if such material is not naturally present in the ore.<sup>499</sup> Fluxes are materials that combine with gangue material in the ore to produce a slag; often fluxes help to lower the melting point of an ore during a smelt as well.<sup>500</sup> The necessary flux depends on the composition of the ore. The most common slag produced from copper smelting is

---

<sup>495</sup> Muhly 1973a, 171-2; Hoover 1950, 351.

<sup>496</sup> Given and Knapp 2003, 67.

<sup>497</sup> Given and Knapp 2003, 69, 219-20; Wertime 1982, 355-9.

<sup>498</sup> Given and Knapp 2003, 219.

<sup>499</sup> Muhly 1973a, 172.

<sup>500</sup> Tylecote 1987a, 107-8.

fayalite or iron silicate slag ( $2\text{FeO}\cdot\text{SiO}_2$ ), which has a conveniently low melting point in the range of 1120-1170° Celsius.<sup>501</sup> If the gangue in the ore is silica, then iron must be added, while if it is iron then silica or manganese (which produces a more fluid slag) must be added. In some cases the inert material is lime (CaO) or magnesia (MgO), in which case both iron and silica must be added.<sup>502</sup> Some ores, such as the copper-manganese ores in the Feinan region of Jordan, are self-fluxing; the Feinan ores were being exploited by the Early Bronze Age.<sup>503</sup> The proper fluxes for a particular ore were probably found through experimentation.<sup>504</sup>

While some scholars believe that Bronze-Age smelters used no deliberate fluxes, fluxes such as sand or crushed quartz and iron minerals were readily available, sometimes within the actual ores being smelted (some ores are self-fluxing, containing enough sand, iron, and/or lime to produce a fluid slag in which the copper will not dissolve).<sup>505</sup> Manganese was probably used by the Roman period as a deliberate flux, as shown by analyses of slag from Cyprus. Manganese does not occur in great quantities in copper ores on the island or in analyzed pre-Roman period slags from copper slags, but it does occur in large amounts in Roman period slags.<sup>506</sup> The use of this ore also contributed to low iron contents in the smelted copper.<sup>507</sup> Iron was probably used as a flux in smelting operations at Timna from the Chalcolithic to the New Kingdom period; iron oxides were readily available in the local copper oxide

<sup>501</sup> Tylecote 1987a, 107.

<sup>502</sup> Tylecote 1987a, 108.

<sup>503</sup> Hauptmann et al. 1992, 7; Tylecote 1987a, 108.

<sup>504</sup> Gale et al. 1996, 380-1.

<sup>505</sup> Tylecote 1987a, 108.

<sup>506</sup> Given and Knapp 2003, 71, 91-2, 102, 104, 137-8. Manganese does occur in slag from a MBA crucible excavated at *Ambelikou-Aletri*; it may have been added as a deliberate flux, in the form of manganese oxide (MnO) (see Zwicker 1982, 64).

<sup>507</sup> Hauptmann et al. 1992, 29.

ores.<sup>508</sup> Since iron is a major constituent of the local ores, its effects as a flux may have been discovered accidentally and systematically employed only through a process of trial and error.<sup>509</sup> The Uluburun oxhide ingots contain localized areas of iron that are magnetic, although these are more likely accidental inclusions of iron-rich slag than deliberately added fluxes.<sup>510</sup>

The most common copper ore on Cyprus and the most difficult to process is chalcopyrite ( $\text{CuFeS}_2$ ), from which both the iron and sulfur must be removed. To process chalcopyrite ore, first the crushed ore, which is a mix of chalcopyrite and iron pyrite, must be roasted to remove sulfur as sulfur dioxide and to convert as much of the iron sulfides to oxides as possible (these could then be removed by slagging in the smelting furnace):

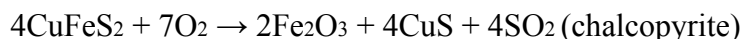

At each stage of refining, sulfur reacts with oxygen in the air, forming sulfur dioxide, which escapes as a gas and leaves blowholes in the remaining product; this would continue until almost all sulfur is removed.<sup>512</sup> The roasted material, consisting of some unchanged ore and copper sulfides, were then smelted in a furnace with a limited air supply (a reducing atmosphere); this is the *matting* stage.<sup>513</sup> The desired product of this stage is *matte*, a mixture of copper sulfide and iron sulfides:

<sup>508</sup> Rothenberg 1972, 232; Rothenberg and Glass 1992, 143. Some copper ore deposits in the Feinan area of southern Jordan contain highly pure copper carbonate ores (chrysocolla, with 36-45% Cu) interspersed with black manganese oxides and copper silicates. This type of ore was self-fluxing, and exploited as early as the Early Bronze Age period to smelt at least an estimated 100 tons of copper.

<sup>509</sup> Tylecote and Boydell 1978, 29-31.

<sup>510</sup> Hauptmann et al. 2002, 13.

<sup>511</sup> Craddock 1995, 149.

<sup>512</sup> Muhly 1973a, 172.

<sup>513</sup> Craddock 1995, 149.



Sand or crushed quartz is added as a flux to combine with iron oxides in the ore to form an iron silicate slag, which is tapped off or otherwise removed.<sup>514</sup> Typically copper matte was broken up after cooling, roasted to convert the sulphides into oxides:

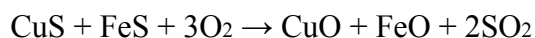

After this step the copper oxides produced were then smelted into blister or black copper, which would be further refined by remelting to remove any remaining impurities:<sup>515</sup>

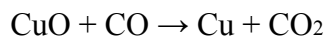

The details of the refining process would depend on a number of factors, including the exact composition and impurities in the copper ore, the efficiency of the smelting process and smelting installation used, and the skill and experience of the smelter.<sup>516</sup> Many complex variations of this process were developed in different parts of the world to deal with the processing of local copper ores.<sup>517</sup>

Koucky and Steinberg (1982a, 165-6, 168-9) believe that a process called exposure, in which copper ore is stacked in piles and allowed to weather for several months, was widely used in ancient times instead of roasting. While this process has the advantage of being far less labor- and resource-intensive than roasting and some evidence exists for its use in later periods, the use of the roasting process is thought by many scholars to be more likely.<sup>518</sup> Roasting is arguably an easier process for smelters of oxide and carbonate ores to discover than exposure, and a more advanced knowledge of

<sup>514</sup> Craddock 1995, 149; Tylecote 1987a, 107-8.

<sup>515</sup> Craddock 1995, 150; Forbes 1964, 9:19; Tylecote 1982a, 94; Evely 2000, 328.

<sup>516</sup> Forbes 1964, 9:19, 21.

<sup>517</sup> Craddock 1995, 150-3; Hoover 1950, for a 16th century account of variations in copper smelting processes.

<sup>518</sup> Tylecote 1982a, 89; Knapp 1990, 136; Muhly 1991, 183-4.

chemistry seems to be necessary to understand and control the process in an efficient and economically viable manner.<sup>519</sup> Roasting would also take less time than exposure, particularly if abundant fuel sources were available, which seems to have been the case on Cyprus at least into the Roman period.<sup>520</sup>

The furnace conditions required to remove various impurities are different for different impurities, however. For example, residual sulfur, arsenic, nickel, cobalt, and other elements are removed by combining with oxygen in an oxidizing atmosphere; the blowing of oxygen over molten metal forms “dross” on the surface of the copper, which can then be removed. This process is performed until cuprite appears, which occurs when all impurities have been oxidized.<sup>521</sup> Cuprite inclusions are typically reduced by the poling process, in which the copper is stirred with poles or twigs of green wood; this process causes oxygen dissolved in the mixture to be released from the copper through combustion (as the wood burns), and therefore increase the copper’s purity.<sup>522</sup> The stirring helps to release copper oxide trapped in the molten copper and evolves hydrocarbon gases as it catches fire, which will reduce the oxygen content of the copper.<sup>523</sup> It is not known whether poling was practiced in the Bronze Age, however, although Forbes believes that poling was “well within the means of the ancient metallurgist” and “from our finds it is obvious that all these operations were properly controlled before 2000 B.C.”<sup>524</sup> In the case of the Uluburun ingots, at least, in

<sup>519</sup> Constantinou (1982, 22) notes significant difficulties in regulating the exposure process, which modern mining companies on Cyprus have experienced.

<sup>520</sup> Koucky and Steinberg 1982a, 165-6, 168-9; supra n. 12; Constantinou 1982, 22. Analyses of Bronze Age copper slags from Hala Sultan Tekke and Kition contain copper prills and copper sulfides, indicating a matting process was used to oxidize the ore; slag analyzed from the Kalavasos slag heap on Cyprus also contained a mineral indicating the probable use of a matting process (Tylecote 1982a, 87-9; Knapp et al. 1999, 137; Given and Knapp 2003, 216).

<sup>521</sup> Hauptmann et al. 2002, 18; Muhly 1973a, 172.

<sup>522</sup> Forbes 1964, 9:20, 40-2.

<sup>523</sup> Forbes 1964, 9: 20-1, 40, 42; Tylecote 1987a, 194-5; Craddock 1995, 204.

<sup>524</sup> Forbes 1964, 9:42.

which cuprite is present along with sulfide and slag inclusions, such conscious refining may not have been practiced.<sup>525</sup>

### *Fuel for Metallurgical Processes*

Metal production required huge amounts of charcoal. Modern experimenters have found that smelting copper usually requires at least 7-10 hours of heating.<sup>526</sup> Wood could be used for the roasting process and for the mining technique of fire-setting, in which fire was used as a method to break up ore-bearing rock into manageable pieces. But the smelting process required the use of charcoal as a fuel since no other fuel commonly used in ancient times would burn hot enough to smelt copper.<sup>527</sup> Charcoal production also requires a significant expenditure of labor. Wood and perhaps sod would need to be cut and perhaps dried for up to several months, then used to construct a charcoal stack, which was lighted and left to smolder for up to a week before being dismantled.<sup>528</sup> Charcoal is produced by burning wood in a reducing atmosphere, usually a covered pit, in some cases lined with stones to keep earth from mixing with the charcoal, or a timber stack which is covered with earth or clay.<sup>529</sup> The charcoal stack would have a small flue and perhaps a few smaller ventilation holes to allow some circulation during the burning.<sup>530</sup> Hardwoods were preferred for metallurgical uses according to ethnographic accounts and premodern metallurgical texts; hardwoods contain more carbon and are stronger and more durable.<sup>531</sup> Theophrastus lists charcoal from different tree species as being particularly suited to

<sup>525</sup> Hauptmann et al. 2002, 18; Mangou and Ioannou 2000, 213-4.

<sup>526</sup> Merkel 1990, 86-7; Tylecote et al. 1977, 307; Bamberger et al. 1986, 1169.

<sup>527</sup> Craddock 1995, 193; however, see Fasnacht 1999, 182, who asserts that wood can burn hot enough for some metallurgical processes.

<sup>528</sup> Horne 1982, 11; Craddock 1995, 191.

<sup>529</sup> Craddock 1995, 191-2; Smith and Gnudi 1966, 177-8.

<sup>530</sup> Craddock 1995, 192; Smith and Gnudi 1966, 178.

<sup>531</sup> Craddock 1995, 192; Horne 1982, 9-10.



specific tasks; he writes that pine wood was used to smelt silver, while smiths use fir.<sup>532</sup> Typically local hardwoods were used; these could be obtained from local trees such as acacias, used as fuel at Timna in the Sinai and in ancient Israel, or the Persian oak, tamarisk, and wild almond trees used by charcoal burners in modern Iran.<sup>533</sup> Desert shrubs could also be used for producing charcoal.<sup>534</sup> In early modern Europe wood for charcoal came from coppices grown and managed specifically for that purpose; these were cut into poles of about 10-15 cm in diameter and left to dry for several months before being burned.<sup>535</sup> Ancient writers mention similar arrangements for charcoal burning in classical times.<sup>536</sup> After the fire in the charcoal stack was allowed to burn down and cool (which usually took several days), the charcoal would be removed and possibly sieved to remove charcoal dust (known as *finés*), which could impede the flow of gases during a smelt.<sup>537</sup>

Several estimates have been made of the amounts of fuel required to produce smelted copper. These estimates vary widely, and would likely depend on the type and purity of ore smelted, the design of the smelting furnace, the type and amount of flux or fluxes used, the amount of preparation of the ore in the form of beneficiation and roasting, and the skill of the smelters involved. It is clear from all estimates that large amounts of wood were required to fuel even a small, local metallurgical industry. Only about 10-20% of the wood used in a charcoal stack becomes charcoal, and large

---

<sup>532</sup> “But different kinds of charcoal are used for different purposes: for some uses men require it to be soft, thus in iron mines they use that which is made of sweet-chestnut when the iron has been already smelted, and in silver-mines they use charcoal of pine-wood: and these kinds are also used by the crafts. Smiths require charcoal of fir rather than of oak: it is indeed not so strong, but it blows up better into a flame, as it is less apt to smoulder: and the flame from these woods is fiercer” (Cited Forbes 1966, 6:22).

<sup>533</sup> Craddock 1995, 195; Horne 1982, 9-10, 13; Bamberger et al. 1986, 2.

<sup>534</sup> Horne 1982, 9-10.

<sup>535</sup> Craddock 1995, 192.

<sup>536</sup> Forbes 1966, 6:21-2.

<sup>537</sup> Craddock 1995, 192.

amounts of charcoal is required to make a significant amount of copper using ancient techniques.<sup>538</sup>

Table 2. Estimates of Ore and Fuel Required to Smelt Copper Sulfide Ore Using

Premodern Techniques					
Amount of ore to be smelted:	Amount of wood required to produce charcoal for roasting/smelting:	Amount of charcoal required for roasting/smelting:	Amount of copper produced:	Amount of slag produced:	Source(s):
---	---	Four million tons of charcoal used to produce approx. four million tons of ancient slag on Cyprus	---	---	Bachmann 1982; Wertime 1982, 357
26 kg copper oxide ore from Timna; 64 kg fluxes, + 35 kg “wall material (90% SiO <sub>2</sub> )”	---	244 kg	2.05 kg + 5.07 kg copper-rich “dispersed material”	125.1 kg	Bamberger et al. 1986, 1169 (smelting experiment)

<sup>538</sup> Craddock 1995, 193.

<b>TABLE 2, continued</b>					
<b>Amount of ore to be smelted:</b>	<b>Amount of wood required to produce charcoal for roasting/smelting:</b>	<b>Amount of charcoal required for roasting/smelting:</b>	<b>Amount of copper produced:</b>	<b>Amount of slag produced:</b>	<b>Source(s):</b>
Ore to fuel ratio of 1: 2	---	244 kg for all stages of smelting process (Timna ore)	2 kg (122 kg charcoal/kg of copper)	---	Bamberger et al. 1986, 3, 1170
---	12-20 cubic meters of wood (for one ton of charcoal)	300 kg	1 kg (from copper sulfide ores)	---	Constantinou 1982, 22
---	700 kg	100 kg	5 kg	---	Horne 1982, 12
---	---	60 kg	Approx. 2 kg of "impure copper" containing 10-25% iron	Approx. 30 kg	Merkel 1983, 174, 178
7 kg copper ore (half 'simulation ore'); 27 kg hematite flux	---	77 kg	4.1 kg	25.9 kg	Merkel 1990, 87; Craddock 1995, 193
1,000 kg of Cypriot [sulfide] copper ore	---	Six tons	30 kg [approximately one oxhide ingot]	---	Stech 1982, 116
"50 donkey loads of raw materials"	---	---	10 kg	---	Stech 1985, 103; Wiener 1990, 148

<b>TABLE 2, continued</b>					
<b>Amount of ore to be smelted:</b>	<b>Amount of wood required to produce charcoal for roasting/smelting:</b>	<b>Amount of charcoal required for roasting/smelting:</b>	<b>Amount of copper produced:</b>	<b>Amount of slag produced:</b>	<b>Source(s):</b>
---	---	“...as much as 600 kg of charcoal per smelt”	30 kg of copper (one oxhide ingot)	300 kg of slag (“as much as 10 times the metal weight [produced]”)	Tylecote 1977, 316
---	---	40 kg	1 kg	---	Tylecote 1980, 188
1 kg of Cypriot copper ore	---	620 kg	---	---	Wertime 1982, 357

Fuel procurement and use in metallurgical activities would obviously have a major environmental impact on metal-producing regions, including deforestation, soil erosion, and the destruction of habitats for many plant and animal species.<sup>539</sup> Metal production in some areas, such as parts of Israel and southern Spain, may have been curtailed or halted during certain periods in antiquity due to a lack of fuel.<sup>540</sup> Similarly, iron smelting in Siegetland, Germany, was limited to only three months of the year in early modern times in order to limit deforestation.<sup>541</sup> Some have suggested the possibility that 'managed woodlands' or practices such as coppicing (or the cutting and drying of young trees into poles used in charcoal stacks), which causes little or no long-term deforestation, occurred during the Bronze Age, although evidence for such

<sup>539</sup> Craddock 1995, 194.

<sup>540</sup> Craddock 1995, 194; Jovanović 1980, 37; Home 1982, 13.

<sup>541</sup> Weisgerber 1982, 28.

practices would be difficult to find.<sup>542</sup> Wertime (1982) suggests that hardwood trees in Cyprus, particularly the golden oak, which can be easily coppiced from its roots, were cultivated for this purpose in ancient times.<sup>543</sup> Both Pliny and Theophrastus wrote that young trees produce better charcoal.<sup>544</sup>

Although the effects of human activity on the ancient Mediterranean environment are not completely understood, the long-term environmental impact of the copper industry was likely enormous. It is likely that significant damage to the natural environment on the island of Cyprus was a result of the combination of deforestation and grazing, particularly by goats, which in turn led to large-scale erosion, a significant problem on the island today.<sup>545</sup> Constantinou (1982; 1992) estimates that the island of Cyprus must have been deforested up to sixteen times in a 3,500 year period in order to produce the charcoal required to make the estimated four million tons of ancient slag (waste products from an estimated 200,000 tons of copper metal) known on the island.<sup>546</sup> Although Constantinou writes that the island's "socioeconomic development for thousands of years was based entirely on a sustained and reckless attack by man on the forests," he estimates that the forests of the Troodos were capable of regenerating within 80-100 years.<sup>547</sup> However, Meiggs believes that the impact of mining and metallurgy on forests may be exaggerated.<sup>548</sup> Historical accounts by Strabo and others present Cyprus as rich in timber in ancient times.<sup>549</sup>

---

<sup>542</sup> Craddock 1995, 194.

<sup>543</sup> Wertime 1982, 352, 357; Forbes 1966, 6:21-2.

<sup>544</sup> Forbes 1966, 6:21-2.

<sup>545</sup> Burnet 2004, 120-2; Wells 2001, 126, 131-2, 135-6; Given and Knapp 2003, 178.

<sup>546</sup> Constantinou 1982, 22-3; 1992, 69-71.

<sup>547</sup> Muhly 1996, 46; Constantinou 1982, 22-3; 1992, 72.

<sup>548</sup> Meiggs 1982, 380.

<sup>549</sup> Strabo (*Geography*, 14. 6. 4-6: 383) quotes the third-century B.C. author Eratosthenes in writing that the two main exports of the island are copper minerals and timber. The island was densely forested in his time: "Eratosthenes says that in ancient times the plains were thickly overgrown with forests..."

More recent studies, such as Burnet's survey of the environmental impact of human activity on the Makheras and Adelphi forests in central Cyprus, calls Constantinou's estimate into question. Burnet notes that several major hardwood species on the island coppice easily, and that Cypriot forests have regenerated in many areas despite extensive environmental degradation in the 19th and 20th centuries due to human activities.<sup>550</sup> She also believes that woodland management of some kind was practiced early in the Iron Age.<sup>551</sup> This idea is at least tentatively supported by the extensive evidence for ancient terraces and check dams in the Cypriot landscape; the management of water and soil resources has occurred on the island since the Roman period and possibly earlier.<sup>552</sup> Available water supplies on the island are also due mainly to preservation of the forest; the forest canopy cools the ground sufficiently after rain so that significant water reserves end up in streams and rivers rather than evaporating.<sup>553</sup> Red pine (*Pinus brutia*) charcoal is known from at least one slag heap on Cyprus dating to the Roman period, although hardwoods seem to have been the preferred fuel.<sup>554</sup> *Pinus brutia*, cypress, and other species were also utilized as supports for mining tunnels.<sup>555</sup>

The extent of damage done during the Bronze Age was probably insignificant in comparison to later periods. Pollen studies of the Late Bronze-Age levels of Kition

---

and [therefore] not cultivated; that the mines helped a little against this, since the people would cut down the trees to burn the copper and the silver, and that the building of the fleets further helped... but that, because they could not thus prevail over the growth of the timber, they permitted anyone who wished, or was able, to cut out the timber and to keep the land thus cleared as his own property and exempt from taxes" (Cited Wertime 1982, 355).

<sup>550</sup> Burnet 2004, 30-1, 35, 106, 119, 121.

<sup>551</sup> Burnet 2004, 35.

<sup>552</sup> Given and Knapp 2003, 132.

<sup>553</sup> Burnet 2004, 24, 41.

<sup>554</sup> Burnet 2004, 35.

<sup>555</sup> Given and Knapp 2003, 177; Bruce 1937, 650.

indicate that some fluctuations in pollen types had occurred, possibly as a result of human activity such as felling hardwood trees, but that large-scale deforestation had not yet taken place.<sup>556</sup> Tree pollen was common, though there was a preponderance of pine pollen and a decrease in hardwood species, which may have been preferentially selected for charcoal production.<sup>557</sup> This may indicate “a high level of human impact and extensive forest disturbance”; *Pinus brutia* in particular regenerates and colonizes deforested areas more quickly than other tree species on the island.<sup>558</sup> Burnet proposes a process on Cyprus by which mixed forests gradually became more dominated by *Pinus brutia* as hardwoods were used up for fuel. In this scenario, human activity does not cause the wholesale destruction that has been proposed by earlier scholars, yet it significantly alters the natural environment.<sup>559</sup> Burnet’s results show some similarities to Marshall *et. al.*’s study of the environmental impact of copper smelting in Austria, where copper reserves had also been exploited since the Bronze Age.<sup>560</sup> Their findings suggest a decrease in hardwood pollen, particularly pollen from the genus *Fagus* (beech), but overall there was “no wholesale woodland clearance.”<sup>561</sup> This decrease correlates with the period of increased industrial activity, and according to historical records, beech was preferred for smelting.<sup>562</sup> Similar conclusions were reached by a study on Bronze Age mine sites in the British Isles. Despite some evidence for the preferential use of certain wood species on mine sites (preserved in the form of charcoal), pollen cores from two mining areas in Wales and Ireland indicate only small decreases in tree pollen during known periods of mining.<sup>563</sup>

---

<sup>556</sup> Burnet 2004, 120.

<sup>557</sup> Burnet 2004, 86.

<sup>558</sup> Burnet 2004, 86.

<sup>559</sup> Burnet 2004, 121; Muhly 1996, 46.

<sup>560</sup> Marshall *et al.* 1999, 255.

<sup>561</sup> Marshall *et al.* 1999, 258, 260.

<sup>562</sup> Marshall *et al.* 1999, 258, 260.

<sup>563</sup> Mighall 2003, 44.

Mining, smelting, and other industrial processes may also affect vegetation by changing the chemical composition of soil. Studies of soil changes due to industrial smelting have also had varied results; while soil in areas of the Harz mountains in Germany were found to have a decreased phytotoxicity in deposits after 7-800 years, and smelting sites in Zaire seem to have had little long-term effect on vegetation, some smelting sites from the north Italian Bronze Age still show a lack of vegetation after three thousand years.<sup>564</sup> Higher copper concentrations in peat dating to the period of second millennium B.C. copper mining at Copa Hill, a mine site in Wales, and Mount Gabriel, a mine site in Ireland, may have been the result of atmospheric pollution, although the environmental impact of this mining activity, if any, remains unclear.<sup>565</sup> Further environmental studies are needed to determine the extent of environmental change or degradation that occurred due to mining and smelting activities.

#### *Bronze Age Evidence for Smelting Technology*

Copper smelting requires the construction of a furnace to trap enough heat to melt the copper ore and separate the metal from other impurities. Copper ore was typically melted in an insulated bowl-shaped or cylindrical furnace, either freestanding or dug into the ground (Figure 17).<sup>566</sup>

---

<sup>564</sup> Given and Knapp 2003, 19-20.

<sup>565</sup> Mighall 2003, 47-50.

<sup>566</sup> Tylecote 1987a, 109-11.



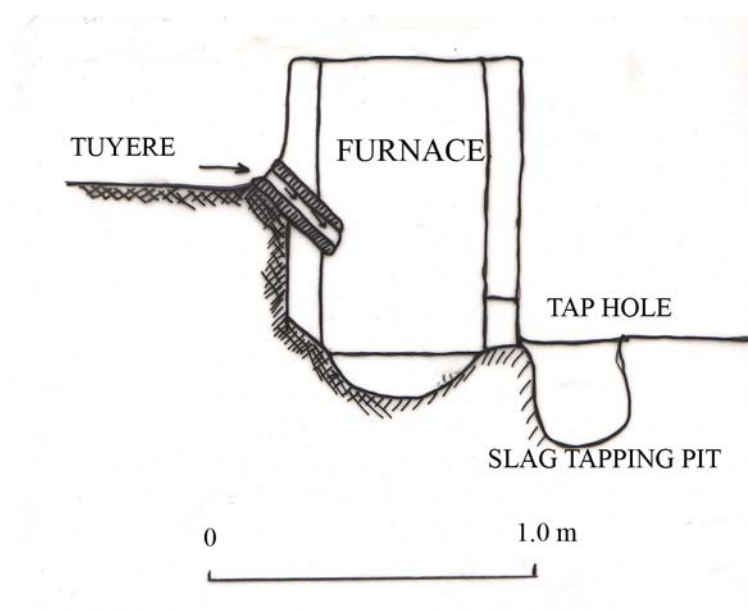

**Figure 17: Reconstruction of a Late Bronze Age slag-tapping furnace from Kition, based on archaeological remains (After Tylecote 1982a, 91).**

During the smelting process, slag rises to the top of the furnace, while the copper sinks to the bottom, due to its greater density. In some furnaces, a tap hole is built into the furnace so that the slag can be drained out and separated from the copper.<sup>567</sup> The earliest use of slag tapping is debated, but it seems to have been fairly common by the Late Bronze and Early Iron Ages at Timna; isolated examples from the Early Bronze Age are known from the same region.<sup>568</sup> Tap slag, or slag drained from a furnace into a tapping pit, produces a characteristic 'ropy' pattern when it cools; this has been found only in some LBA Cypriot slag, and has appeared at New Kingdom sites at Timna.<sup>569</sup>

In early smelting, however, the temperatures or conditions to fully separate the slag from the copper were usually not reached; this was usually due to lower furnace

<sup>567</sup> Tylecote 1987a, 109-10.

<sup>568</sup> Rothenberg 1978, 2; 1990, 8-55.

<sup>569</sup> Rothenberg 1990, 44; Muhly 1989, 307.

temperatures resulting from poor insulation and other factors, or by an unfavorable ratio between flux (either natural, such as iron in the ore, or deliberately added) and gangue, the non-metallic material in the ore.<sup>570</sup> As a result, small masses of copper called ‘prills’ precipitated out of a relatively viscous slag; both the copper and slag were allowed to cool together inside the furnace, after which the slag cake was broken up with hammerstones to remove the prills of pure copper.<sup>571</sup> Such slags are also characterized by a lower extraction rate of copper, and tend to be easy to recognize due to the fact that they have been broken up into small pieces.<sup>572</sup> Although this was a relatively inefficient method of copper extraction, it was still used at times in later periods, such as New Kingdom period sites at Timna.<sup>573</sup>

By the Late Bronze Age, slag tapping and full separation between gangue and copper metal during smelts were becoming more common. At Politiko *Phorades* on Cyprus, the slag and copper were probably tapped together into a single pit adjacent to the furnace, but more complete separation of slag and copper matte were achieved, probably due to better furnaces and smelting procedures. This method resulted in ‘plano-convex’ slag cakes with depressions on their bottoms where a fully-formed copper matte cake was removed (Figure 18).<sup>574</sup>

---

<sup>570</sup> Tylecote 1987a, 110; Rothenberg 1978, 9-11; Giardino 2002, 25.

<sup>571</sup> Muhly 1989, 304.

<sup>572</sup> Rothenberg 1978, 9; Bachmann 1978, 21-2.

<sup>573</sup> Rothenberg 1978, 9-11; 1990, 7-9, 63-5.

<sup>574</sup> Given and Knapp 2003, 217; Knapp et al. 1999, 137.

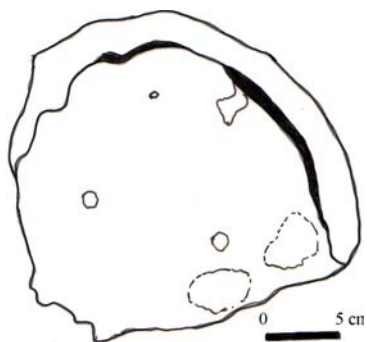

**Figure 18: Slag cake from the smelting site of Politiko *Phorades* in Cyprus, showing the impression left by a thorough separation of slag and (in this case) copper matte (After Given and Knapp 2003, 216).**

The use of this method in other regions and time periods is still debated, although at least one instance of slag tapping is known from the Early Bronze Age, and tap slags are well attested by the Late Bronze Age at Apliki in northwest Cyprus and on Egyptian smelting sites in the Sinai dating to the 14<sup>th</sup>-12th centuries B.C.<sup>575</sup> At Timna, ring-shaped slag formations have been discovered from New Kingdom smelting operations; it seems that the slag was tapped from the furnace into a ring-shaped pit and removed with a pole when it was partially cooled into a solid cake.<sup>576</sup> ‘Ropy slag’, characterized by ridges in the slag, were formed by leaving a slag tap-hole open to let slag flow out continuously.<sup>577</sup> These slag pieces may vary in thickness and shape, depending on whether they were tapped into a pit or directly onto the ground.<sup>578</sup> After the smelt, the furnace was frequently torn down to retrieve the copper and the fragments of the furnace's walls were typically reused to build another furnace.<sup>579</sup> As a result, intact Bronze Age furnace remains are uncommon.

<sup>575</sup> Rothenberg 1978, 14, n. 13, 15, n. 43; 1990, 8, 24, 26, 34-6, 41-5; Muhly 1989, 306-9.

<sup>576</sup> Rothenberg 1990, 45.

<sup>577</sup> Merkel 1983, 175; Rothenberg 1990, 44.

<sup>578</sup> Koucky and Steinberg 1982b, 118.

<sup>579</sup> Rothenberg 1990, 66-7; Belgiorno 2000, 8. However, Evidence from the Iron Age copper smelting site of Ayia Varvara-*Almyras* on Cyprus, however, shows that smelting furnaces were sometimes used

Furnace construction varied in the Chalcolithic and Bronze Age, but the walls of the smelting furnace are typically made with a clay furnace lining and a combination of stones and clay in the body of the furnace (as outlined in Table 3). Other excavated furnaces, such as an early Late Bronze Age (c. 1700-1500 B.C.) furnace from the site of Politiko *Phorades* on Cyprus, were made entirely of clay.<sup>580</sup> Materials such as charcoal and sand could also be added to clay lacking such inclusions to make it more refractory, as with clays used to make crucibles.<sup>581</sup> The earliest and simplest furnaces seem to have been bowl-shaped depressions in the ground, possibly lined with clay.<sup>582</sup> Crucible smelting may have also been widespread at an early date, but due to the limited capacity of crucibles it was more likely used in later periods for refining copper and producing finished objects than for smelting ore.<sup>583</sup> The sizes of copper smelting furnaces seem to have been remarkably similar throughout the Bronze and early Iron Age; excavated furnaces tend to be 30-45 cm in diameter, and although the original height of furnaces are almost never preserved, height estimates range from 0.7 to 1.0 m.<sup>584</sup>

---

up to five times; in these cases repairs were made after smelts, but completely demolishing the furnace was unnecessary (Fasnacht 1989, 63; 1999; 181).

<sup>580</sup> Knapp et al. 1999, 139.

<sup>581</sup> Merkel 1983, 175.

<sup>582</sup> Rothenberg 1990, 5-8.

<sup>583</sup> Zwicker 1982, 63-4; Tylecote 1971, 55-6; 1987a, 107-9.

<sup>584</sup> See Table 3 for bibliographical sources.

Table 3. Dimensions and Construction Materials of Excavated Bronze Age Metallurgical Furnaces

Site/Date:	Furnace Diameter:	Furnace Height (actual or estimated):	Materials and Construction Details:	Evidence for Forced Draught:	Sources:
Atheniou (Cyprus; Late Cypriot, c. 1300-1150 B.C.)	30-40 cm in diameter ? (based on impressions on the bottoms of furnace conglomerates)	?	?	?	Dothan and Ben-Tor 1983, 139; <i>Maddin et. al.</i> 1983, 134.
Chrysokamino (Crete, EM I-III)	20-45 cm in diameter	?	Fragments of tapering clay cylinders, "perforated with many holes" and with "open tops and flat bases", possibly shaft furnace remains	Fragments of a "minimum of ten pot bellows"	Betancourt <i>et. al.</i> 1999, 354, 356, 358-9, 362, Fig. 6: 1-2.
Enkomi (Cyprus; Late Cypriot )	'Crucible' or furnace lining, 30-40 cm in diameter		Non-tapping (?) furnace lining built into the ground. Made of refractory clay; slagged from use. Capacity: approx. 17 liters	One tuyere? (Tylecote 1971, 53: "There is a slot in the side which could be where the tuyere entered the lining.")	Dikaios 1969:3a, Pl. 159, n.20; Tylecote 1971, 53-5; 1981, 107; 1982a, 92; Stech 1982, 105-6
Enkomi (Late Cypriot)	25-30 cm diameter (estimate based on fragment of furnace slag)	---	---	---	Late Cypriot? (Found "near the entrance outside of the excavation") <i>Zwicker et. al.</i> 1977, 310.

<b>TABLE 3, continued</b>					
<b>Site/Date:</b>	<b>Furnace Diameter:</b>	<b>Furnace Height (actual or estimated):</b>	<b>Materials and Construction Details:</b>	<b>Evidence for Forced Draught:</b>	<b>Sources:</b>
Kition, Area I, 'Furnace A' (Cyprus, 13 <sup>th</sup> century B.C.)	70 cm wide	92 cm deep	Pit cut into ground for non-tapping furnace; ash, slag, burnt bone in immediate area. Possibly used for crucible refining of copper or melting of bronze.	Possible use of 'elbow' tuyere.	Stech 1982, 108; Stech et al. 1985, 388-93; Tylecote 1971, 53-4.
Politiko <i>Phorades</i> (Cyprus; Late Bronze Age, c. 1700-1500 B.C.)	42-44 cm outside diameter (Given <i>et. al.</i> 1999, 32)	?	Cylindrical furnace with a flat base, either free-standing or in a pit; Furnace lining made of "coarse refractory clay" with organic material and gossan inclusions; (Kassianidou 1999, 94, 96; Knapp 2003, 563)	50 nearly complete tuyeres, 600 tuyere fragments (including one 'elbow' and four 'double' tuyeres). Possible use of leather bag bellows (Knapp <i>et. al.</i> 1999, 141).	Knapp 2003, 561-2; Knapp et al. 2002, 320.
Timna Site 39 (c. 3500-3000 B.C.)	45 cm in diameter (originally 20-30 cm?)	40-50 cm deep bowl furnace; original height unknown (estimated 40-50 cm) (Rothenberg 1990, 4-5)	Pit furnace, with stone superstructure	one possible tuyere (probably clay applied to a bellows/blowpipe nozzle)	Rothenberg 1990, 3-8, 67; Bamberger <i>et. al.</i> 1986, 1168.
Timna Sites 30, 185, Site 2 (Layer II, New Kingdom: 13 <sup>th</sup> -mid-12 <sup>th</sup> c. B.C.)	30-40 cm in diameter	?	Clay- or clay- or mortar-lined bowl furnaces, some with stone and sand superstructures; one rock-cut furnace at Site 2 (14 <sup>th</sup> c. B.C.)	Small clay tuyeres; probable use of one or more pot bellows	Rothenberg 1990, 8-12, 14, 16-39.

**TABLE 3, continued**

<b>Site/Date:</b>	<b>Furnace Diameter:</b>	<b>Furnace Height (actual or estimated):</b>	<b>Materials and Construction Details:</b>	<b>Evidence for Forced Draught:</b>	<b>Sources:</b>
Timna Site 2. Layer I (Sinai; Early Iron Age, 10 <sup>th</sup> -8 <sup>th</sup> c. B.C.)	0.3 m in diameter	0.7-1.0 m (40 cm underground, 20-30 cm above ground)	Slag-tempered clay furnace linings and/or freestanding furnaces (5-10 cm thick)	“maximum of three” tuyeres proposed (Rothenberg 1990, 49); probable use of pot bellows	Merkel 1983, 173; Rothenberg 1990, 44-54.

Although the first metallurgical furnaces probably used a natural draught-- some seem to have been located in windy hilltops for this purpose-- methods of forced draught were eventually developed to increase temperatures inside furnaces.<sup>585</sup> Blowpipes, probably of wood, copper, or cane and capped with clay tuyeres, were an early development; they are known from Egyptian tomb paintings from the third millennium B.C.<sup>586</sup> By using up to eight to twelve individuals with blowpipes to provide a forced draught, some experimenters have been able to smelt small amounts of copper in crucibles as well as melt gold and other metals.<sup>587</sup> Pot bellows constructed from clay and stone were used during the Bronze Age throughout the eastern Mediterranean and Middle East by the second millennium B.C. (Figure 19); bellows of organic materials, such as leather and animal stomachs, were likely in use at an early period as well.<sup>588</sup> Leather bellows are likely shown in Old Kingdom Egyptian reliefs as well as in an

<sup>585</sup> Betancourt et al. 1999, 363, 367; Smith and Gnudi 1966, 293-4; Ventris and Chadwick 1973, 509; Rothenberg and Glass 1992, 143.

<sup>586</sup> Tylecote 1981, 108-11.

<sup>587</sup> Tylecote 1981, 108, 110-1.

<sup>588</sup> Craddock 1995, 180-1; Davey 1979; Tylecote 1981; Nibbi 1987, 32-9.

Egyptian tomb painting from Beni Hasan depicting itinerant smiths with a probable set of leather bellows on the back of a donkey.<sup>589</sup>

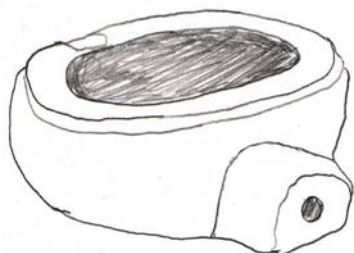

**Figure 19: Ceramic pot bellows from the Old Babylonian site of Tel edh-Dhiba'i, near modern Baghdad. Similar pot bellows were in use throughout Egypt and the eastern Mediterranean by the second millennium BC (After Davey 1988, 65).**

One or more clay tubes or tuyeres were required to supply air to the furnace as nozzles to the bellows or blowpipes. At least three types of tuyeres have been discovered from LBA contexts on Cyprus.<sup>590</sup> The most common are 'straight' or 'D'-shaped tuyeres, which are simple tubes made of refractory clay (Figure 20). Their size varies, as does the inside diameter of the tube (typically about 1-2 cm, although twelve unusually large tuyeres with 4 cm diameter bores are known from Apliki).<sup>591</sup>

<sup>589</sup> Nibbi 1987, 32-3.

<sup>590</sup> Muhly 1989, 304-5, 308-9.

<sup>591</sup> Muhly 1989, 307; 1991, 183; Tylecote 1981, 111, 116.



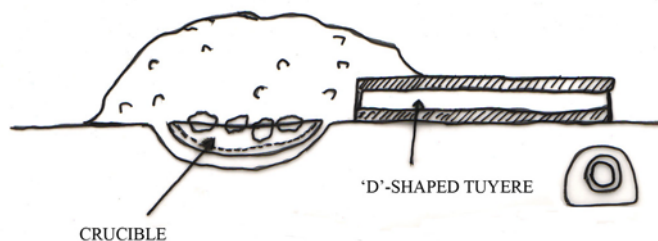

**Figure 20: Reconstruction of crucible smelting using a 'D'-shaped tuyere, based on archaeological remains from the Middle Cypriot site of Ambelikou-*Aletri* (After Tylecote 1982a, 93).**

'Bent' or 'elbow' tuyeres are less common, but are known from Enkomi, Kition, Apliki, Timna, Qantir/Piramesse in the Nile Delta, and Bronze Age sites in Eastern Europe.<sup>592</sup>

The positions of these tuyeres in the furnace are unknown, although a number of plausible reconstructions have been made. Some tuyeres from New Kingdom furnaces at Timna show slagging on part of their surface, probably the part exposed in the interior of the furnace.<sup>593</sup> This slagging shows that these tuyeres were pointed downward at angles ranging from 25-50°.<sup>594</sup> This is consistent with Tylecote's (1971; 1978) reconstructions of Bronze Age smelting furnaces.<sup>595</sup> One type of tuyere found at the New Kingdom (c. 1330-1245 B.C.) site of Qantir in the Nile Delta seems to have been deliberately designed to direct a forced draught downwards at about 50 degrees; it resembles a straight tuyere except the end is blocked and a small hole is pierced in the side of the tuyere near the blocked end (Figure 21a-b).<sup>596</sup>

<sup>592</sup> Tylecote 1981, 110-1; Muhly 1989, 309; Pusch 1990, 86-8.

<sup>593</sup> Rothenberg 1990, 35.

<sup>594</sup> Rothenberg 1990, 36-7.

<sup>595</sup> Tylecote 1971, 54.

<sup>596</sup> Pusch 1990, 87, 113.

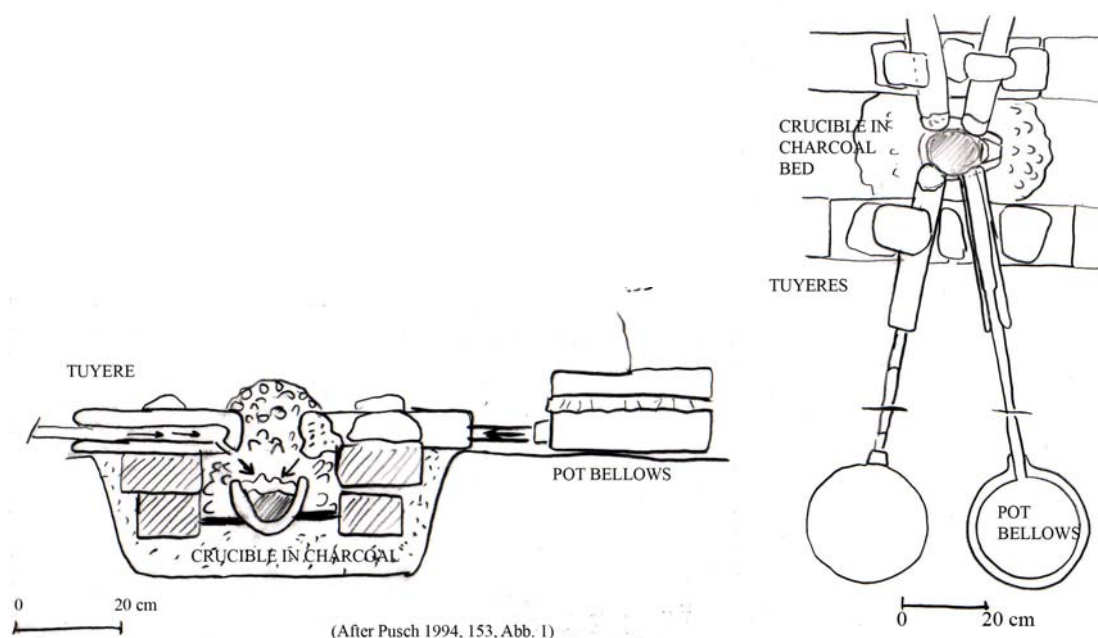

**Figure 21a-b: Crucible furnace with unusual tuyeres from Qantir in the Nile Delta, 13th century B.C. (After Pusch 1994, Abb. 1).**

Furnaces pictured in Egyptian tomb paintings with pairs of pot bellows could be connected to a single tuyere, thus supplying a continuous forced draft from one direction, or a pair of tuyeres could protrude from a single pot bellows; several arrangements are known from ethnographic studies of copper smelting and from archaeological evidence from Bronze Age sites (Figure 22).<sup>597</sup>

<sup>597</sup> Tylecote 1981, 108, 113; 1987a, 121-3.

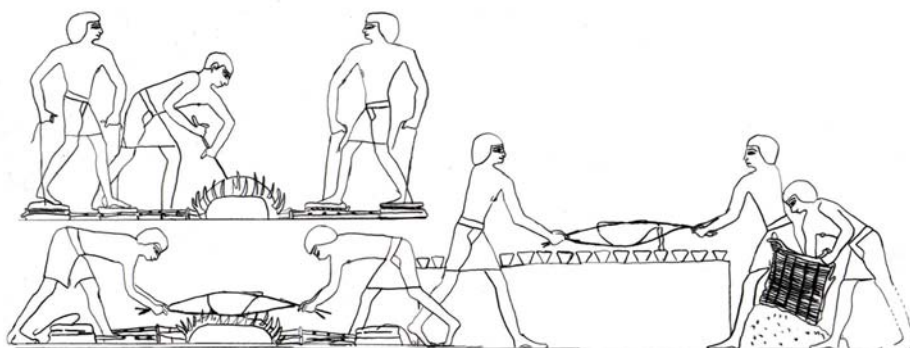

**Figure 22: Melting copper and casting bronze doors using pot bellows, crucible or buried furnaces, and crucibles. From the Tomb of Rekhmire, mid-15th century B.C. (After Davies 1973, Pl. LII).**

The tuyeres themselves vary in construction, often depending on their function, but are typically made either of baked or sun-dried clay or of refractory clay with large inclusions of sand, grit, slag, or organic materials in order to better resist the heat involved in metallurgical operations.<sup>598</sup> The simplest ancient tuyere known, from a Chalcolithic smelting site in the Sinai, appears to have been made of unfired clay placed around the edge of a blowpipe or bellows nozzle.<sup>599</sup> Some tuyeres from Timna seem to have been made with alternating layers of clay and reeds, presumably to make them survive as long as possible; other examples show evidence of attempts to repair damage which occurred during smelts.<sup>600</sup> Iron-rich slag can also react with clay in furnace linings, causing significant damage, as modern experimenters have

<sup>598</sup> Rothenberg 1990, 36; Tylecote 1981, 111, 114-5; 1987a, 115.

<sup>599</sup> Rothenberg 1990, 8-9.

<sup>600</sup> Rothenberg 1990, 36, 41. Tylecote (1981, 114-5, 118) proposes that smithing tuyeres were typically designed to last as long as possible, and cites decorated tuyeres from eastern European Bronze Age as supporting evidence; however, this was not always the case with smelting tuyeres, which were not always prefired. Nonetheless, tuyeres could probably be salvaged from demolished furnaces and reused until destroyed, so the construction of reusable tuyeres was likely a priority for most ancient smelters.

discovered.<sup>601</sup> Such slagging probably encouraged ancient metallurgists to adopt the practice of demolishing furnaces after one use.

---

<sup>601</sup> Bamberger et al. 1986, 1170; Merkel 1990, 97.

## CHAPTER V

### COPPER AND TIN SOURCES IN THE MEDITERRANEAN REGION DURING THE BRONZE AGE

It is unlikely that there are major undiscovered copper sources in the Mediterranean that were exploited in ancient times, although modern opencast mining may have obliterated most or all traces of ancient exploitation in many mining areas.<sup>602</sup> Ancient mining sites are often difficult to date due their relative lack of pottery and other datable material and the use of very similar tools and techniques through long periods of history. Ancient miners and metallurgist likely used small ore deposits at times, some of which may have been exhausted in antiquity or gone unnoticed in modern times.<sup>603</sup> This may be particularly true of placer deposits of tin and gold. In such deposits, the metal or metal ore is weathered from the host bedrock and deposited in small particles in streambeds; these deposits can theoretically be exhausted over time by panning or vanning, processes that leave far fewer archaeological traces than mining operations.<sup>604</sup> Any list of ore deposits proven to have been exploited in ancient times is therefore likely to be incomplete. However, many copper sources that are not economically viable by today's standards or had been exhausted in ancient times may

---

<sup>602</sup> Rapp 1999, 701.

<sup>603</sup> Yener and Vandiver 1993a, 212; Branigan 1974, 59; 1982, 206-7; De Jesus 1978, 98, 101.

<sup>604</sup> Maddin et al. 1977, 38; Muhly 1985c, 277-8. 'Vanning' is similar to panning, in which the heavier gold or tin ore particles are sifted and separated in a small amount of water from the lighter gangue (quartz sand and other minerals); in 'vanning', a shovel is used rather than a pan (Penhallurick 1986, 165)

have played an important role in prehistoric metallurgy, particularly during its early stages.<sup>605</sup>

Metal deposits exist in many parts of the eastern Mediterranean. Significant metal deposits are known in Anatolia, including copper, gold, silver, iron, lead, as well as small amounts of tin; in this region copper sources were exploited at a significant scale by around 3000 B.C., and tin bronze also came into use in the early second millennium.<sup>606</sup> Large metal deposits known to have been exploited in the Bronze Age exist in the **Taurus Mountains** of south-central Anatolia and the **Ergani Maden** mining area of eastern Turkey; however, the history of metal exploitation in ancient Anatolia is extremely complex and in many ways still poorly understood.<sup>607</sup> Anatolian metallurgical activity likely had a profound influence on the early metallurgy of both the Middle East and the Mediterranean region; copper objects from sites in Anatolia are some of the earliest known, and even predate many of those from Mesopotamia.<sup>608</sup> Evidence of copper mining in Anatolia, particularly in the **Kozlu** mining area in the Pontic region of Turkey, is some of the earliest known; radiocarbon-dated mineshaft supports from the EBA site of **Horoztepe** date back to the mid-fifth millennium B.C.<sup>609</sup> The earliest copper artifacts-- pins and beads-- were coldworked from native copper lumps.<sup>610</sup> These come from the late eighth millennium B.C. site of Çayönü Tepesi in

<sup>605</sup> Yener and Vandiver 1993a, 212.

<sup>606</sup> Shepherd 1993, 219, 221-2; Kaptan 1995, 197; De Jesus 1978.

<sup>607</sup> Yener 2000, 19-21; De Jesus 1978; Muhly 1985a; 1985c, 283-5; Kaptan 1986; 1995; Gale et al. 1996, 367; Rapp 1999, 710; Pulak 2001, 24-5 Sayre et al. 2001.

<sup>608</sup> Muhly 1988, 5-8; 1999, 15.

<sup>609</sup> This evidence is roughly contemporary with early evidence for copper mining in the Balkans (Muhly 1987, 101-2).

<sup>610</sup> Cierny and Weisgerber 2003, 23. Coldworking involves heating copper metal in an open flame to a high temperature (between 500-700° Celsius), which is nonetheless well below its melting point. At this temperature, the metal is forged using a hammer and anvil. This treatment increases the softness and malleability of the metal and, when cooled, will make the worked areas of the metal harder,

Anatolia; smelted copper, gold, lead, silver (cupellated from the lead ore galena) and antimony were also in use in Anatolia by the sixth millennium B.C.<sup>611</sup> Smelted metal began to appear in c. 5000 B.C., again in Anatolia.<sup>612</sup> At Arslantepe in eastern Anatolia, arsenical copper was in use by at least the late fourth millennium B.C.<sup>613</sup> Arsenical copper technology may have later been exported from Anatolia to other areas such as the Levant and Cyprus.<sup>614</sup>

Arsenical copper was invented or introduced in Palestine by the mid-fourth millennium B.C., became the dominant alloy in use in the Early Bronze Age and remained in use in the Near East and eastern Mediterranean well into the second millennium, perhaps due in part to the relative scarcity of tin. It was likely invented accidentally, perhaps in several different areas independently.<sup>615</sup> The sophistication of this early copperworking technology in this region is exemplified by a hoard of several hundred objects found in the ‘Cave of the Treasure’ at Nahal Mishmar in Israel. The hoard probably dates to the second quarter of the fourth millennium BC.<sup>616</sup> This hoard included copper and copper alloy tools, 240 copper mace heads, and a large number of intricate ceremonial objects cast using the lost-wax technique.<sup>617</sup> Some of the objects contain a high arsenic content (up to 11.9%), which suggests the possibility that these are early attempts at the deliberate production of copper alloys.<sup>618</sup>

---

though excessive working will make the object brittle (Lucas and Harris 1999, 213).

<sup>611</sup> Cierny and Weisgerber 2003, 23; Muhly 1988, 5-7; Piggott 1999, 3.

<sup>612</sup> Muhly 1988, 7.

<sup>613</sup> Muhly 1999, 16.

<sup>614</sup> Muhly 1999, 16.

<sup>615</sup> Muhly 1999, 16; Stos-Gale et al. 1986, 25; Piggott 1999, 3.

<sup>616</sup> Moorey 1988a, 173.

<sup>617</sup> Bar-Adon 1980, 24-133; Moorey 1988a, 174-82.

<sup>618</sup> Bar-Adon 1980, 201; Wheeler and Maddin 1980, 106.

Mesopotamia also played an important role in the early dissemination of metals and metallurgical technology, probably learning metallurgical techniques from cultures in Iran and Anatolia.<sup>619</sup> The first metal objects appear in Iran in the seventh millennium B.C.; Mesopotamia was not an early innovator in metallurgy in comparison to Anatolia and Iran, but became a major consumer of copper from Oman, Iran, and Anatolia, as well as importing other metals, and was a significant producer of finished metal goods by the late third millennium B.C.<sup>620</sup>

Southeastern Europe may have also played a significant role in the development of copper metallurgy in the Mediterranean. Chalcolithic mines were discovered at Rudna Glavna, and possibly at Rudnik and Jarmovac in Serbia, as well as at Ai Bunar in Bulgaria. Large amounts of copper carbonate and oxide minerals were extracted and processed for the indigenous metal industry from these sites at an early date; Ai Bunar is the oldest known copper mine in Europe.<sup>621</sup> At Rudna Glavna, over forty pits, the results of open-cast mining, have been identified; these were dug using antler and stone picks and firesetting.<sup>622</sup> Gold, copper, and bronze metallurgy developed early in Bulgaria, particularly at Varna; copper artifacts appear at many fifth millennium B.C. sites in this region.<sup>623</sup> Copper deposits existed in the Levant as well; an advanced copper metallurgy industry operated there by c. 3500 B.C.<sup>624</sup> Recently a large metal workshop dating to the Early Bronze Age (c. 3600-2000 B.C.) has been excavated at Khirbat Hamra Ifdan in the copper-rich Feinan district of southern Jordan; finds include furnace remains, metallurgical equipment such as molds and crucible

<sup>619</sup> Moorey 1988b, 28-9.

<sup>620</sup> Moorey 1988b, 29-32.

<sup>621</sup> Muhly 1999, 15; Jovanović 1988, 69, 77; Gale et al. 2003; Maggi and Pearce 2004, 74.

<sup>622</sup> Jovanović 1988, 70-1.

<sup>623</sup> Glumac and Todd 1991, 9.

<sup>624</sup> Muhly 1973a, 214-6.



fragments, slags, copper prills, crescent-shaped copper ingots and the clay molds used to cast them, and finished copper objects.<sup>625</sup> The Feinan deposits were exploited extensively, though intermittently, over eight millennia. This activity led to the deposition of an estimated 150,000-200,000 tons of slag in slag heaps near the ore deposits.<sup>626</sup> Smelting activity in the region appears to have peaked in the third and first millennia B.C. and during the second through fourth centuries A.D.<sup>627</sup> The smaller copper deposits of the Arabah region of the Negev desert were exploited intermittently from the Chalcolithic into the first millennium B.C. and later; sites in the region are perhaps the most extensively studied metallurgical sites in the eastern Mediterranean.<sup>628</sup> The Arabah deposits were intermittently exploited on a small scale since the Chalcolithic, and Egyptians more intensively exploited them for a time in the Late Bronze Age (14th to mid-12th century B.C.).<sup>629</sup> The Egyptians exploited a variety

<sup>625</sup> Levy et al. 2002, 425, 430.

<sup>626</sup> Hauptmann et al. 1992, 3.

<sup>627</sup> Hauptmann et al. 1992, 5.

<sup>628</sup> Rothenberg 1972; 1978; 1988; 1990; Merkel 1983; 1986a; 1990; Bamberger et al. 1986, Rothenberg and Glass 1992; Hauptmann et al. 1992.

<sup>629</sup> Rothenberg 1972, 14, 229-230. Egyptian finds throughout Sinai indicate extensive involvement (with some significant chronological gaps) in exploiting mineral resources in the Sinai. Based on inscriptions in the mining areas of Magharah and Serabit el Khadim, Old and Middle Kingdom mining expeditions seem to have been concerned primarily with turquoise; the inscriptions make several references to turquoise but mention copper only once (Lucas and Harris 1999, 202-3). An account in the tomb of Khnumhotep, an official who lived during the reign of Middle Kingdom pharaoh Amenemhat II, mentions large amounts of copper acquired in mining expeditions, some of which may have been acquired in an expedition to the "turquoise terraces" (identified by Shaw as the turquoise-mining regions of the south-central Sinai) (Shaw 1998, 249-50). Petrie noted slag and other evidence for copper smelting in an Old/Middle Kingdom mining camp at Magharah, and a crucible in the temple at Serabit el Khadim (Petrie 1906, 51-2, 162). Both of these sites contain both turquoise and copper ore deposits, although the relative importance of the copper deposits at these sites is debated (little copper remains today) (Lucas and Harris 1999, 202-5). Ancient mining galleries are known in the region, but these show no evidence of exploitation specifically by Egyptians (Lucas and Harris 1999, 204-5). The situation is further complicated by the fact that Egyptians procured malachite, a copper mineral found in the Sinai, since the Badarian period, for use as a cosmetic eye-paint, pigment, and coloring for glazes and glass; however, it could also be smelted into copper metal (Lucas and Harris 1999, 202, 210-2). Both turquoise chips and "small copper nodules" were found in recent excavations at a late Old Kingdom Egyptian fortified camp at Tell Ras Budran, in south-central Sinai on the Gulf of Suez (Mumford 2006, 33, 37, 50). These finds suggest that both turquoise and copper were processed at the site, perhaps inside the fortified enclosure; in one part of the camp a concentration of ash and copper nodules was found (Mumford 2006, 37, 41, 54). The lack of slag at the site suggests that beneficiation

of other copper sources (especially during the Old Kingdom period), such as copper deposits in Egypt's Eastern Desert and Nubia, and imported copper as well.<sup>630</sup>

Although Crete lacks any major copper deposits, it seems to have played an important role in the early interregional trade in metals. Some of the earliest examples of sophisticated copper and gold metallurgy from the eastern Mediterranean originate in Early Minoan Crete.<sup>631</sup> Branigan (1968; 1974) believes that the early copper and bronze objects from the island were likely made with local copper in the Early Bronze Age and imported copper in later periods.<sup>632</sup> By the Late Minoan period, a large, thriving metallurgical industry had developed on the island, based on imported copper and tin and administered by the Cretan palatial system. Finds of foundry equipment, scrap hoards, oxhide ingots, and bronze artifacts in Minoan settlements and tombs

---

and sorting of ore may have occurred in the fort; the ore could then have been shipped elsewhere, perhaps to an area where fuel and water was more readily available. The transportation of ore from desert mines to sites with more abundant natural resources has been suggested by researchers studying early copper production in this area (Hauptmann et al. 1992, 7; Yekutieli et al. 2005, 17, 19). Many scholars now agree that copper mining occurred alongside turquoise mining from the Old Kingdom period onwards (see Hestrin and Tadmor, 1963; 287; Shaw 1998, 247; Lucas and Harris 1999, 208-9; Mumford and Parcak 2003, 85-92; and Mumford 2006, 52) agree that Egyptian copper mining occurred in the Sinai in this period; Hestrin and Tadmor (1963, 287) and Muhly (1980a, 31), suggest that Egyptian inscriptions recorded only expeditions run by high officials in search of costly materials such as gold, turquoise, and amethyst and not copper mining expeditions, which were deemed unimportant. When Egyptians began exploiting copper from south Sinai is unknown, but several authors (Ogden 2000, 149; 50; Mumford suggests that it began as early as the EB I period, when Egyptian artifacts begin to be found in the area and when copper from the Feinan region of Jordan begins to appear within Egypt, (Ogden 2000, 149-50; Mumford and Parcak 2003, 87-92). Egyptian involvement in the region increased in the Old Kingdom period; texts record period of intensified mining and resulting conflict with indigenous populations occurred during Dynasties 5-6 in Sinai, south Palestine, and Nubia, perhaps fueled in part by an increased demand for copper (Mumford 2006, 54-5).

<sup>630</sup> Muhly 1973a, 218-9; Pritchard 1950, 229-30; Rothenberg 1973, 26, 63; Lucas and Harris 1999, 202-9; Ogden 2000, 150-1. Cassiterite (tin ore) deposits have also been discovered in Egypt's Eastern Desert in modern times, although the size of these deposits has been disputed. So far, there is no evidence of their exploitation in the Bronze Age, though the Egyptians exploited other minerals in the region (Maddin et al. 1977, 38; Muhly 1978, 45; 1985c, 283; 1993, 244-8; Rapp et al. 1999).

<sup>631</sup> Stos-Gale 1993, 115.

<sup>632</sup> Shepherd 1993, 116; Branigan 1968, 52, 57; Gale 1991, 204; Evely 2000, 330-2. Evely (2000, 335) disagrees with Branigan, basing his opinion on recent geological and lead-isotope work on copper ores on Crete: "Since the picture as now understood denies to Crete any metal-extraction on any discernible scale, it is not surprising to find no evidence (mines or slag heaps) on the ground."

attest to the size and sophistication of this industry.<sup>633</sup> Early Minoan metalwork, particularly in the manufacture of copper daggers, likely influenced the styles of metal objects found in other parts of the Aegean and in Cyprus; the importance of Minoan metalwork continued into later periods as well.<sup>634</sup>

Lead-isotope analyses of copper and bronze artifacts from Minoan sites indicate that the Cycladic Islands of the Aegean were an important source of metals in the Early and Middle Minoan period. Copper deposits in the Cyclades were certainly exploited during the Early Bronze Age (c. 2500-2000 B.C.).<sup>635</sup> Copper slag heaps on the islands of Kythnos and Seriphos have been dated to the Early Helladic period, indicating that sulphidic copper ores were smelted, while silver ores were exploited on the nearby island of Siphnos in the same period.<sup>636</sup> Lead isotope analyses of the famous silver objects from the Shaft Graves at Mycenae (c. 1600 B.C.) show that some are consistent with an origin in the Laurion ore deposits, while others were made from an unidentified, non-Aegean source.<sup>637</sup> Most (90%) LBA lead objects from the Aegean have a lead isotope ‘fingerprint’ consistent with Laurion ores as well; the majority of the approximately 100 lead fishnet weights from the Uluburun shipwreck also seem to have originated in Laurion, although a large group have lead isotope signatures consistent with a source in the Taurus Mountains of Anatolia, while others may have

<sup>633</sup> Evely 2000, 335-90; Chadwick 1976, 140; Dimipolou 1997; Soles and Davaras 1994; 1996; Soles and Stos-Gale 2004, 45-59; Whitley 2005, 102-3.

<sup>634</sup> Stos-Gale 1993, 119; Strange 1980, 91, 93-6; Wiener 1990, 146.

<sup>635</sup> Stos-Gale and Gale 1990, 74; Gale et al. 1985, 81-101; Stos-Gale and Gale 1986, 23-34; Sheperd 1993, 108-13, 116.

<sup>636</sup> Gale and Stos-Gale 1984; Wagner et al. 1980; Gale 1989; Stos-Gale and MacDonald 1991, 254, 256-81; Gale 1998, 738-40; Stos-Gale 1998, 720, 726-7. The nearby island of Seriphos has no copper ore deposits, although two undated ancient slag heaps are known on the island with lead isotope signatures of Kythnos copper ore, indicating that the ore was imported to the site before smelting (Stos-Gale 1993, 124). Copper slag has also been found on the Cycladic island of Kea at Ayia Irini, which included an area apparently involved in silver production as well (Stos-Gale 1993, 124; 1998, 720; Cummer and Schofield 1984, 38, 114; Wiener 1990, 148).

<sup>637</sup> Stos-Gale and MacDonald 1991, 272.

originated from Siphnos, Chalkidiki, and the Troad.<sup>638</sup> Evidence of trade between Minoan Crete and the Cyclades begins in the third millennium B.C.<sup>639</sup> By c. 1700-1600 B.C., a great degree of Minoan political control and/or cultural influence is apparent in the Cyclades. Minoan material culture, particularly domestic pottery (the ‘Minoan kitchen kit’), are dominant in the Cyclades by the mid-second millennium B.C.<sup>640</sup> The settlement of Akrotiri (or Santorini) on Thera, destroyed in the mid-17th century B.C., had clearly embraced Minoan culture even if Minoans from Crete had not actually settled there in large numbers.<sup>641</sup> Copper deposits are also known to exist in many areas of Greece, particularly in the northeast and eastern parts of the country, although evidence of Bronze-Age exploitation is lacking.<sup>642</sup> Besides being an important source of silver and lead, Laurion in Attica may have also had copper deposits that were exploited in the Bronze Age, although its role in the Bronze Age copper trade is still debated.<sup>643</sup> These deposits were likely exploited in the Early and Middle Minoan period to some extent, judging from lead-isotope analyses of weapons of this period.<sup>644</sup>

Ore deposits further from the eastern Mediterranean may have also played a role in the metals trade in the Mediterranean. Copper deposits exist in **Elba and Tuscany**, but there is no evidence for their exploitation in the Bronze Age.<sup>645</sup> Radiocarbon dates clustering in the mid-fourth millennium B.C. have recently been published for ancient

<sup>638</sup> Stos-Gale and MacDonald 1991, 272, 274; Pulak 2001, 23.

<sup>639</sup> Broodbank 1993, 326.

<sup>640</sup> Wiener 1990, 135-40.

<sup>641</sup> Wiener 1990, 129, 135-40, 146-8, 151-4.

<sup>642</sup> Stos-Gale and Gale 1990, 74; Sheperd 1993, 110; Stos-Gale 1998, 718; McGeehan Liritzis 1996, 118-9, Fig. 3.2.1, 6.9.1.1, A-E.

<sup>643</sup> Stos-Gale and Gale 1991, 255; Wiener 1990, 148; Stos-Gale 1993, 120.

<sup>644</sup> Stos-Gale 1993, 120.

<sup>645</sup> Shepherd 1993, 143-4.

mining remains from **Monte Loreto** in northwest Italy, making the site the oldest securely dated copper mines in western Europe.<sup>646</sup> Large copper deposits were exploited in the Alps at a significant scale in the Bronze Age; one area of the **eastern Alps** may have produced up to ten tons of copper per year according to one estimate.<sup>647</sup> *Ösenhalsringe* ('ring ingots') and *Rippenbarren* ('rib-shaped ingots'), which likely came from these Alpine sources, are found often in hoards of hundreds of ingots, and are generally distributed to the north of the Alps, in Bavaria, lower Austria, and Moravia, rather than south towards the Mediterranean.<sup>648</sup> It therefore seems likely that Alpine sources supplied primarily, if not exclusively, the northern European market for copper rather than the Mediterranean one.

**Sardinia** has significant metal deposits, especially silver/lead ores (galenas) as well as copper, all of which were being exploited by the Late Bronze Age; numerous copper bun ingots, oxhide ingots, ingot fragments, and locally made bronze objects have been uncovered there.<sup>649</sup> Although metallic tin was recently recovered from a Nuragic site on Sardinia and small tin deposits are known on the island, there is no evidence that they were exploited in the Bronze Age; tin was probably imported to the island.<sup>650</sup>

**The largest copper source in the eastern Mediterranean is the Troodos massif in Cyprus.**<sup>651</sup> The exact role of Cypriot copper deposits in the development of Bronze Age Mediterranean societies is still debated, but evidence show that this source was

<sup>646</sup> Maggi and Pearce 2004, 66-8, 76.

<sup>647</sup> Harding 2000, 210-5, 235; Shennan 1998; Doonan 1999; Pearce 2000; Herdits 2003.

<sup>648</sup> Harding 2000, 218-9.

<sup>649</sup> Becker 1980, 99, 101; Gale and Stos-Gale 1987a, 143, 145-6; Shepherd 1993, 147-8.

<sup>650</sup> Fadda 2003, 138; Giardino 1992; Gale and Stos-Gale 1992; Valera and Valera 2003, 3-4, 6-9; LoSchiavo 2003, 121-4.

<sup>651</sup> Shepherd 1993, 113-5.

being exploited as early as the fourth millennium B.C., and played a major, if not a dominant, role in the eastern Mediterranean copper trade by the Late Bronze Age.<sup>652</sup>

Alloying materials, particularly arsenic and tin, became important in copper metallurgy by the late fourth and third millennium B.C. The first bronze objects produced were made of copper/arsenic alloys; these became common in the Near East and the Mediterranean in the period between 3200 and 2200 B.C.<sup>653</sup> The use of arsenic to alloy copper may have begun accidentally, when copper ores containing arsenic were smelted; later, smelters may have deliberately selected such ores based on the superior aesthetic quality of the results (arsenic can give copper surfaces an aesthetically pleasing silver appearance and was even used by the Egyptians to make reflective surfaces for mirrors) as well as the increased hardness and castability of the finished metal.<sup>654</sup> Arsenic also reduces the amount of copper oxide in copper, which will lower the copper's melting point, increase its ductility and hardness and makes it more suitable for coldworking.<sup>655</sup>

Arsenic may have been exploited for metallurgical use in the form of arsenopyrite (FeAsS), sometimes found intermingled with copper sulfide ores. Some copper ores contain significant amounts of arsenic, particularly enargite (Cu<sub>3</sub>AsS<sub>4</sub>, which is 19% As and 46% Cu), and tennantite (Cu<sub>3</sub>AsS<sub>3</sub>, which is 21% As and 53% Cu); these two minerals also have a very distinctive metallic appearance which would allow them to

<sup>652</sup> Shepherd 1993, 114.

<sup>653</sup> Muhly 1973a, 350. Other copper alloys were produced in the Chalcolithic and Bronze Age, for example, Cu/Zn and Cu/Zn/Ni alloy objects from Egypt; Cu/Sb, and Cu/As/Ni and Cu/As/Sb alloy objects are also known (Ogden 2000, 155; Evely 2000, 328; Charles 1980, 170). However, such alloys were most likely produced accidentally from ores containing relatively high levels of these metals (Charles 1980, 170; Evely 2000, 328; Ogden 2000, 155).

<sup>654</sup> Stos-Gale and Gale 1990, 75; Charles 1967, 22; Muhly 1980, 26; 1999, 18.

<sup>655</sup> Charles 1967, 22; 1980, 170-1; Evely 2000, 328.

be distinguished from most copper minerals.<sup>656</sup> Orpiment and realgar, both used as pigments by ancient cultures, could have also been easily recognized sources of arsenic for alloying.<sup>657</sup> The copper ores found at Kythnos in the Cyclades, at Laurion in Attica, and in parts of Cyprus often contain arsenic; the first two sources were exploited in the Early Bronze Age.<sup>658</sup> Arsenic, unlike tin, was probably not recognized as a useful metal in itself; native arsenic oxidizes rapidly on exposure to air.<sup>659</sup> Copper ores high in arsenic could, however, have been deliberately selected by metallurgists based on prior experience in producing a superior quality metal from such ores, as could arsenic minerals such as orpiment or realgar, which were also used as pigments.<sup>660</sup> The use of arsenic vs. tin bronzes, however, may not have been determined by the function of the objects in many cases. In his study of the correlation between the use of copper alloys and pure copper in a group of Early and Middle Cypriot objects, S. Swiny found that there is no real correlation between the function of the object and the use of particular alloys. For example, tin or arsenic bronze was not necessarily selected to make tools or weapons, and the softer pure copper was not necessarily used to manufacture decorative items such as pins.<sup>661</sup> This evidence indicates that these objects were probably made in a period of experimentation, before metallurgical techniques had become particularly efficient or standardized.<sup>662</sup> Considerations other than the mechanical properties of the metal must also be taken into account; arsenic additions to copper can produce an aesthetically pleasing silver

---

<sup>656</sup> Charles 1967, 24-5; 1980, 168-72.

<sup>657</sup> Charles 1967, 25. See Giunlia-Mair 2005, 421 for color photographs of realgar and orpiment.

<sup>658</sup> Stos-Gale and Gale 1990, 72, 75; Zwicker 1982, 64.

<sup>659</sup> Charles 1967, 25.

<sup>660</sup> Muhly 1999, 15; Charles 1967, 25; 1980, 169; Tylecote 1982a, 97. Arsenic lowers the melting point of copper as low as 830° Celsius for some copper alloys (Charles 1980, 170-1; Evely 2000, 328).

<sup>661</sup> Swiny 1982, 76; Gale et al. 1996, 373-4.

<sup>662</sup> Swiny 1982, 76-7.

color, so it may have been preferentially selected for jewelry or other decorative objects.<sup>663</sup>

Arsenic was gradually replaced by tin for alloying copper. Although there are no significant differences in metallurgical properties between the two alloys, arsenic is highly volatile and the toxicity of arsenic vapors were likely a significant health risk to metalworkers.<sup>664</sup> Stech and Piggott (1986) and Gillis (1999a; 1999b) have proposed that tin alloyed bronze was viewed as a status symbol in the earlier part of the Bronze Age because it was imported from great distances; this importation may have been necessary for areas in which good copper arsenate ores were unavailable.<sup>665</sup> This could explain the rarity of pure tin artifacts in the Bronze Age as well as the occurrence of tin foil-plated Mycenaean pottery vessels from the 14th century B.C.<sup>666</sup> This manufacturing technique is most likely an attempt to produce a prestige object while using a minimal amount of metal.<sup>667</sup> Tin bronze was widely used in the Mediterranean by the end of the third millennium B.C., although arsenic bronze continued to be used

<sup>663</sup> Charles 1980, 171.

<sup>664</sup> Stech and Piggott 1986, 48; Charles 1967, 26; Rapp 1999, 702.

<sup>665</sup> Stech and Piggott 1986, 48, 58; Philip 1991, 83; Gillis 1999, 289-91.

<sup>666</sup> Muhly 1978, 46; Gillis 1999b, 141-2; Pulak 2001, 43.

<sup>667</sup> Gillis (1999b, 142) states in relation to these vessels that “one is led inevitably to the conclusion that the phenomenon of coating pottery with tin foil to deposit in graves must be a status statement *par excellence*... It is not unjustified to suggest that for the Aegean Late Bronze Age society, tin ranked as a status metal on a par with silver, and perhaps not far from gold. It was used *in its own right* in these prestigious burials, conferring status and prestige on the deceased and his/her family.” This explanation seems inconsistent with her own research on the vessels. She states that the foil can be heat-treated until it turns a golden color, yet this gold-colored foil would eventually have “darkened, dulled, and partially fallen off” over time, and that tinfoil-covered vessels would clearly have not been mistaken for gold due to their weight (Gillis 1999b, 142). The idea that tin was valued “on a par with silver, and perhaps not far from gold” is also difficult to accept in light of Old Assyrian texts in which the tin given a value a fraction of that of silver (Muhly 1980a, 39). These vessels are more likely an example of an economical imitation of prestige goods, such as the ceramic imitations of Late Cypriot bronze tripod and four-sided stands which were produced in the late second millennium B.C. (Catling 1964, 213-21).



for several more centuries in some areas, particularly on Cyprus.<sup>668</sup> The percentage of tin to copper in tin bronze objects varied, but is typically between 5-15% tin (10% tin is considered ideal by modern metallurgists).<sup>669</sup>

Since tin is very rare in the Mediterranean and surrounding areas, the development of tin bronze would have stimulated the importation of large amounts of tin by Bronze Age societies. Tin, in the form of cassiterite nodules (tin oxide, which can be up to 80% pure tin), were, like gold, usually obtained from placer deposits in riverbeds by panning; this process could leave few traces archaeologically, but cassiterite would have to come from an exposed vein that should be geologically detectable.<sup>670</sup> Large tin deposits were exploited in later times in **Iberia and Cornwall**, but there is as yet little evidence for Bronze Age exploitation of tin deposits outside of Cornwall and no solid evidence for a trade in western Mediterranean tin to the east before the first millennium B.C.<sup>671</sup> **Large tin lodes also exist in the Alps, although these are almost never found in placer deposits; according to Muhly, there is no evidence for their exploitation before the 12th century A.D.**<sup>672</sup> Small placer deposits of tin occur in the

<sup>668</sup> Muhly 1973a, 350; see also Philip 1991, 67-8, 81, 83, 86-7 for the use of arsenic bronze on Cyprus into the second millennium B.C.

<sup>669</sup> Tylecote 1982a, 97-8; Muhly 1980a, 46, 48.

<sup>670</sup> Penhallurick 1986, 153-68.

<sup>671</sup> Muhly 1973a, 183, 268-9; 1985c, 286-7; see also Penhallurick 1986, 150-2, 173-221, for prehistoric artifacts found in tin mining areas of Cornwall.

<sup>672</sup> Muhly 1985c, 288-90; 1987, 102. Penhallurick (1986, 71) challenges this assertion by disputing the idea that hard-rock tin mining was too difficult for prehistoric miners; he states that “tin bronze was known in Europe before the discovery of Cornish [placer] deposits,” that fire-setting, a mining technique known to have been used by prehistoric miners, could have been used to mine tin from the Erzgebirge, and that in some cases softer rock borders the hard quartz veins containing the tin deposits, which would have made mining tin easier. Evidence for fire-setting has been observed in the Kestel mine in the Taurus Mountains of Turkey, in ancient tin mines in central Asia, and at Bronze Age sites in the Mitterberg where chalcopyrite ore was mined (Craddock 1995, 33-8; Harding 2000, 211; Cierny et al. 2005, 435). A. Giuulia-Mair notes a fairly abundant use of tin in Late Bronze Age artifacts from the eastern Alpine region, as well as historical references to tin in the Erzgebirge, but concludes that “Bronze Age and Iron Age artisans” in the region “had no particular problems with the supply of tin” (Giuulia-Mair 2003, 93, 104-6).

eastern desert of Egypt, in Greece, and in Sardinia and southern Tuscany, but there is no evidence that they were exploited in the Bronze Age, and the central Mediterranean and Greek deposits in particular are quite small.<sup>673</sup> Cassiterite deposits are also known in **Bulgaria**; these may have been used in a local tin bronze industry as early as c. 4200 B.C., although the impact of this activity (if any) on Mediterranean metallurgy seems to have been negligible.<sup>674</sup> Judging from the size of the bronze industry, it is also possible that small tin sources that were exploited in the Mediterranean region were completely exhausted by the late second millennium B.C.<sup>675</sup>

The theory that small tin deposits in the eastern Mediterranean were exploited in the Bronze Age until they were exhausted is supported by recent work at the sites of **Kestel and Göltepe** in the Bolkardağ region of the Taurus Mountains of central Anatolia. The mining and processing of tin and possibly other metals occurred at these sites during the Early through the Middle Bronze Age (c. 3000-2000 B.C.), when the source was apparently exhausted.<sup>676</sup> Tin was coming into common use in Anatolia in

<sup>673</sup> Muhly 1973a, 255, 259, 332; 1978, 45; 1985a, 132; Valera and Valera 2003, 3-4; Benvenuti et al. 2003, 55-7; Skarpelis 2003; Tylecote et al. 1984, 122-3.

<sup>674</sup> Glumac and Todd 1991, 10, 14-5; Stos-Gale et al. 2003, 168.

<sup>675</sup> Muhly 1973a, 350.

<sup>676</sup> Yener and Goodway 1992, 85; Willies 1991, 102; Yener and Vandiver 1993a, 214; 1993b, 261-2; Yener 2000, 70-3; Yener et al. 2003. The results of Yener's excavations in the Bolkardağ region at the site of the Kestel mine and neighboring settlement of Göltepe have been particularly controversial. Rapp (1999, 704) states that in the Kestel mine there is "no cassiterite to be observed anywhere" and that the "'mine'... [was] certainly occupied by Bronze Age peoples, [but] has more the characteristics of a cave." Muhly (1993, 251-3) believes that the Kestel site is a mine, but that the low tin content of the ore veins (around 1.5% cassiterite, according to Yener and Vandiver 1993a, 234) makes the mining of tin uneconomical; he suggests that iron was mined there in antiquity some time after the Early Bronze Age. Pernicka et al. (1992, 93, 95-6) concur with Muhly that the amounts of tin in the deposit are too small for economical exploitation, and believe gold may have been mined at Kestel in the third millennium B.C. (based on four radiocarbon dates from debris at the site), since gold also occurs in the same quartz veins in which the tin is found. Yener and Vandiver respond to these criticisms with the results of the excavation of the neighboring habitation site of Göltepe two kilometers away, in which over 50,000 ground stone tools, a possible ingot mold, slag, ore, and approximately 250 crucible fragments have been uncovered. Twenty-four of the crucible fragments were analyzed using X-ray fluorescence, SEM microscopy and energy-dispersive X-ray analysis (EDS); twenty-one were found to contain tin oxide residues on their interior sides only (Yener and Vandiver 1993a, 211, 216, 221, 226-35; 1993b, 257). They have also presented a reconstruction of how tin could be smelted in such

the third millennium B.C., likely due at least in part to local exploitation of tin sources, some perhaps too small to be easily detectable today.<sup>677</sup>

None of the identified Anatolian sources could have supplied the total amount of tin required by Middle and Late Bronze Age Mediterranean cultures, so much of the tin used was transported from further afield. Although not as rare as silver, gold, or iron during this period, tin was considered a precious metal, yet was also a more generally useful metal because of its use in bronze production.<sup>678</sup> Tin was one of the mainstays of the trade between Assur in Syria and central Anatolia, including Kanish. In the Kanish texts, tin is typically sold for between six to sixteen shekels of silver for one mina of tin, a ratio of silver/tin of 1:4 to 1:10; in one text, a talent of tin is stated to be able to fetch at least a mina of gold, giving a gold to tin ratio of 1:60.<sup>679</sup> Tin was sometimes used as a type of currency to cover traveling expenses of Assyrian caravans traveling into Anatolia, similar to the use of silver and gold in the same period.<sup>680</sup> As a precious metal with a wide variety of uses, it is possible that tin was traded into the Mediterranean from several different directions, although it seems to have primarily

---

crucibles (Yener and Vandiver 1993a, 235-6; 1993b, 258-9, 261; Yener 2000, 121-4; Yener et al. 2003, 189-95; Northover and Gillis 1999, 80). In response to Muhly's assertion that the cassiterite particles present at the mine are too small to be easily recognized by ancient miners (1993, 252), Yener and Vandiver (1993b, 255, 257) state that the small particles of tin at the mine are easily recognized by their distinctive purple and red colors as well as their high density, so that they could have been retrieved by panning or vanning. The relatively low amounts of tin present at the site today is attributed to ancient exploitation; according to the excavators, the richer deposits were removed in antiquity (c. 3000-2000 B.C., based on pottery finds and radiocarbon dates) (Yener and Vandiver 1993a, 214-5; 1993b, 261-2). The original amounts of ore have been estimated at one or several hundred tons (Willies 1992, 101; 1993, 263). Yener and Vandiver also argue that tin deposits with lower percentages of tin than those found at Kestel have been judged exploitable, for example some tin deposits in Cornwall today (Yener and Vandiver 1993a, 214-5; Willies 1993, 264).

<sup>677</sup> Yener and Vandiver 1993a, 212-3; 1993b, 255-6; Muhly 1993, 239-43; 1999, 18-21; Yener 2000, 74-5.

<sup>678</sup> Willies 1992, 102; Muhly 1980, 34-6; Waldbaum 1980, 69, 72, 75, 79-81; Rothenberg 1990, 182-9.

<sup>679</sup> Muhly 1980, 34-5. Assyrian officials took great pains to prevent the smuggling of iron to Anatolia, judging from published texts from Kanish (Veenhof 1972, 306; Muhly 1980, 35).

<sup>680</sup> Veenhof 1972, 32.

come from the east. Tin was traded from an eastern source through Assur and Mari in the early second millennium B.C., perhaps as far west as Crete; the tin arrived from the east, being transported up the Euphrates to Mari, indicating that it probably originated in northwest Iran, Afghanistan, or elsewhere in central Asia and traveled from an eastern center such as Susa or Anshan in Iran, through Eshnunna before reaching Mari.<sup>681</sup> Tin inventories from 18th century B.C. Mari mention that tin was transported up the Euphrates to the city in large amounts, ranging from several minas to up to ten talents, and delivered to various individuals, mainly royalty and elites, in the kingdoms of Yamhad (Aleppo) and other locations in Syria and Palestine.<sup>682</sup> Large consignments of tin were received at Mari, one totaling sixteen talents and ten minas, or about 500 kg.<sup>683</sup> A single reference to the import of “tin from Meluhha” is known from a Sumerian text from the reign of Gudea of Lagash (c. 2150-2111 B.C.).<sup>684</sup> Meluhha is most commonly located by modern scholars in Pakistan or Afghanistan, where the contemporary Indus Valley civilization flourished, producing high quality tin bronzes.<sup>685</sup>

Some tin deposits are known in India and Pakistan, but they are relatively insignificant in comparison to Central Asian deposits; it seems more likely that the designation “tin from Meluhha” indicates that the tin was shipped to Mesopotamia from Meluhha rather than mined there (similar to the designation “copper from Tilmun”, a site involved in maritime trade with Mesopotamia which seems to have been a trading port rather than a metal production center).<sup>686</sup> Meluhha was involved in long-distance sea

<sup>681</sup> Muhly 1973a, 348; McKerrell 1978, 21; Cleuziou and Berthoud 1982, 17; Pulak 2001, 239.

<sup>682</sup> Muhly 1973b, 407; Malamat 1971, 31, 33-8.

<sup>683</sup> Malamat 1971, 31.

<sup>684</sup> Cleuziou and Berthoud 1982, 17; Penhallurick 1986, 21.

<sup>685</sup> Cleuziou and Berthoud 1982, 17; Penhallurick 1986, 21-3.

<sup>686</sup> Penhallurick 1986, 21; Muhly 1973a, 307.

trade with Mesopotamia, Oman, and likely overland trade with central Asia; lapis lazuli, copper, and carnelian were also imported to Mesopotamia from Meluhha.<sup>687</sup>

Archaeological and geological investigations in central Asia have located a number of important tin sources and uncovered evidence for large-scale Bronze Age tin mining as early as the second millennium B.C.<sup>688</sup> Recently the potential sources of Meluhha tin were identified in the **Zeravshan valley in Uzbekistan and Tajikistan**; ancient tin mining galleries at **Karnab and Mushiston** were identified and dated by pottery and C-14 dates as Andronovo cultural material, dating to c. 2000-1500 B.C.<sup>689</sup> At Mushiston in Tajikistan, tin ores occur mixed with copper ores; Cierny and Weisgerber suggest that these ores were accidentally smelted together; when ancient metallurgists discovered the superior quality of the result, they may have begun to deliberately alloy copper with tin.<sup>690</sup> Tin deposits have also been identified in **eastern Kazakhstan**.<sup>691</sup>

**Colchis** in the Black Sea is also mentioned as a source of tin in classical times; **perhaps this region served as a transshipment point for tin originating from the same region of Central Asia** as tin arriving in the Near East from more southerly routes.<sup>692</sup> It is likely that several tin routes were utilized, including direct routes overland from central Asia through Iran, as well as sea routes from Meluhha to Mesopotamia and possibly a land or sea route from the Caucasus to the Black Sea and the Mediterranean.

<sup>687</sup> Cleuziou and Berthoud 1982, 17-8; Muhly 1973a, 307-10; Penhallurick 1986, 24-5.

<sup>688</sup> Penhallurick 1986, 26-32; Muhly 1973a, 316.

<sup>689</sup> Cierny and Weisgerber 2003, 24-9; Piggott 1999, 4; Cierny et al. 2005.

<sup>690</sup> Cierny and Weisgerber 2003, 28-9.

<sup>691</sup> Cierny et al. 2005, 440.

<sup>692</sup> Muhly 1973b, 406.

Trade of tin from the western Mediterranean and Atlantic coasts of Europe occurred in later antiquity but is not well attested for the Bronze Age.<sup>693</sup> An overland trade in Baltic amber from northern Europe to the Mediterranean occurred in the Late Bronze Age; tin from central and western Mediterranean sources could have been exchanged on this trade route as well.<sup>694</sup> Some metals from the Mediterranean seemed to have circulated along this route. At least four copper oxide ingot fragments were traded as far as Oberwilfligen in Bavaria, where they were discovered in a Late Bronze Age copper hoard dating to the 14th or early 13th century B.C. and consisting primarily of ingot fragments (most from plano-convex ingots) and axe heads.<sup>695</sup> The chemical and lead isotope composition of these ingots is consistent with that of Cypriot copper ore sources.<sup>696</sup>

However, even if metals were exchanged on the Baltic amber trade routes, the volume of this trade was likely small in comparison to trade routes linking the Mediterranean with central Asia via the highly developed civilizations of Mesopotamia. A. Sherratt proposes that before the 13th century B.C. the trade between central Europe, the central Mediterranean, and the eastern Mediterranean may have been contacts between two essentially different exchange systems-- an Aegean/Near Eastern and a central European trade sphere-- which developed and operated largely independent of each other for most of the Bronze Age.<sup>697</sup> The trade of amber may have resembled a "trinket trade" rather than a bulk trade, in which relatively small amounts of high-value items (amber, bronzes, possibly faience beads) were transported overland over

---

<sup>693</sup> Penhallurick 1986, 127-8, 132; Muhly 1973b, 406, 409-10.

<sup>694</sup> Penhallurick 1986, 132-8; Sandars 1985, 91-100; Bouzek 1985; Sherratt 2000.

<sup>695</sup> Primas and Pernicka 1998, 25-35.

<sup>696</sup> Primas and Pernicka 1998, 61.

<sup>697</sup> Sherratt 1993, 250-1.

extremely long distances; the early trade in lapis lazuli was likely similar to the amber trade in this respect.<sup>698</sup> The bulk transport of raw materials in significant amounts, which may have included tin, cannot be ruled out, however.<sup>699</sup>

In the first millennium B.C., tin traveled to the eastern Mediterranean by sea from Tartessos (southern Spain) or by sea from the “Tin Islands” (Cassiterides) through France, mostly by rivers, to the Greek colony of Massalia (Marseille) and points east.<sup>700</sup> If a similarly important route was in use in the Bronze Age, we would expect to see more eastern Mediterranean goods in the central and western Mediterranean. This is not the case, at least for the western Mediterranean, although a few isolated artifacts are known (including two sherds identified as Mycenaean pottery in southern Spain<sup>701</sup> and two copper oxide ingots found off the Mediterranean coast of France); significant concentrations of eastern Mediterranean goods (especially Mycenaean pottery) are found only as far west as Sardinia, southern Italy, Sicily, and the Aeolian Islands.<sup>702</sup> The presence of Cypriot or other eastern Mediterranean metallurgists in Sardinia could explain the strong similarities between Cypriot and Sardinian metalworking tools and bronzes; some scholars propose that they traveled to the central Mediterranean for tin and other metals.<sup>703</sup> The presence of a stone mold for casting winged axes, an Italian axe type foreign to the eastern Mediterranean, in a LH

<sup>698</sup> Sherratt and Sherratt 1991, 354, 358-60; Hermann 1968; Bouzek 1985, 58-9; Penhallurick 1986, 24-5.

<sup>699</sup> Cunliffe 2001, 345, 349, 352; Sherratt 1993, 251.

<sup>700</sup> Muhly 1973a, 262-70.

<sup>701</sup> The Mycenaean sherds were found at the site of Llanete de los Moros in the upper Guadalquivir Valley, in a late 14th/13th century BC context. These sherds most likely reached Spain through central Mediterranean intermediaries, since contact between Sardinia and the Iberian peninsula in the Bronze Age is well-documented (Vagnetti 1996, 114).

<sup>702</sup> Vagnetti 1996, 109-14; 2001, 78-88; Hallager 1985; Giardino 1992; LoSchiavo 1992; Ridgway 1996; Domergue and Rico 2002, 141-52.

<sup>703</sup> Gale and Stos-Gale 1988, 382; Smith 1987, 46; Stos-Gale and Gale 1992, 336; Ridgway 1996, 118; Kassianidou 2001, 110; LoSchiavo 2001, 141-2; Kassianidou and Knapp 2005, 225.

IIIB context in the House of the Oil Merchant at Mycenae may indicate the transfer of central Mediterranean metallurgists or metallurgical technology to the eastern Mediterranean as well.<sup>704</sup> A Sardinian interest in iron, of which Cyprus was an early major producer in the eastern Mediterranean, has also been proposed as another possible metallurgical connection between the two islands.<sup>705</sup> However, there is as yet little evidence for what eastern Mediterranean traders were seeking. A few objects produced in Iberia or possibly influenced by western Mediterranean models are known from Sardinia, indicating that some trade links existed.<sup>706</sup> Tin deposits are known in three areas of Sardinia which were exploited in modern times, but due to the nature of the deposits it is unlikely that they were rich enough to be exploited in the Bronze Age. Lead isotope analysis of tin and tin oxide samples obtained from Nuragic sites on Sardinia indicate that the tin was not from local sources (unlike other samples of lead and copper objects) and, therefore, must have been imported to the island.<sup>707</sup> Tin from Tuscany, Brittany, Iberia, the Alps, or Cornwall could have been traded to Sardinia, perhaps to supplement meager or exhausted tin deposits on the island itself.<sup>708</sup>

Archaeological examples of tin ingots and pure tin objects from the Bronze Age Mediterranean are uncommon. Egyptian tomb paintings depict large numbers of tin ingots, in rectangular, oxhide, and “anchor” shapes; all have been attested in the archaeological record from underwater finds at Uluburun and off the coast of Israel at Haifa.<sup>709</sup> Equally rare are finds of pure tin objects such as a tin 'pilgrim flask' from Uluburun (only six finished tin objects from the Bronze Age Mediterranean are

<sup>704</sup> Giardino 2000b, 100; see also Stubbings 1979b, 297-8.

<sup>705</sup> LoSchiavo et al. 1990, 209, 211, 213; Waldbaum 1980; 1982; Snodgrass 1982.

<sup>706</sup> Giardino 1992, 308; 1995, 339-41; Stos-Gale and Gale 1992, 333.

<sup>707</sup> Valera and Valera 2003, 3-10.

<sup>708</sup> Stos-Gale and Gale 1992, 336; Valera and Valera 2003, 3-4.

<sup>709</sup> Bass 1967, 52-7; Muhly 1978, 45-6; Pulak 2000a, 151.



known).<sup>710</sup> Fifteen tin ingots of various shapes found on several sites off the Israeli coast near Haifa have been dated to the Bronze Age based on markings resembling Cypro-Minoan or their association with Bronze Age artifacts (including a copper oxide ingot at one site), which probably represent the remains of Bronze Age ship cargoes.<sup>711</sup> Nearly all of the tin ingots found on the Uluburun shipwreck were deliberately cut into halves or quarters.<sup>712</sup> According to Pulak, this may indicate that they have changed hands several times and were not collected where the tin was first smelted; the heterogeneous nature of this collection supports the hypothesis that they were traded over a great distance.<sup>713</sup> Hauptmann et al. (2002) made chemical analyses of thirty-two of the Uluburun tin ingots, and found that they were composed of highly pure tin with low levels of other elements which were likely natural impurities.<sup>714</sup> The Cape Gelidonya wreck produced no intact tin ingots but approximately 8 kg of tin oxide corrosion product was recovered, indicating that tin in some form was being transported on the vessel.<sup>715</sup>

Metallographic and isotopic analyses of ancient tin ingots have produced fewer conclusive results. This is due largely to the chemical properties of tin and cassiterite. Impurities that could be potentially diagnostic in smelted tin are often present in cassiterite in only small quantities, due to its high purity, and the fact that impurities tend to be partitioned into slag during smelting.<sup>716</sup> Tin isotopes are at such low levels that they have been proven difficult to detect, while the sourcing of lead impurities in

---

<sup>710</sup> Pulak 2001, 243; Muhly 1980, 34-5; Bass 1989, 11.

<sup>711</sup> Galili et al. 1986, 25, 32-3; Muhly 1978, 46; Raban and Galili 1985, 326; Kassianidou 2003, 112-4.

<sup>712</sup> Pulak 2001, 239-40.

<sup>713</sup> Pulak 2001, 239-40.

<sup>714</sup> Hauptmann et al. 2002, 16.

<sup>715</sup> Bass 1967, 41, 82-3.

<sup>716</sup> Northover and Gillis 1999, 78.

ancient tin has been questioned due to the fact that lead was frequently added to tin.<sup>717</sup> Corrosion of tin can also render chemical analyses of tin and tin alloys inaccurate, particularly since trace elements from the surrounding environment can be absorbed during the corrosion process.<sup>718</sup>

Some analyses have been attempted, however. Attempts have been made to distinguish between samples taken from cassiterite deposits in the Erzgebirge region and the Eastern Desert of Egypt using neutron activation analysis.<sup>719</sup> Metallographic analyses of tin ingots from Uluburun produced no conclusive results due to the fact that the tin had converted from white (metallic) tin to grey tin, a reaction which begins to occur around 13° Celsius; in this state, the tin becomes a gray, powdery, crystalline substance, and expands in volume by about 25%.<sup>720</sup> In this state, the original metallographic structure is destroyed, so that an analysis of the tin is impossible.<sup>721</sup> The instability of tin at low temperatures has been proposed by LoSchiavo (2003) as a reason for the relative paucity of metallic tin finds on Bronze Age sites in Sardinia and elsewhere; she suggests that grey tin may have been found in some circumstances and not recognized by excavators as a metal.<sup>722</sup>

Lead isotope analyses of 99 of the tin ingots from the Uluburun ship have produced more conclusive results.<sup>723</sup> The isotopic compositions of the tin ingots plot as at least two distinct groups, indicating that they probably originate from two distinct

---

<sup>717</sup> Northover and Gillis 1999, 78.

<sup>718</sup> Northover and Gillis 1999, 79.

<sup>719</sup> Rapp et al. 1999.

<sup>720</sup> Maddin 1989, 102.

<sup>721</sup> Maddin 1989, 102-4.

<sup>722</sup> LoSchiavo 2003, 128.

<sup>723</sup> Pulak 2000a, 153.

sources.<sup>724</sup> The two groups also have significantly different concentrations of lead, which further supports the hypothesis that two separate sources were utilized.<sup>725</sup> The four tin objects from the Uluburun ship match the group with the higher lead concentration,<sup>726</sup> and tin ingots recovered from the Bronze Age ship cargo found off Hishule Carmel on the coast of Israel also show similar lead isotope concentrations to one of the groups of Uluburun tin ingots.<sup>727</sup> The sources of the Uluburun tin ingots have not been identified, although preliminary research excludes at least some tin deposits in the Erzgebirge region of eastern Europe, Cornwall, and Spain as potential sources.<sup>728</sup> One of the Uluburun tin ingots' lead isotope clusters overlaps isotopic data from ores in the Bolkardağ Valley in the Taurus Mountains of central Turkey.<sup>729</sup> About half of the ingot samples are consistent with a source in the Bolkardağ valley, which suggests that tin from the Taurus Mountains may have been exported into the Late Bronze Age.<sup>730</sup> However, all of these results are preliminary, and need further sampling and analysis.<sup>731</sup>

---

<sup>724</sup> Stos-Gale et al. 1998, 119; Pulak 2000a, 153-5; 2001, 23.

<sup>725</sup> Stos-Gale et al. 1998, 119; Pulak 2000a, 153, 155.

<sup>726</sup> Pulak 2000a, 155.

<sup>727</sup> Stos-Gale et al. 1998, 119, 126.

<sup>728</sup> Stos-Gale et al. 1998, 119-20; Pulak 2000a, 155; 2001, 23.

<sup>729</sup> Pulak 2001, 23.

<sup>730</sup> Pulak 2001, 23; Sayre et al. 2001.

<sup>731</sup> Stos-Gale et al. 1998, 119-20; Pulak 2001, 23.

CHAPTER VI

SOURCING COPPER: LEAD ISOTOPE AND TRACE ELEMENT  
ANALYSES OF COPPER INGOTS AND OTHER BRONZE AGE  
COPPER AND BRONZE ARTIFACTS

Trace element and lead isotope analyses have been two of the most important methods developed for the research of the Bronze Age copper trade.<sup>732</sup> Trace element analyses have been used on metal artifacts to determine a metal object's elemental composition and, in some cases, to provide information on the source of the metal and the technological process used to make the object. While useful in some cases, trace element data is less likely to provide evidence on an artifact's provenience when impurities typical of a particular ore deposit have been removed. Early attempts to identify the sources of specific samples of copper based exclusively on trace elements in the copper have provided important information on ore sources and metallurgical technology, but have not been unequivocally successful in identifying the provenience

---

<sup>732</sup> I refer to several types of analyses of metal artifacts and slag in the text. Metallographic examinations involve the preparation of a microscopic thin section from the sampled metal in order to view the microscopic structure of the metal. This will provide important information on the conditions in which the metal was formed, major impurities, and the technological processes involved in preparing it (e.g., smelting conditions, rate of cooling, evidence of physical treatments such as annealing, etc.). A variety of methods are used to determine the chemical composition of metal artifacts; these include neutron activation analysis, proton-induced X-ray emission (PIXE), atomic absorption spectrometry (AAS), X-ray fluorescence (see Renfrew and Bahn 1996, 324-5, 342-50 for an introduction to these analytical methods). I have not attempted to distinguish between these methods in the text unless a discussion of a particular methods' capabilities or accuracy significantly affects the interpretation of data on Bronze Age production or trade (as in the case of lead isotope analysis).

of ancient metal artifacts.<sup>733</sup> Lead isotope analysis has been more successful in determining the sources of ancient metals, although in some cases the results and interpretation of data have been controversial. Unlike most elements in metal ores, the proportions of three of four known radioactive lead isotopes, <sup>204</sup>Pb, <sup>206</sup>Pb, <sup>207</sup>Pb, and <sup>208</sup>Pb, are unaffected by metallurgical operations such as smelting and ores and remelting metals.<sup>734</sup> ‘Primordial lead’ (<sup>204</sup>Pb) has an extremely long half-life and was already present at the time of the formation of the earth, while the other three isotopes are produced by the radioactive decay of uranium and thorium. These isotopes were formed during the formation of the ore deposit and, like carbon-14, decay at a fixed rate which can be used to measure their age.<sup>735</sup> Since each ore body is typically formed in a different geological time period, the source of a specific metal can often be determined by the ratio of uranium and thorium to the different radiogenic lead

<sup>733</sup> Gale and Stos-Gale 1987b, 143; 1994, 98; Tylecote 1987b, 223; Budd et al. 1995a, 15-20, 24-5; Pernicka 1999. Gale (1989, 252) and Stos-Gale et al. (1997, 109) have proposed that the ratio between gold and silver in oxhide ingots provide a supplementary method for identifying Cypriot copper, although they acknowledge that trace amounts of metals can vary widely within a single ore deposit and do not view the gold/silver ratio in oxhide ingots as being accurate enough to be considered an independent method for establishing the provenience of oxhide ingots (Stos-Gale et al. 1997, 109; Stos-Gale and Gale 1994, 98). Their measurement of gold/silver ratios in copper artifacts from Cyprus has also found that copper artifacts from the EC-MC II periods do not fall into the restricted field that gold and silver concentrations do in later artifacts; this may be due to a difference in the smelting techniques used, perhaps resulting from a switch from smelting oxide to sulfide ores (Stos-Gale and Gale 1994, 98). The analysis of levels of a single element in order to establish the provenience of an artifact is now discredited, and levels of many different elements are now measured (Stos-Gale and Gale 1994, 98); LoSchiavo et al. (1990) analyze eight different elements in copper ingots using atomic absorption analysis, while Primas and Pernicka (1998, 59), in their analysis of oxhide ingot fragments from the Oberwilflingen hoard from southern Germany, measure twelve. Some elements may not be accurate indicators of provenience or technological processes, however. Elements such as bismuth and arsenic are particularly volatile, while others (such as sulfur) are deliberately refined out of metal through certain processes or introduced through fluxes with different chemical compositions than the original ore (Gale 1989, 248-9; Stos-Gale and Gale 1994, 98). For one example of elements introduced into slag from slag, see the manganese content in some Roman period slags from Cyprus (Given and Knapp 2003, 168-9, 178; Koucky and Steinberg 1982b). These factors mean that many different elements should be examined in a trace element analysis and that some elements will provide more significant data than others (see, for example, Rehren 1991; see also Woodhead 1999, on recent attempts to measure copper isotopes as a sourcing method).

<sup>734</sup> Weeks 2003, 129; Gale 1999, 112.

isotopes--  $^{206}\text{Pb}$  and  $^{207}\text{Pb}$  are measured against the amount of  $^{238}\text{U}$  and  $^{235}\text{U}$  in the sample, respectively, and  $^{208}\text{Pb}$  is measured against  $^{232}\text{Th}$  in the sample-- as long as sufficient ore samples have been collected and analyzed and the metal to be sourced has not been mixed with metals from a different source or sources.<sup>736</sup> The amounts of these elements in a given sample of metal is measured using a thermal ionization mass spectrometer, which separates molecules of different masses in a vacuum using an electromagnetic field.<sup>737</sup> While much debate has occurred in the archaeological literature in the past twenty-five years on the effectiveness and capabilities of the technique and the results published by researchers, it is now widely accepted as an effective means of sourcing many ancient metal artifacts, given that certain preconditions are met.<sup>738</sup>

Lead isotope analysis has limitations. It cannot distinguish between ore or metal samples originating from widely separated deposits of similar ages. Fortunately, this has not been a major problem in research on Mediterranean and Near Eastern copper sources, since most major ore formations were formed in different geological periods.<sup>739</sup> The recycling of metals from different sources could affect lead isotope readings, particularly with alloys of metals from different sources, although how

---

<sup>735</sup> Weeks 2003, 129-30.

<sup>736</sup> Stos-Gale and Macdonald 1991, 251; Gale and Stos-Gale 1999, 270-1; Gale 1999, 113; Rapp 1999, 700.

<sup>737</sup> Stos-Gale and Gale 1994, 99-100. See also Renfrew and Bahn 1996, 347-50 for a brief introduction to this analytical method.

<sup>738</sup> Scaife et al. 1999, 122, 131-2; Budd et al. 1995a, 2-3; Joel et al. 1995, 47; Pernicka 1995; Muhly 1996, 48-9; Gale and Stos-Gale 1999, 267; Knapp and Kassianidou 2005, 227.

<sup>739</sup> Stos-Gale and Macdonald 1991, 251.

detrimental such mixing would be to lead isotope readings has been debated.<sup>740</sup> At worst, this could render lead isotope readings from an object useless. This is a real problem in analyzing finished objects; however, microscopic examination and trace element analyses of Bronze Age copper ingots has so far shown that all analyzed samples were made mostly if not entirely from smelted rather than remelted copper (see Chapter VII).<sup>741</sup>

Other debated issues revolve around the lead isotope ‘fields’ of specific copper sources. The size and specificity of lead isotope fields are determined by the number of ore samples recovered from a specific mine or copper source and how these samples group statistically.<sup>742</sup> Ideally, any ore body that may have been exploited in

---

<sup>740</sup> Stos-Gale and Macdonald 1991, 251; Budd et al. 1995a, 21-4; 1995b, 71-2; Stos-Gale and Gale 1994, 104-5; 1995; Pernicka 1995, 60-1. Budd et al. (1995a; 1999) point out the extensive evidence for recycling of metal in the Bronze Age as supporting the hypothesis that oxhide ingots were made of copper from a variety of sources; specifically, either that they were made from recycled objects into oxhide ingots, or, more likely, from smaller bun ingots of copper or matte from different sources (1995a, 21; 1995b, 72; Knapp 2000, 41-3, 46). Other scholars disagree, citing the extra effort required to remelt objects into oxhide ingots, the transport of large amounts of metal scrap on Bronze Age shipwrecks, and the results of metallographic analyses of oxhide ingots, which tend to support the view that they are smelted products, probably from a single source of copper; this in turn supports Gale’s attributions of lead isotope data tracing the copper in oxhide ingots to Cyprus, most often to the Apliki region (Muhly 1979, 92-5; Wheeler and Maddin 1980, 111-3; Joel et al. 1995, 52-3; Knapp 2000, 39-40, 42-3; Gale 2001, 114-7, 120-1, 125; Hauptmann et al. 2002, 18).

<sup>741</sup> Tylecote 1982, 94; Hauptmann et al. 2002, 17-8. The presence of particles of copper sulfide and slag fragments in many oxhide ingots that have undergone microscopic analysis tend to support this view. During the processing of copper sulfide ore, the sulfur is removed through roasting, since large amounts of sulfur have a detrimental effect on the quality of the metal; however, small amounts of sulfides typically remain (Muhly et al. 1977, 355-6; Muhly 1979, 92-5; Muhly et al. 1980, 91-3; Maddin et al. 1989, 99, 101; Lichardus et al. 2002, 166). Most of these residual sulfides will typically be oxidized during the remelting of the metal, though this process may take several steps. Therefore, ingots with many residual sulfide particles (sulfur will not dissolve in copper) are likely made primarily from smelted, partially refined, unmixed metal (Hauptmann et al. 2002, 18). Koucky and Steinberg (1982b, 153-4) point out, however, that sulfides in copper metal could have been absorbed through fluxes or from residual sulfur in oxide ores as well.

<sup>742</sup> Stos-Gale and Macdonald 1991, 249-51; Muhly 1995, 55.

the Bronze Age will be thoroughly sampled.<sup>743</sup> If an artifact's lead isotope signature falls outside the lead isotope field of a particular source, then it cannot have originated from that ore body; however, if it does fall into the lead isotope field of an ore body, then it is statistically likely (90% or more) to have come from that particular copper source, although theoretically it could come from a different ore source of the same age.<sup>744</sup> Thus "lead isotope analyses can make a negative statement with absolute certainty."<sup>745</sup> Often there is typically little variation in the lead isotope composition within a particular 'source' or ore body, although different deposits of similar geological age can have very similar lead isotope compositions; this occurs in copper-rich areas of Cyprus, for example, where several different ore sources are very similar in age.<sup>746</sup> The number of ore samples required to accurately characterize the lead isotope 'fingerprint' of an ore source may vary (and has been debated), depending on

---

<sup>743</sup> Stos-Gale and Macdonald 1991, 253-4; Budd et al. 1995a, 8-10.

<sup>744</sup> Gale 1999, 111; Stos-Gale and Gale 1994, 110-1; Joel et al. 1995, 49; Pernicka 1995, 61. Pulak (1997, 238) states that: "It should be kept in mind, however, that because it is nearly impossible to sample exhaustively all ore bodies from which a specific metal could be won, lead isotope analysis may be used only to exclude certain ore sources from a group of possible sources."

<sup>745</sup> Stos-Gale et al. 1986, 29. This aspect of lead isotope analysis has been interpreted in different ways; while Pernicka (1995, 61) states that "we have to realize that we have finally reached the point where one can only speak in terms of probabilities and not of firm assignments", Gale (1999, 111-2) is more certain of these results, stating that "It is largely a question of semantics to engage in arguments that lead isotope analyses can only exclude ore sources, and can at best establish only that an ore deposit is consistent with being the metal source for particular artefacts. If a set of copper artefacts have lead isotope compositions matching only one copper ore deposit, amongst the set of copper ore deposits which it is geographically/archaeologically reasonable to consider, the normal application of scientific method would lead to the conclusion that, in the present state of knowledge, those artefacts were made of copper from that deposit."

<sup>746</sup> Stos-Gale and MacDonald 1991, 250. According to Gale and Stos-Gale (1994, 100), certain copper deposits are more complex, due to the presence of comparatively large amounts of uranium or thorium in the deposit. The decomposition of these radioactive elements affect the formation of lead isotopes and can result in widely varying readings within a single deposit. Copper deposits at Ergani Maden in Turkey, at Rudna Glavna in Yugoslavia, and in the Timna/Feinan region of the Sinai and Jordan are affected by this process; all are known to have been exploited in the Bronze Age (Stos-Gale and Gale 1994, 102-3; Jovanović 1980; 1988; Hauptmann et al. 1989; Hauptmann et al. 1992, 16-20, 25-7).



the complexity of the geological formations.<sup>747</sup> At times, there may be slight overlaps of lead isotope fields of different ore deposits; samples falling within these overlaps could potentially come from either source.<sup>748</sup> As a result of these problems, the adequate identification of specific lead isotope fields for specific sources has also been a contentious issue in archaeometric research.<sup>749</sup> Recently Stos-Gale et al. (1997) have presented lead isotope fields for twenty-six specific ore deposits on Cyprus, divided into three axes ('Solea,' 'Limni,' and 'Larnaca') based on their geological ages.<sup>750</sup>

Another potential problem is the complete destruction of an ore source by later industrial activity. This is likely at deposits that have been exploited in modern times, such as large parts of the Troodos Massif on Cyprus and the Ergani Maden copper mines in southeastern Turkey.<sup>751</sup> However, lead isotopes are not affected by metallurgical activity due to their mass.<sup>752</sup> Therefore, the lead isotope composition of slag can also be determined as well as the lead isotope signature of a wide variety of minerals besides metal ores (for example, lead isotope samples can be obtained from the gossan above copper sulfide deposits).<sup>753</sup> Anomalous lead isotope results may be due to the exploitation of small metal deposits ignored by modern prospectors and miners. Frequently an ore source is exploited only as long as it is economically viable

---

<sup>747</sup> Stos-Gale 1993, 117.

<sup>748</sup> Stos-Gale 1993, 118, 124.

<sup>749</sup> Stos-Gale and MacDonald 1991, 251; Muhly 1995, 55; Budd et al. 1995a, 4-6; Gale 1999, 113-4.

<sup>750</sup> Stos-Gale et al. 1997, 85-6, 89-91; Budd et al. 1995b, 26.

<sup>751</sup> Rapp 1999, 701; Bruce 1937, 639-71; Given and Knapp 2003, 172, 177.

<sup>752</sup> Woodhead 1999, 136-7; Gale et al. 1996, 395-6.

<sup>753</sup> Stos-Gale and Gale 1994, 103.

by modern standards; this does not necessarily mean that it was not exploited in ancient times or that small ore deposits were not significant to ancient metallurgists.<sup>754</sup>

Another potential problem involves lead alloying. Lead, which was obtained from a variety of sources in the Bronze Age, could also have been deliberately added to copper or bronze objects. Lead additions to copper alloys increases their fluidity during casting and can lower the melting point of the alloy. For example, the addition of 25% lead to a tin bronze would lower the melting temperature of the alloy to around 800 degrees Celsius.<sup>755</sup> Lead does, however, soften the resulting alloy, making large additions of the metal unsuitable for the production of tools and edged weapons.<sup>756</sup>

Lead alloying has a long recorded history. Adding lead to copper to improve the fluidity of the molten metal is recorded in metallurgical treatises of the 16th century A.D.<sup>757</sup> This technique was also employed much earlier in bronze production in Late Bronze Age Britain and in the manufacture of leaded bronzes in northern Europe by c. 1100 B.C.<sup>758</sup> This technique has also been suggested as a possible use of abundant amounts of lead found at the Late Bronze Age/Early Iron Age (12th-eighth century B.C.) site of Nuraghe Santa Barbara on Sardinia, where fragments of hundreds of Nuragic period clay molds for tools, weapons, and ritual and votive objects, including

---

<sup>754</sup> Gale and Stos-Gale 1987b, 137, 139; Evely 2000, 332.

<sup>755</sup> Ogden 2000, 154.

<sup>756</sup> Ogden 2000, 154.

<sup>757</sup> Tylecote 1987a, 195.

<sup>758</sup> Tylecote 1962, 309-10; Pernicka 2003, 90-1.

elaborate *bronzetti* figurines, were found.<sup>759</sup> Lead is abundant on Sardinia, and was put to various uses throughout the Bronze Age; lead clamps were frequently used to repair broken pottery, for example.<sup>760</sup> Some Aegean and Sardinian objects consist of up to 1-3.8% lead, likely added deliberately during casting.<sup>761</sup> Adding lead to copper has also been proposed for Egyptian copper alloy objects from the New Kingdom period, which frequently contain 1-3 % lead in their composition and in some cases have been found to contain up to 25% lead in complex cast objects such as statuettes; lead may have been imported into Egypt as early as the Middle Kingdom.<sup>762</sup> Alloying of bronzes (as opposed to cupellation of silver from galena, which has been proposed) could account for the large amount of melted lead found in the North Palace at Ras Ibn

<sup>759</sup> Gallin and Tykot 1993, 336, 338. Lead was added to copper perhaps to remove impurities by forming a more fluid crucible slag; in the 16th century, it was also used as a way to remove gold and silver from copper; these elements more readily combine with lead and can be recovered by melting out the lead from impure cakes of copper at temperatures between 500-700 degrees Celsius (Tylecote 1987a, 195). The lead found at Nuraghe Santa Barbara was not used as an alloy in five copper-based objects which were analyzed using atomic absorption analysis (all five had a lead content of 0.37% or less); lead seems to have been plentiful and used on the site primarily for the mending of broken ceramic vessels. This relative abundance of lead at this foundry site opens the possibility that lead was used as an alloy in cast bronzes, but more analyses of artifacts from the site are necessary to establish this (Gallin and Tykot 1993, 343).

<sup>760</sup> LoSchiavo (2001, 140) writes that galena (a common silver/lead ore) is “geologically ubiquitous” on Sardinia, and was used in the Nuragic period “unsparingly” for pottery repairs, water channel linings, clamps between building stones, and fixing statues to stone pedestals. See also LoSchiavo 1986, 233, 238; Tylecote et al. 1984, 120-2; Massoli-Novelli 1986, 5; Gallin and Tykot 1993, 336; Valera and Valera 2003, 6-7; Fadda 2003, 136-7.

<sup>761</sup> Muhly 1985d, 78-9; Tylecote 1962, 308-9. Gale and Stos-Gale (1985, 84-5) question the results of the study quoted by Muhly, stating that the method of measuring the object’s lead content by optical emission spectroscopy is obsolete; in a test using atomic absorption analysis, the lead content of at least one of these objects was found to be far lower. Due to the nature of the segregation of lead in a copper casting, however, Muhly believes “no sampling technique (short of dissolving the entire artifact) will be able to deal with the lead segregation problem” (Muhly 1985d, 79). Gale and Stos-Gale (1985, 85, 97-9) also doubt that lead contents in copper and copper alloy objects from the Mediterranean Bronze Age are the result of deliberate alloying.

<sup>762</sup> Ogden 2000, 154-5; Wachsmann 1987, 53, Pl. LII: A.

Hani.<sup>763</sup> Stos-Gale and Macdonald (1991) rule out all objects with over 6% lead as deliberate alloys, a figure which is too high.<sup>764</sup>

However, this problem likely applies mainly to finished objects rather than raw material; lead percentages in oxhide ingots are typically very low, which supports an identification of their production in Cyprus, where there are no major lead deposits and very low trace amounts of lead in local copper ores.<sup>765</sup> If lead from an ore body with a different geological age from the copper were utilized, the lead isotope ‘fingerprint’ would be to mixture of the two sources. Stos-Gale (2000) and Begemann et al. (2001, 51), state that ‘mixing lines’ in lead isotope ratios, which consist of an average range of lead isotope analysis measurements in between the fields of the two mixed sources of metal, can be recognized in metal samples indicating if an object was made from a mixture of metals from two or more different sources.<sup>766</sup> Preliminary research on the detection of mixing metals from different sources suggests that it did not often occur.<sup>767</sup>

---

<sup>763</sup> Lagarce 1986, 90; Karageorghis and Demas 1988, 222. Other explanations for the presence of the lead at Ras Ibn Hani have been proposed, such as the use of lead plates on wooden doors and its use in the cupellation of silver (Lagarce 1986, 90; Karageorghis and Demas 1988, 222). The absence of litharge, a by-product of silver extraction from silver-rich lead, suggests that cupellation did not take place; litharge has been found at the Minoan sites of Ayia Irini on Kea and Akrotiri on Thera (Gale 1998, 740). Litharge can be converted back to lead under reducing conditions, but analyses of Bronze Age lead objects from the Aegean show high silver contents, indicating that this technology was unknown on these sites (Gale 1998, 740).

<sup>764</sup> Stos-Gale and Macdonald 1991, 251. Begemann et al. (2001) believe the 1-2% Pb found in many Nuragic bronzes may have been deliberately added to increase the fluidity of the molten metal during casting. This is particularly likely if Cypriot copper was used to produce these bronzes, since Cypriot copper contains extremely small amounts of lead; the sourcing of some Nuragic bronzes to local deposits could therefore be due to lead additions rather than the exploitation of local copper deposits (Begemann et al. 2001, 67-8, 74).

<sup>765</sup> Hauptmann et al. 2002, 14-5; Maddin 1989, 100; Stos-Gale and Gale 1994, 93.

<sup>766</sup> Stos-Gale 2000, 58.

<sup>767</sup> Stos-Gale 2000, 58.

Some plano-convex ingots from Late Bronze Age deposits in Sardinia also contain high levels of lead, which could have occurred naturally in local copper deposits, but may also have been added deliberately, according to some researchers.<sup>768</sup> Muhly (1996) has noted, the ‘Cypriot’ oxhide ingots on Sardinia do “not seem to have been used to make anything;” none of the analyzed finished artifacts from Sardinia (and very few from the Aegean) have lead isotope signatures consistent with the Cypriot lead isotope field.<sup>769</sup> Over thirty major lead-zinc deposits are known on Sardinia, particularly on the southwestern part of the island, however; in addition, some lead-zinc and copper deposits are known in eastern and northwestern Sardinia.<sup>770</sup> In a recent lead isotope and trace element analysis of forty ingot and forty-five artifact samples from Sardinia, Begemann et al. (2001) have noted that many of the artifacts and a single bun ingot fragment from Ittireddu (which includes an 11% tin content, indicating it was made from recycled bronze) have high lead contents, and that high lead contents correspond with anomalously low levels of trace elements and a different lead isotope signature from the ingots.<sup>771</sup> Similarly anomalous trace element and lead isotope results were obtained for four ingots from Bonnanaro as well; these ingots, as well as three ingot fragments from Pattada, have lead isotope signatures consistent with Sardinian ores.<sup>772</sup> Researchers have noted a puzzling discrepancy in lead isotope results between finished Sardinian bronzes from the Nuragic period,

---

<sup>768</sup> LoSchiavo et al. 1987, 182; 1990, 139, 153, 167.

<sup>769</sup> Muhly 1996, 48-9.

<sup>770</sup> Gale and Stos-Gale 1987b, 352-3.

<sup>771</sup> Begemann et al. 2001, 45, 51, 55.

<sup>772</sup> Begemann et al. 2001, 55, 57.

whose lead isotope signature is consistent with local ores, and the numerous oxhide ingots and ingot fragments on the island, which have lead isotope signatures consistent with Cypriot copper ores.<sup>773</sup> Begemann et al. (2001) believe that the most likely explanation for these results is that “the isotopic signature of the oxhide lead does not show up because extraneous lead, with a different lead isotope fingerprint, found its way into the bronzes where it now dominates”; the fact that the average lead content of the finished Sardinian bronzes is up to fifty times higher than the amount of lead in the oxhide ingots from the island supports this hypothesis.<sup>774</sup> The high lead content is variable, however, while the tin content in these bronzes is fairly regular, discounting the idea that the lead was an impurity in the tin used to make the bronze.<sup>775</sup> The addition of local lead in large amounts to Cypriot copper with extremely low amounts of lead could easily produce these results.<sup>776</sup> While Begemann et al. are reluctant to speculate on the reason or reasons for the deliberate addition of lead, Kassianidou states that it was deliberately to “facilitate... casting”, particularly in the case of complex casts such as the Cypriot four-sided stands; in a chemical analysis of four of these stands, one was found to contain 1.7-20% lead.<sup>777</sup>

Other elements may have been deliberately added to copper produced in the period as well. An understanding of the technological processes used in Bronze Age metallurgy is therefore vital when interpreting the results of trace element analyses; the amounts

---

<sup>773</sup> Begemann et al. 2001, 65-7.

<sup>774</sup> Begemann et al. 2001, 67.

<sup>775</sup> Begemann et al. 2001, 59, 66-8.

<sup>776</sup> Kassianidou 2001, 106-8.

<sup>777</sup> Kassianidou 2001, 106-7; Macnamara and Meeks 1987, 57-9.

of some impurities may be due to technological processes rather than impurities in the original metal ore.<sup>778</sup> For example, New Kingdom period ingots and slag from Timna have a much higher iron content than those from the Chalcolithic and Early Bronze Age; this may be due to a combination of factors, including more efficient smelting methods as well as the deliberate use of minerals containing iron as fluxes.<sup>779</sup> Other elements volatilize in certain conditions inside the furnace or by processes such as the dead-roasting of copper sulfide ores; arsenic levels in copper may be affected by roasting and conditions within the smelting furnace.<sup>780</sup> In periods in which arsenic bronze alloys were manufactured, arsenic may have been deliberately added to smelting charges in the form of arsenic-containing minerals.<sup>781</sup> Thus the amounts of certain elements in ancient copper and other metals may be the result of technological processes rather than the original content of the smelted ore.<sup>782</sup>

*Results of Lead Isotope and Trace Element Analyses of Bronze Age Mediterranean*

*Artifacts*

Studies of Early and Middle Bronze-Age copper and copper alloy objects from the Aegean indicate that several copper sources were utilized in this period. Analyses from the Early Minoan cemetery of Aghia Photia indicate that the dominant source of

<sup>778</sup> Stos-Gale and Gale 1994, 98-9.

<sup>779</sup> Rothenberg 1978, 9; Bachmann 1978, 21.

<sup>780</sup> Arsenic has a low vapor point, so it will be released into the atmosphere if it is not smelted under reducing conditions; variations in arsenic content in ancient arsenic bronzes may be due to conditions in the furnaces or by the amount of arsenic present or added to the smelt (Charles 1967, 24; Wheeler and Maddin 1980, 106; Stos-Gale and Gale 1994, 98). Charles (1967, 25) has suggested that the volatility of arsenic would have required deliberate selection of high-arsenic minerals to produce bronzes of up to 8% As.

<sup>781</sup> Rapp 1999, 702; Stos-Gale and Gale 1994, 97.

<sup>782</sup> Stos-Gale and Gale 1994, 98.

of copper was Kythnos in the Cyclades.<sup>783</sup> Z. Stos-Gale's lead isotope analyses of 45 weapons from EM-MM Crete were compared with 36 Cycladic and 42 Cypriot weapons in order to deduce their origins.<sup>784</sup> She interprets the results as indicating that a wide variety of copper ore sources were exploited, which fall into five main groups: Group 1 objects are about 90% consistent with copper ore from Laurion, Groups 2 and 3 with two isotope fields from Cycladic sources, either Kythnos ("Kythnos Low") or possibly northwest Turkey, and Siphnos, which has small copper occurrences ("Kythnos High"), Group 4 "is to some degree consistent with" Chrysostomos (a small copper deposit on Crete), or, less likely, Cyprus, and Group 5 most closely resembles copper ores from the Turkish Black Sea coast and Othrys Mountains.<sup>785</sup> Group 1 consists of five objects, with two possibly belonging to the Kythnian field; Groups 2 and 3 consist of twenty-nine objects<sup>786</sup>, Group 4 includes ten weapons from different sites; Stos-Gale suggests that their lead isotope signature could have also been produced by melting together copper from the Cyclades and Kure in northern Anatolia.<sup>787</sup> Stos-Gale states that the known copper deposits from the Cyclades are rather small but also relatively close together; therefore, mixing of ore or smelted copper from different sources is likely (Figure 23).<sup>788</sup> Group 5 consists of three objects

---

<sup>783</sup> Evely 2000, 335.

<sup>784</sup> Stos-Gale 1993, 120, 122-3.

<sup>785</sup> Stos-Gale 1993, 119-20, 124-5.

<sup>786</sup> Stos-Gale 1993, 120, 125. Stos-Gale states that the division between these two groups is "tentative", and based on the fact that "the 'Kythnos' field has a larger range of lead isotope ratios than usual for a single ore deposit"; she concludes that "Such a situation is only to be expected if we accept that ore from several islands was smelted on one or two of them and then exported to Crete. There must have been a certain amount of mixing of the metal from different deposits." However, "On the other hand the scatter of data is not so great as to suggest that there was much mixing of metal from distant and isotopically different sources" (Stos-Gale 1993, 125).

<sup>787</sup> Stos-Gale 1993, 124-5.

<sup>788</sup> Stos-Gale 1993, 127.



which “are of a rather mysterious origin”, but most closely resemble isotopically ore deposits of Kure on the Turkish Black Sea coast, and Othrys, in mainland Greece 200 km north of Athens.<sup>789</sup> Stos-Gale considers a Black Sea origin to be more likely.<sup>790</sup> These conclusions support the assertion that most copper for Early Minoan weapons was obtained from the Cyclades, according to Stos-Gale; small amounts may have come from Anatolia or Greece and local deposits in Crete as well.<sup>791</sup>

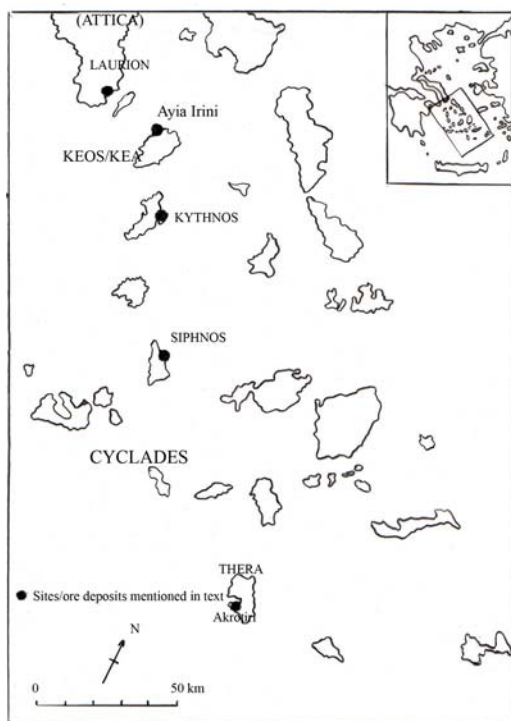

**Figure 23: Map of major metallurgical sites and ore deposits in the Bronze Age Cyclades (Modified from Broodbank 1993, 317).**

<sup>789</sup> Stos-Gale 1993, 124-5, 127.

<sup>790</sup> Stos-Gale 1993, 127.

<sup>791</sup> Stos-Gale 1993, 127.

Hundreds of ingots, including all of the complete copper oxhide and bun ingots from the Uluburun and Cape Gelidonya wrecks and many of the Uluburun tin ingots, have been analyzed using lead isotope analysis.<sup>792</sup> The earliest oxhide ingots analyzed, from Hagia Triadha, Tylissos, and Zakros on Crete (16th to 15th centuries B.C.) have lead-isotope signatures that are not consistent with ore sources on Cyprus or any other known ore sources in the Mediterranean or Near East, although there is a slight possibility that they could be from Anatolia.<sup>793</sup> Eight of the Hagia Triadha ingots analyzed come from a copper source formed in the Precambrian (approximately 640 million years old)-- one of the oxhide ingots from Zakros also has a lead isotope signature consistent with this source-- while the ninth comes from a different source (about 370 million years old), a source from which one of the oxhide ingots from Tylissos may have also originated.<sup>794</sup> Copper deposits in Cyprus are Cretaceous in date (no more than 100 million years old).<sup>795</sup> The Hagia Triadha ingots have lead isotope signatures consistent with those measured for metal objects from Troy, suggesting a common source, perhaps an as-yet unidentified source in Anatolia.<sup>796</sup> Some of this copper could have originated from ore sources in Afghanistan, where Precambrian copper deposits are known.<sup>797</sup> One oxhide ingot from Zakros and four ingot fragments from Gournia come from another unknown source, while another three of the six ingots from Zakros each come from three more unknown sources.<sup>798</sup> The archaeological contexts of these

---

<sup>792</sup> Gale 1999, 110.

<sup>793</sup> Gale and Stos-Gale 1987a, 140, 142-4, 156, 158, 161-2; 1988, 366, 372; 1999, 273; Gale 1999, 119.

<sup>794</sup> Knapp and Cherry 1994, 37; Stos-Gale and Gale 1990, 79.

<sup>795</sup> Gale and Stos-Gale 1987b, 140, 143; Tylecote et al. 1984, 119-22, 144; Gale and Stos-Gale 1988, 352; Muhly 1991, 190; Knapp and Cherry 1994, 37; Gale 1999, 112-3.

<sup>796</sup> Stos-Gale and Gale 1986, 99; 1990, 79.

<sup>797</sup> Stos-Gale et al. 1997, 107; Stos-Gale et al. 1998, 116.

<sup>798</sup> Stos-Gale and Gale 1990, 79.

ingots show them to be roughly contemporary with most of the Egyptian depictions of oxhide ingots. This is not surprising, since the shape of the early Minoan ingots is similar to many Egyptian representations of oxhide ingots.<sup>799</sup> The Kyme ingots, found off the coast of Euboea in Greece, also have this shape and may date to the same period; however, these ingots have been traced to Cypriot ore sources, most from the Apliki ore body.<sup>800</sup> A half ingot found at Hagia Triadha also has lead isotope ratios consistent with the Apliki ore body on Cyprus.<sup>801</sup>

It is extremely significant that the earliest securely dated oxhide ingot come from an unknown source or sources. This means that ingots of the oxhide ingot shape probably originated outside of the eastern Mediterranean (perhaps in the Near East) and certainly outside of Cyprus, which is most closely associated with the oxhide ingot shape in the Late Bronze Age.<sup>802</sup>

Copper and bronze materials from the LM IB Artisans' Quarter at Mochlos also produced varied results. Seventeen copper ingot fragments from the site (a few of which are identifiable as Type 1 oxhide ingots) all have lead isotope signatures consistent with Cypriot ore bodies; most are from the Apliki ores. Several are from the Skouriotissa mine, one is from Mavrovouni, and several have lead-isotope signatures from unidentified ore deposits within the Cypriot lead isotope field. Several of the latter have lead-isotope signatures matching slag found on Late Cypriot sites.<sup>803</sup> Some of these fragments are identifiable as pieces of oxhide ingots.<sup>804</sup> The fact that one

<sup>799</sup> Bass 1967, 62-7; Buchholz 1959, 32-4; 1988, 192; Evely 2000, 345.

<sup>800</sup> Demakopoulou 1998, 37; Buchholz 1959, 35-7; Gale 1999, 117.

<sup>801</sup> Soles and Stos-Gale 2004, 57.

<sup>802</sup> Muhly et al. 1988, 295.

<sup>803</sup> Soles et al. 2004, 46-7.

<sup>804</sup> Soles and Stos-Gale 2004, 54.

copper ingot fragment (IC.241) is possibly the corner of a Buchholz Type 1b ‘pillow’ ingot is significant. If correctly identified, then this would be the earliest known evidence of a ‘pillow’ ingot from Cyprus, and it is roughly contemporary with the earliest examples of oxhide ingots found on Crete.<sup>805</sup>

Casting waste and metal scrap from Building A in the Artisans’ Quarter had different origins. Of twelve samples analyzed, five came from Laurion, three from the Taurus Mountains of Anatolia, and four from Cyprus (two from the Apliki ore body, one from Skouriotissa, and one from an unknown source matching slag found at Enkomi).<sup>806</sup>

Several scrap bronze objects discovered in foundry hoards had lead-isotope signatures from a variety of sources; two bronze bowls and a piece of scrap copper probably originated in the Taurus Mountains.<sup>807</sup> One of five bun ingots from Arkalochori Cave on Crete is also from this region, showing that copper was sometimes exported from Anatolia to the Aegean in ingot form.<sup>808</sup> Soles and Stos-Gale suggest that copper, lead and other metals from the Taurus Mountains which appear in Bronze Age contexts were exported from the Cilician port of Ura, mentioned in Hittite and Ugaritic texts.<sup>809</sup>

Excavations at Kinnet Höyük near the Syrian border of Turkey recently uncovered Cypriot pottery that may have arrived there as part of a trade between Ugarit and the Bolkardağ region involving metals.<sup>810</sup> This trade may have primarily involved scrap metal; while much of the scrap copper and bronze metal from Mochlos and other Late Minoan sites have lead isotope ratios consistent with Laurion or the Bolkardağ region,

<sup>805</sup> Soles and Stos-Gale 2004, 46-7, Fig. 19. A tin ingot, an intact copper oxhide ingot and an oxhide ingot half with an incised mark were also discovered in LM IB (c. 1500 BC) contexts on Mochlos in 2004 (Whitley 2005, 102-3).

<sup>806</sup> Soles and Stos-Gale 2004, 48-9.

<sup>807</sup> Soles and Stos-Gale 2004, 50-1, 56.

<sup>808</sup> Soles and Stos-Gale 2004, 56.

<sup>809</sup> Soles and Stos-Gale 2004, 56.

<sup>810</sup> Soles and Stos-Gale 2004, 56.

the copper ingot fragments are all from Cyprus or unknown sources.<sup>811</sup> Lead contamination in the finished objects could also play a factor-- both Laurion and the Bolkardağ region produced lead used in the Late Bronze Age-- but in the case of some of the metal from Mochlos the lead content is probably too low for this to be the case.<sup>812</sup>

All of the oxhide ingots and ingot fragments from Cyprus that have been analyzed show lead-isotope signatures which are consistent with Cypriot ore bodies; Gale and Stos-Gale show that all those dating from post-1250 B.C. contexts can be traced specifically to the Apliki mining area in northwest Cyprus, although only about 15% of the finished bronze objects from Cyprus that have been analyzed come from this area, indicating that communities across Cyprus were supplying their own need for copper through the exploitation of local copper sources.<sup>813</sup> Lead isotope data indicates, according to Gale, that oxhide ingots from all periods divide into “at least three, or perhaps four, groups”, that the evidence for all post 1250 B.C. ingots cluster tightly together, and that these later results at least could not be the result of mixing smelted copper from several different sources.<sup>814</sup> These ingots date about three hundred years later than the Cretan examples and the Egyptian tomb paintings.<sup>815</sup> Similar results have been obtained from analysis of the oxhide ingot and ingot fragments from LH

<sup>811</sup> Soles and Stos-Gale 2004, 58.

<sup>812</sup> Soles and Stos-Gale 2004, 55-6.

<sup>813</sup> Gale 1999, 110; Gale and Stos-Gale 1999, 271; Gale 2001, 114-25. Gale (2001, 114-5) points out that the Apliki ore deposit includes the Late Bronze Age site of Apliki *Karamallos* but does not mean that all of the copper ore used to produce the oxhide ingots came from this site, since the Apliki ore body is significantly larger than the site.

<sup>814</sup> Gale 2001, 120-2. Gale states that a fair amount of variation in lead isotope composition exists between the different ore bodies on the island (p. 117); he also supports the hypothesis that oxhide ingots could have been cast in metallurgical installations such as those found in the coastal cities of Enkomi and Kition (p. 120-1). These settlements would have had to import copper from the interior or through maritime trade, perhaps from a variety of sources.

<sup>815</sup> Muhly 1996, 48; Karageorghis and Demas 1984, 57; Gale and Stos-Gale 1987b, 140.

IIIB Mycenae, from the probable wreck site at Kyme, Euboea, from ingots found in Bulgaria and on the Cape Gelidonya shipwreck, and ingots and ingot fragments from Boğazköy, Şarköy (on the Sea of Marmara), the Bay of Antalya, an ingot fragment from Emporio on Chios, fragments from Kommos and Gournia on Crete, and from Qantir in the Nile Delta.<sup>816</sup> Lead isotope data has allowed researchers to distinguish between several different ore bodies within Cyprus. Though significant copper deposits occur at Sha and Kalavassos, so far no Late Bronze Age copper-based artifacts from Cyprus, Crete, or Greece appear to match these deposits.<sup>817</sup>

A single bun ingot from the Cape Gelidonya shipwreck falls into an isotopic group known as the ‘El Amarna group’, since the highest number of copper-based artifacts with this isotopic composition were found at the Egyptian site of El Amarna.<sup>818</sup> Finished artifacts with the ‘El Amarna’ lead isotope composition are fairly common on Aegean and Cypriot Bronze Age sites, but the source of this copper is unknown; so far, no oxhide ingots have been found with the El Amarna lead isotope composition.<sup>819</sup>

The Uluburun shipwreck ingots, dating to the late 14th century B.C., show a slightly different lead-isotope signature; they are consistent with the Cypriot ore field as a whole but show a wider range of variation than the Gelidonya ingots.<sup>820</sup> Gale (2001) suggests that they were made of copper “from a different but as yet unknown copper

<sup>816</sup> Gale and Stos-Gale 1999, 272-3; Gale 2001, 123-5; Lichardus et al. 2002, 173-6; Kolb 2004, 592; Buchholz 2005, 152.

<sup>817</sup> Stos-Gale et al. 1998, 116.

<sup>818</sup> Stos-Gale et al. 1998, 117.

<sup>819</sup> Stos-Gale et al. 1998, 117.

<sup>820</sup> Gale and Stos-Gale 1999, 273. Five of the slab ingots from the Cape Gelidonya ship have lead-isotope signatures overlapping with lead isotope data for copper sources at Laurion rather than Cyprus, while the clover-shaped ingot and at least one bun ingot from the Uluburun wreck are from unknown sources (Gale and Stos-Gale 1999, 273; Stos-Gale et al. 1998, 117; Pulak 2000a, 150; 2001, 21).

source (probably Cypriot, but not Apliki); ” Stos-Gale et al. (1998) suggest the Phoenix mine, between the Apliki and Skouriotissa deposits, as a possible source.<sup>821</sup> A mixture of different sources within Cyprus is also possible; the lead isotope data for the Uluburun copper ingots shows slight overlaps with the ores from other Cypriot mining districts, such as Skouriotissa.<sup>822</sup> A single bun ingot and the clover-shaped ingot are consistent with a source at Laurion in Attica<sup>823</sup>; similar results were obtained for five of the slab ingots from the Cape Gelidonya ship.<sup>824</sup> The results of the lead isotope analysis of the Uluburun ingots may be due to the remelting of copper or copper matte collected from a wide range of sources in the Troodos, while the later copper exporters of the 13th century B.C. used the extremely rich but geographically more confined deposits at Apliki.<sup>825</sup> These results could then be interpreted as evidence for an increasing amount of centralization in copper production on Cyprus between the 14th and 13th centuries B.C. Unfortunately, there is little evidence for a major Late Cypriot center near Apliki, although some sites from the period have been identified (see Chapter VIII). *Toumba tou Skorou* may have been a major Late Cypriot city, but the site was largely destroyed by modern plowing and construction.<sup>826</sup> The lack of evidence for a major urban center near Apliki may indicate that copper exploitation in the Apliki mining region during the 13th century B.C. was controlled from a different part of the island, either from coastal centers such as Enkomi and Kition or one of several inland centers.<sup>827</sup> This interpretation is tentatively supported by lead isotope analyses of copper smelting slag from Enkomi and Kalavassos-*Ayios*

<sup>821</sup> Gale 2001, 125; Stos-Gale et al. 1998, 117-8.

<sup>822</sup> Hauptmann et al. 2002, 18; Pulak 2001, 20-1.

<sup>823</sup> See n. 331.

<sup>824</sup> Gale 1999, 118.

<sup>825</sup> Kassianidou 2001, 110.

<sup>826</sup> Vermeule and Wolsky 1990; Vermeule 1996, 50-1.

<sup>827</sup> Stos-Gale et al. 1998, 118.

*Dhimitrios*; analyzed slag from these sites are consistent with the source of the Uluburun copper ingots.<sup>828</sup>

At least four complete oxhide ingots and at least 95 ingot fragments are known from at least thirty separate sites on Sardinia,<sup>829</sup> as well as from Sicily (Cannatello and Thapsos) and the Aeolian islands (Lipari); although many of these were not discovered in archaeological excavations, those that were appear to date to the Italian Late Bronze Age and Early Iron Age (13<sup>th</sup>-10th centuries B.C.).<sup>830</sup> These ingots are therefore the most recent known in the Mediterranean, although their dates of manufacture, and in many cases the dates of their deposition remain uncertain.<sup>831</sup> Virtually all of these ingots have lead-isotope signatures consistent with Cypriot ore sources, although a large and vibrant local bronze industry was operating in the same period. At several sites, oxhide ingots presumably from Cyprus have been found with bun ingots and finished objects of Sardinian copper.<sup>832</sup> While Sardinian geology is fairly complex, most of the major copper ore deposits on the island are Cambrian rather than Cretaceous and, therefore, several hundred million years older than the

---

<sup>828</sup> Pulak 2001, 21.

<sup>829</sup> It is likely that a much larger number of complete oxhide ingots survived on Sardinia into the 19th and 20th centuries. For example, an unrecorded number of copper ‘stelae’ discovered at Assemmini in the 19th century were sold for scrap; other more recent finds of Nuragic foundry hoards have also been thoroughly looted (LoSchiavo et al. 1990, 19, 25, 29, 31). There are several more recent discoveries of oxhide ingots (see LoSchiavo 2005).

<sup>830</sup> LoSchiavo 1989, 33-6; 1995, 47; Muhly et al. 1988, 283; Stech 1989, 39; LoSchiavo et al. 1990, 19-33, 57, 71, 83, 101, 115, 125; Vagnetti 1999, 189. LoSchiavo (1998) and Vagnetti (1999, 189) list twenty-six sites; in her most recent article (2001), LoSchiavo presents a map with thirty unlabeled sites on which evidence for oxhide ingots have been discovered. An exact count of oxhide ingot fragments discovered on the island is difficult, since many ingot fragments in Late Bronze Age hoards could come from ingots of oxhide, plano-convex, or some other shape. In addition, many of the hoards and ingot finds from the island are poorly published, are chance finds, or are surviving objects from what were originally much larger scrap hoards (LoSchiavo et al. 1990, 19-33).

<sup>831</sup> Most have been found in poorly dated archaeological contexts, but are stylistically similar to Buchholz and Bass’ Types 2 and 3 ingots (see Appendix I).

<sup>832</sup> Gale and Stos-Gale 1987b 156, 158, 161-2; LoSchiavo 1989, 33-6.



copper deposits on Cyprus.<sup>833</sup> Only copper deposits in a few places could potentially overlap the Cypriot lead isotope field.<sup>834</sup> The significance of these copper sulfide deposits is debatable. While it is likely that they were exploited to some extent in the Nuragic period, they are almost completely played out today. LoSchiavo believes that major Sardinian copper ore sources had been exhausted by the Early Iron Age.<sup>835</sup> Stos-Gale and Gale note that copper deposits are “considerably less” abundant on Sardinia than on Cyprus.<sup>836</sup> Metallographic and trace element analyses of plano-convex and other ingot types from Sardinia also show significant differences. In some cases, these ingots have similar chemical compositions (particularly in the amounts of iron and arsenic in the metal), while in others the plano-convex ingots are far less pure than the copper oxide ingots, and contain significant amounts of other metals, particularly iron, zinc, and lead, all common mixtures in Sardinian ores.<sup>837</sup> As a group, these ingots tend to vary widely in the purity of copper contained in them as well.<sup>838</sup> A few plano-convex ingots contain significant amounts of tin, indicating that they could have been produced from recycled bronze objects.<sup>839</sup> The lead-isotope signatures of these ingots are also significantly different from analyzed oxide ingots, as are the results from analyses of finished bronze objects in Sardinian hoards; the bun ingots and finished

<sup>833</sup> Tylecote et al. 1984, 119-22, 144; Gale and Stos-Gale 1988, 352; Gale 1999, 112-3.

<sup>834</sup> Stos-Gale and Macdonald 1991, 256-7; Gale 1999, 112.

<sup>835</sup> LoSchiavo 2001, 139.

<sup>836</sup> Stos-Gale and Gale 1992, 320.

<sup>837</sup> LoSchiavo et al. 1987, 180-2; 1990, 57, 71, 77, 83, 101, 115, 125, 129, 153, 167, 175, 179; Tylecote et al. 1984, 119-22, 129-31, 144, 149. LoSchiavo et al. (1990) have published analyses of 95 oxide ingots and ingot fragments, as well as 25 plano-convex ingots, 18 ingot fragments of undetermined type (either oxide, plano-convex, or ‘flat’ ingots), as well as analyses of finished bronze artifacts from Sardinia. From the numbers, provided by LoSchiavo et al. (1990), an average purity of the copper ingots from Sardinia is 97%, while the average purity of the plano-convex ingots analyzed is about 90.7% (1990, 57, 71, 77, 83, 101, 115, 125, 129, 139, 153, 167). It may be significant that atomic absorption analyses of oxide ingots from Hagia Triadha and Zakros have produced evidence of lower degrees of purity (82-91.63%, with an average purity of 86.16% for the Hagia Triadha ingots, 17 of which were analyzed, and 88.55% for the Zakros ingots) (Mangou and Ioannou 2000, 213).

<sup>838</sup> Stech 1989, 39-40; see also Knapp 1990, 140.

<sup>839</sup> LoSchiavo et al. 1990, 177; Begemann et al. 2001, 51, 53.

objects are all consistent with local ores on Sardinia.<sup>840</sup> However, the discrepancy between the relatively homogenous lead-isotope composition of post-1250 B.C. oxhide ingots and the heterogeneous lead-isotope composition of copper and bronze artifacts analyzed from Sardinia, Cyprus, Greece, and other locations may indicate that many of these artifacts were produced from small local sources or were the result of extensive mixing and recycling. Oxhide ingots, on the other hand, which cannot be the result of recycling based on their metallic structure and lead-isotope signature, seem to have been made directly from smelted copper from one region if not one ore deposit.<sup>841</sup>

Stech notes that oxhide ingots rarely occur on sites alongside locally produced plano-convex ingots. She believes this evidence, as well as the variability in chemical composition of locally made Sardinian ingots, supports the view that Sardinian nuraghe were “communal, egalitarian, and essentially independent”:

Metalworking appears to have been a local enterprise, not controlled by any central administrative authority that encouraged uniformity in technique and product. Each nuraghe seems to have approached metalworking in its own way... Some groups probably did their own smelting of local ores, some bought oxhide ingots.<sup>842</sup>

The Sardinian oxhide ingots date mostly to a period when interregional trade in the eastern Mediterranean was otherwise declining, in the 12th and 11th centuries B.C. However, some of the most solid evidence for continued organized copper production on Cyprus occurs in this period, for example at Kition, where copper production at a significant scale continued in Area II (the “Temple Precinct”) into the 11th century

<sup>840</sup> Gale and Stos-Gale 1987b, 152, 155; 1988, 363; 2000, 60.

<sup>841</sup> Gale 1999, 110; 2001, 123-4; Muhly et al. 1980; Karageorghis and Kassianidou 1999, 185.

<sup>842</sup> Stech 1989, 41.

B.C.<sup>843</sup> Imports of gold, silver, and tin to Cyprus also continued, as shown by metal finds in contemporary tombs at Palaepaphos *Skales*; Kassianidou sees these imports as a possible reason for the continued trade with Sardinia.<sup>844</sup> However, most evidence of oxhide ingots occurs as ingot fragments in scrap hoards; Gale and Stos-Gale (1987b, 162) have pointed out that the total number of oxhide ingots and ingot fragments found on the island would represent the cargo of a single Bronze Age vessel the size of the Uluburun ship.<sup>845</sup> It may be the case that the total volume of copper export declined but that the oxhide ingot fragments in Sardinia were more frequently preserved for some reason; perhaps they were frequently left in votive deposits, or an intermittent supply of copper made the hoarding of copper a common practice. Frequent warfare could also explain why so many metal hoards were abandoned; perhaps many of the original owners were killed or driven off.

The need for Sardinian communities to import copper could perhaps be explained by the island's geography and the social organization of the island's population during this period. Over 7,000 *nuraghe*, or fortified towers with associated settlements, are known on the island today; many of these were occupied during the Bronze Age and Early Iron Age.<sup>846</sup> These are often located very close to each other-- on average about 0.6 per square kilometer, although in some areas this rises to 1.1, 1.3, and 2.2 per square km depending on terrain and other factors-- and seem to reflect dense settlement and a decentralized social order.<sup>847</sup> The frequency of fortifications on known sites of the period indicate that raids and warfare, at least on a small scale,

---

<sup>843</sup> Tylecote et al. 1984, 120-3; Sherratt 1994, 69-71; Karageorghis 1994, 5; Gale 1999, 112-3; Kassianidou 2001, 100; Hirschfield 2002, 98-9.

<sup>844</sup> Kassianidou 2001, 109.

<sup>845</sup> LoSchiavo 1989, 33-6; Gale and Stos-Gale 1987b, 162.

<sup>846</sup> Balmuth 1984, 23; LoSchiavo et al. 1990, 217; Blake 1997, 153.

<sup>847</sup> Harding 2000, 303; Becker 1980, 104-7; Trump 1992, 199.

were likely a constant threat in this period.<sup>848</sup> However, Rowland points out that the study of Nuragic period village sites has been sorely neglected; recent surveys have shown that many sites of the period apparently lacked fortifications or any close relation to a nuraghe.<sup>849</sup> Currently there is no evidence that the island was politically unified in the Late Bronze or early Iron Ages.<sup>850</sup> Despite the fact that significant metal deposits are found in several areas of the island, it might have made more sense for these communities to import copper from abroad, since it may have been available in much larger amounts than in overland trade. If imported copper was easily obtained, trading of oxhide ingot copper from the eastern Mediterranean would save the indigenous people the considerable effort of mining, smelting, and refining local ores, even in areas where they were abundant.<sup>851</sup> The savings in time, labor, and fuel could be enormous. In addition, oxhide ingots and ingot fragments have often been found in areas far inland on the island, showing that trade on some scale occurred between communities on different parts of the island.<sup>852</sup> It seems less likely that some sections of the island were blocked from access to Sardinian copper sources (hoards, often including oxhide ingots, are found all across the island); rather, the demand for copper in Sardinia was likely higher than Nuragic communities could easily produce. On the other hand, the Cypriot producers of oxhide ingots had been manufacturing copper for export at a large scale for at least a century and perhaps much longer. The social and economic organization of Cypriot copper producers may have been able to produce copper at a volume that the indigenous chiefdoms on the island may have been unable

---

<sup>848</sup> Harding 2000, 303.

<sup>849</sup> Rowland 2001, 39-41.

<sup>850</sup> Becker 1995, 104-5.

<sup>851</sup> Kassianidou 2001, 109-10.

<sup>852</sup> Gale 1991, 200, 213; LoSchiavo 1982, 271-2.

to match.<sup>853</sup> The goods exchanged for these metals are unknown. Several scholars have suggested that Cypriots traveled west to secure metals other than copper, especially tin from western Mediterranean sources, which may have become especially scarce after the c. 1200 BC collapse of states in the eastern Mediterranean.<sup>854</sup>

Many oxhide ingots and ingot fragments do not have secure archaeological contexts, which further complicates the issue.<sup>855</sup> However, judging from the archaeological contexts of oxhide ingot fragments and other bronzes from the Late Bronze and early Iron Ages discovered on the island, it is apparent that contact with the eastern Mediterranean, particularly Cyprus, played an important role in some Sardinian communities for at least a few decades in the 13th and 12th centuries B.C. This contact seems to have had a significant influence on Sardinian metallurgy, although the thriving metallurgical industry on the island during this period seems to have been developed by the indigenous people rather than foreign ‘colonizers.’<sup>856</sup>

Oxhide ingots may have been introduced during Sardinia’s Middle Bronze Age, as early as the 15th century B.C., in the same period in which the Nuragic towers began to be built.<sup>857</sup> However, the Cypriot influence in metallurgy is apparent in Sardinia primarily in the late second millennium B.C. (c. 1350-900 B.C.), in the finds of smithing tools, particularly ‘charcoal shovels’ and tongs, types found elsewhere in the

---

<sup>853</sup> Gale and Stos-Gale 1999, 272.

<sup>854</sup> LoSchiavo 2001, 141-2; Ridgway 1996, 118; Kassianidou 2001, 109.

<sup>855</sup> LoSchiavo 1989, 33-4.

<sup>856</sup> Vagnetti and LoSchiavo 1989, 227-31.

<sup>857</sup> Giardino 1992, 305. A copper hoard which included five oxhide ingot fragments was found in a stratified deposit at Sa Carcaredda-Villagrande Strisaili, a Nuragic ‘sacred well’ site. These date to the Recent Middle Bronze Age (c. 1600-1300 B.C.) (Rowland 2001, 53).

Mediterranean only on Cyprus.<sup>858</sup> Fragments of Cypriot-style tripods have also been found on the island as well as in Italy, and were later imitated by bronzeworkers in the central Mediterranean.<sup>859</sup> Some Nuragic tools show Cypriot influences, including tools that may have been used in mining.<sup>860</sup> Cypriot and Near Eastern bronze figurines may have helped to inspire the Nuragic industry in bronze figurines that flourished beginning in the later second millennium B.C.<sup>861</sup> The earliest piece of iron known from Sardinia was found at Nuraghe Antigori in association with a LC II (13th century B.C.) Cypriot sherd; LoSchiavo suggests that iron was introduced to Sardinia from Cyprus, which may have been one of the first major producers of smelted iron in the eastern Mediterranean.<sup>862</sup> Central European and Italian-style bronzes are relatively frequent in LM III contexts on Crete, indicating that central European metal objects may have been exchanged for eastern Mediterranean goods, particularly Mycenaean pottery, in this period as well, although the degree to which Cypriots, Minoans, Mycenaeans and the inhabitants of the central Mediterranean were involved in transporting these materials to Sardinia and southern Italy is unclear.<sup>863</sup> Eastern Mediterranean/Near Eastern (Asia Minor) and Aegean weight units may have even been in use in Sardinia by the end of the Bronze Age, according to a recent study of Late Bronze and early Iron Age balance weights from the island.<sup>864</sup>

A number of central Mediterranean finds in the Aegean, particularly on Crete, indicate Aegean involvement in trade with the central Mediterranean in the 13th to 11th

<sup>858</sup> Giardino 1992, 306; LoSchiavo et al. 1985, 9-56; Begemann et al. 2001, 50; LoSchiavo 2001, 131, 137, 139.

<sup>859</sup> Vagnetti and LoSchiavo 1989, 227-31; LoSchiavo et al. 1985, 35-50; Giardino 1992, 306-7.

<sup>860</sup> Giardino 1987, 199; 1992, 306.

<sup>861</sup> LoSchiavo et al. 1985, 52-62.

<sup>862</sup> LoSchiavo 1988, 102; Waldbaum 1982; Snodgrass 1982; Sherratt 1994.

<sup>863</sup> Hallager 1985; Bouzek 1985, 219-21; LoSchiavo 1988, 97-8, 101; Cline 1994b, 78-81.

<sup>864</sup> Ruiz-Gálvez 2003, 150-5.

centuries B.C., perhaps with some increasing Cypriot participation.<sup>865</sup> The known shipwrecks from the period (Uluburun, Cape Gelidonya, and Cape Iria) contain significant Cypriot cargoes.<sup>866</sup> Rutter views the port of Kommos with its extensive array of foreign imports as a likely port used by Cypriot traders, due to a long history and wider range of Cypriot imports at the site. These include pottery (both tablewares and bulk containers), copper ingot fragments, and even several Cypriot-style stone anchors reused as building material, the latter extremely rare in the Aegean.<sup>867</sup> Kommos probably served as a port for the nearby palatial centers of Ayia Triadha or Knossos during this period.<sup>868</sup> The Cypriot-style stone anchors are incorporated into the foundation of a LM IIIA2 building, perhaps used, as J. Rutter suggests, as a temple or sanctuary by a community of Cypriot expatriates; anchors were sometimes reused in a similar way in Cypriot and Syrian buildings, suggesting Levantine involvement in building the structure.<sup>869</sup> More unusual are the Italian-style imported pottery from the site, which divides into two groups, the first being thin-walled burnished vessels dating to the late 15th century B.C., and the second being several types of jars and bowls found in LM IIIB contexts.<sup>870</sup> The latter probably contained some sort of organic product.<sup>871</sup> Sardinian pottery has also been found at Cannatello in Sicily, indicating contact occurred between the two islands.<sup>872</sup> Canaanite jars, Cypriot, Cycladic, Egyptian, Mycenaean, and possibly Anatolian pottery were also found at the

<sup>865</sup> Cline 1994b, 79-80; Rutter 1999, 143, 145-7; Hirschfield 2001, 121; Shaw 2004, 43-4.

<sup>866</sup> Rutter 1999, 141, 147-8; Bass 1991, 75; Pulak 2001, 40-2; Kassianidou 2003, 115.

<sup>867</sup> Rutter 1999, 141, 147-8; Shaw and Blitzer 1983; Watrous 1992, 149-83; Shaw 2004, 43-6. Matthäus (2005, 349, Abb. 27) publishes a photograph of a 3-hole, Cypriot-style stone anchor in the Pula Museum in Cyprus, comparing it to similar anchors found at Ugarit and Larnaca. For a recent discussion of Bronze Age stone anchors, see Wachsmann 1998, 255-93.

<sup>868</sup> Rutter 1999, 140; Bachhuber 2006, 358-9.

<sup>869</sup> Rutter 1999, 141. *Foraminifera* fossils in these limestone anchors indicate a probable origin in Cyprus or coastal Syria (Rutter 1999, 141).

<sup>870</sup> Rutter 1999, 143-4; Watrous 1992, 163-9; Watrous et al. 1998.

<sup>871</sup> Rutter 1999, 144.

<sup>872</sup> Vagnetti 2001, 87-8.

site.<sup>873</sup> Rutter suggests that the Cypriot imports at Kommos, which have a longer history (dating back to the MM IB period) and a wider range (from bulk containers and tablewares to copper ingots and stone anchors) than other imports at the site, indicating that foreign trade with the port included a strong and perhaps dominant Cypriot presence.<sup>874</sup>

Mycenaean pottery is common on a number of central Mediterranean sites (over ninety with Aegean pottery are known) in central and southern Italy, Sicily, Sardinia, and smaller islands.<sup>875</sup> Cypriot pottery is much more scarce; it is most common in 14th and 13th century contexts on Sicily (Cannatello, Syracuse, and Thapsos on Sicily), and Nuraghe Antigori in southern Sardinia, a site that may have been a major center trade between the eastern and central Mediterranean.<sup>876</sup> Most date from contexts of the 13th century B.C. or later; Hirschfield (2001) has also identified three probable Cypriot-style incised marks on Mycenaean pottery sherds from Cannatello, which suggests the involvement of Cypriots in the export of Mycenaean pottery to the central Mediterranean.<sup>877</sup> The paucity of Cypriot pottery finds in comparison to Mycenaean and Minoan wares could also be due to a Mycenaean or Cretan dominance of the central Mediterranean maritime trade. Judging from the amounts of foreign imports (including Cypriot and Levantine pottery) found at the port of Kommos, a site which has “produced far more evidence for interregional contacts during the Final Palatial era than has any other single site on land in the Aegean,” at least some communities in

<sup>873</sup> Rutter 1999, 147-8, 167-86.

<sup>874</sup> Rutter 1999, 142-8; Shaw 2004.

<sup>875</sup> Vagnetti 1996; 2001, 87.

<sup>876</sup> Vagnetti and LoSchiavo 1989, 218-21; Vagnetti 2001, 77, 80-1.

<sup>877</sup> Hirschfield 2001, 121; Vagnetti and LoSchiavo 1989, 218-21. Examples of Mycenaean pottery found in Cyprus (see Hirschfield 2002) as well as smaller numbers in the Aegean, Egypt, and the Levant also have similar marks (Hirschfield 2001, 124).



Crete continued to be involved in maritime trade with the central Mediterranean<sup>878</sup>  
Another more likely explanation is simply that Mycenaean pottery came to be in demand, so it was exported by Aegean, Levantine, or Cypriot merchants (or a combination of all three). Mycenaean-style pottery was also widely copied by central Mediterranean potters, proof of its popularity in the region; an Aegean dominance of the trade is not necessary to explain the quantities of Aegean pottery in the central Mediterranean.<sup>879</sup>

The lack of Cypriot pottery in the central Mediterranean tends to detract from an argument for a Cypriot dominance in a metals-based trade with Sardinia, however. Perhaps Cypriot traders could have brought copper and other goods as far as Kommos or other Minoan or Mycenaean ports, after which Aegean traders could have transported it to the Mediterranean.<sup>880</sup> However, the fact that the metallurgical toolkit found on Sardinia so closely resembles Cypriot smithing tools and has little resemblance to smithing tools from elsewhere in the Mediterranean is a compelling argument for a direct Cypriot-Sardinian connection based on exchange of metals and metallurgical technology.<sup>881</sup> Perhaps the scarcity of Cypriot pottery is simply due to the fact that it was not in demand in the central Mediterranean. Cypriot ships traveling to the central Mediterranean could have stopped in Crete or the Aegean to pick up cargoes of Mycenaean pottery or other goods popular in the central Mediterranean, using ports like Kommos as resupply points along a trade route between Cyprus and Sardinia. Further support for this theory is perhaps lent by the relatively quick recovery of Cyprus after the c. 1200 B.C. collapse in comparison to other areas of the

---

<sup>878</sup> Rutter 1999, 140.

<sup>879</sup> Vagnetti 1996, 113-4.

<sup>880</sup> Hirschfield 2001, 126-7.

<sup>881</sup> LoSchiavo 2001, 139-42; Giardino 1992; Rowland 2001, 51.

Mediterranean. 12th- and 11th-century B.C. archaeological evidence from Sardinia indicates that oxhide ingots continue to be in widespread use on the island into the 11th century and perhaps later, although Mycenaean and Minoan pottery imports apparently ceased after the 12th century B.C.<sup>882</sup> This evidence seems to indicate continued contact at some level for almost two centuries after the end of the Bronze Age, though oxhide ingots may have been kept as raw material in founders' hoards long after they were manufactured and imported to Sardinia.<sup>883</sup> Perhaps the central Mediterranean trade was originally begun by Mycenaean traders in the 14th century B.C., when the earliest Aegean imports appear in the central Mediterranean, but became dominated in the 13th century B.C. by Cypriots.<sup>884</sup> Local Nuragic communities likely increased their participation in production and trade in order to exchange goods, including oxhide ingots, with eastern Mediterranean traders.<sup>885</sup>

The goods exchanged by Sardinians for eastern Mediterranean imports are not apparent, however. Metals have been proposed as a possible trade item, including tin from western Mediterranean deposits in Spain or Cornwall or the small tin sources on the island itself, or silver, gold, or iron in exchange for eastern Mediterranean copper.<sup>886</sup> Finds of western Mediterranean-style metal objects in Sardinian hoards indicate that at least indirect contact took place between Sardinia and the Iberian Peninsula.<sup>887</sup> Luxury goods such as glass and ivory (imports which are found on the

<sup>882</sup> Vagnetti 1996, 115; Stos-Gale and Gale 1992, 335; Ridgway 1996, 118; Kassianidou 2001, 99, 104.

<sup>883</sup> Kassianidou 2001, 105; Gale and Stos-Gale 1987a, 162.

<sup>884</sup> Kassianidou 2001, 109; Jones and Vagnetti 1991, 127-8; Vagnetti 1996, 109-112; LoSchiavo 2001, 139.

<sup>885</sup> LoSchiavo 2001, 142.

<sup>886</sup> Gale and Stos-Gale 1988, 382-3; Stos-Gale and Gale 1992, 336; Kassianidou 2001, 109.

<sup>887</sup> Giardino 1992, 308.

island); textiles and alum have also been proposed, or the exports could be some other perishable good.<sup>888</sup>

One more important question concerns the frequency with which oxhide ingot fragments are found on Sardinia. Sardinia has perhaps more widespread evidence for the use of oxhide ingots than any other region of the Mediterranean, including Cyprus, where they were likely produced. Over a hundred oxhide ingots (most fragmentary) have been found on Nuragic sites, none of which are consistent with Sardinian ores.<sup>889</sup> This fact has been used in the past to support the argument for production of oxhide ingots on Sardinia, either by indigenous groups or eastern Mediterranean colonists or prospectors, around the end of the Bronze Age. There is abundant evidence for a major indigenous metallurgy industry on the island, in the form of finished bronze objects, large numbers of steatite molds, and plano-convex ingots (of comparable quality to oxhide ingots, according to one study) which have chemical and lead isotope compositions consistent with Sardinian ore deposits.<sup>890</sup> The near absence of lead in the oxhide ingots from Sardinia is inconsistent with local Sardinian ores, which typically contain significant amounts of lead.<sup>891</sup> The results of lead isotope analyses of oxhide ingots have been cited as inaccurate by several scholars (for example, Muhly 1996, 48-9) because of this apparent discrepancy.<sup>892</sup> The religious and cultural practices of the Sardinians perhaps accounts for the large numbers of oxhide ingot finds and metal hoards in general on the island; in this respect, the islanders' cultural practices may resemble contemporary northern European cultures rather than those of

<sup>888</sup> Jones and Vagnetti 1991, 138-9.

<sup>889</sup> Stos-Gale 2000, 60.

<sup>890</sup> LoSchiavo et al. 1990; Becker 1980; 1984; Gale and Stos-Gale 1987a, 154-63; LoSchiavo 1988, 98-100; Stos-Gale 2000, 60; Begemann et al. 2001, 49-59, 73-4.

<sup>891</sup> Kassianidou 2001, 106.

<sup>892</sup> Kassianidou 2001, 105; Bass 1967, 77; LoSchiavo 1988, 97-8; LoSchiavo 2001, 142.

the eastern Mediterranean, where metal hoards are relatively rare and almost never consist of large metal deposits of a votive character.<sup>893</sup> Kassianidou points out the fragmentary nature of most oxhide ingot remains found on Sardinia, usually in metal hoards in association with scrap metal and fragments of bun ingots; so it is unlikely that they were kept as “status symbol[s]” or “prestige goods” “intended for elite exchange and... not as a convertible raw material” as some scholars have suggested.<sup>894</sup>

The political and social structure of the two islands must also play a role in how oxhide ingots were produced and distributed. It seems likely that the majority of oxhide ingots were produced expressly for export, although they could have also been used for copper and bronze goods manufactured near the copper mining and production sites. Cyprus, by the end of the Bronze Age, had developed a distinctly hierarchical settlement pattern (see Chapter VIII). Although the details of this hierarchy are still poorly understood, it is clear that major settlements such as Enkomi, Kition, Hala Sultan Tekke, and Kalavassos *Ayios Dhimitrios* required smaller satellite settlements to provide them with food and raw materials, including copper. Cypriot merchants may have chosen to export copper to the central Mediterranean because it was a high-value commodity that they could obtain in large amounts, due to the infrastructure that operated on Cyprus by the 13th century B.C.

<sup>893</sup> Knapp 1988, 150-2, 154, 167-71; Knapp et al. 1988, 235, 237-40, 248-9.

<sup>894</sup> Kassianidou 2001, 105; Stos-Gale and Gale 1992, 335; Steel 2004, 167; Lagarce and Lagarce 1996. Unlike LBA Cyprus, where oxhide ingots appear in bronze sculpture and as miniature ingots, Sardinia has produced no signs of an elevated status to these objects. Four miniature bun ingots, probably votives, were found at the Nuragic Sacred Well at Camposanto, Olmedo (Sassari) (LoSchiavo 2003, 124-6). Miniature replicas of objects, probably used for votive purposes, are common on Cyprus, but miniature oxhide ingots like those found on several eastern Mediterranean sites have not been found (LoSchiavo 1988, 102; 1998, 110; Rowland 2001, 48-9, 51).

Sardinia, by contrast, may have been politically fractured, as shown by the large numbers of fortified nuraghe, often in close proximity to each other, and evidence for a major population increase in the Late Bronze Age.<sup>895</sup> Although they certainly traded with their neighbors, each *nuraghe* was probably self-sufficient to a great extent. The frequency of fortifications shows that warfare or small-scale raiding was a constant threat, in contrast to the interior of Cyprus, where the rich but unfortified settlement such as Kalavassos *Ayios Dhimitrios* could be situated in an exposed and difficult-to-defend river valley.<sup>896</sup> Competition between Nuragic elites for the largest and most impressive displays of metalwork, or for the greatest number of gifts and votives to be awarded to their followers, gods, or neighboring elites could have also fueled the bronze manufacture of the period.<sup>897</sup> Interpreting the difference between Late Bronze Age Sardinian and Cypriot copper and bronze production as the difference between unsophisticated local production by primitive chiefdoms and organized, centralized, semi-industrial production by the Cypriots may be exaggerating the case; very similar economic and cultural factors seem to have affected metal production in both societies. Nonetheless, the proximity of Near Eastern cultures as well as geographical and geological factors such as the sheer size of the copper deposits in Cyprus, the relative lack of copper elsewhere in the region, and the location and size of the island probably led to the dominance of a more highly organized copper industry in Cyprus,

---

<sup>895</sup> LoSchiavo 2001, 134. Population for Late Bronze Age Sardinia are extremely sketchy, however, particularly due to the destruction of nuraghe for building stone and the lack of archaeological work on Nuragic village sites in comparison to “the largest elite residential-administrative centers” (Rowland 2001, 39-41). Many nuraghe are poorly dated, however, so conclusions based on their distribution must remain tentative (Rowland 2001, 38).

<sup>896</sup> Balmuth 1984; South 1989. Although estimates of Nuragic towers on the island run from 6-10,000, many villages were unfortified, and some were not located near nuraghi; to Rowland (2001, 40), this “forces a re-evaluation of the distinctive nature of nuragic culture: the existence of so many unprotected villages undermines the dominant view of bellicosity.”

<sup>897</sup> Such competition may have stimulated copper production on Cyprus earlier in the second millennium, where copper and bronze goods became important prestige goods, particularly for funerary displays (see Keswani 2005, 393-4).

even if Nuragic Sardinia still appears to have had one of the largest metallurgical industries of the late second millennium B.C.

The Sardinians were likely willing to accept copper in exchanges even if local copper sources on the island were exploited on a significant scale. The copper mines could have been in control of one or a few polities who controlled or limited access to metal to other groups. LoSchiavo suggests that copper sulfide ore deposits on Sardinia, which are almost mined out today, could have been exhausted in mining districts of Sardinia by the Early Iron Age.<sup>898</sup> This could have had major consequences for some communities on the island in that period, particularly if their access to local metal deposits was restricted by neighboring groups. Also, copper production entails a significant expenditure in time, labor, resources such as fuel, and takes considerable expertise to perform efficiently. There is no reason that anyone on Sardinia “would reject a shipment of ready to use metal,” though the presence of local copper supplies might lower the imported metal’s value.<sup>899</sup>

---

<sup>898</sup> LoSchiavo 2001, 139.

<sup>899</sup> Kassianidou 2001, 109-10.

## CHAPTER VII

### BRONZE AGE METALLURGICAL PRODUCTION AND THE MANUFACTURE OF COPPER INGOTS

The Uluburun ship's metal cargo provides the largest assemblage of known Late Bronze Age copper ingots from a single site in the Mediterranean. The surface features and chemical and physical properties of these ingots are important for several reasons. The metallographic and chemical composition provides important information on smelting and refining techniques in use in the period, as well as information potentially useful in the assigning the geographical origin of the metal.<sup>900</sup> This data is important for reconstructing the organization of ancient metal production and trade. Evidence for similarities in ingots' shapes, physical features, or chemical and metallographic features may point to degrees of standardization in production. The identification of reusable stone molds may be evidence of some degree of central control of copper production or of more intensive production activity in a particular area. Large numbers of ingots of uniform quality also suggest some centralized control of their quality, a standardization in smelting technology, or a widely accepted standard of purity for copper ingots; conversely, a range of ingot types and purities may be evidence of a more decentralized, competitive, or smaller-scale trade in metal.

---

<sup>900</sup> Stos-Gale and Gale 1994, 96-9.

*Ingot Composition and Evidence for Production Processes*

Chemically, both the oxhide and the bun ingots from the Uluburun ship are of highly pure copper-- typically 98-99% copper-- purities comparable to those of analyzed oxhide ingots from other Mediterranean sites, and much higher in purity than many other copper ingots from the Bronze Age, such as those produced in Sinai, the Caucasus, and Oman.<sup>901</sup> Trace element analyses of oxhide and bun ingots from both the Uluburun and Cape Gelidonya shipwrecks detected no significant differences between the compositions of oxhide and bun ingots on each ship.<sup>902</sup> Significantly, almost all of the bun ingots from Uluburun also have lead isotope signatures similar to the oxhide ingots from the ship's cargo, indicating that they were made from similar ore deposits, probably in the Troodos mountains of Cyprus.<sup>903</sup> However, analyzed oxhide ingots are also highly porous, and contain large amounts of slag inclusions and other impurities (particularly oxygen, derived from ore or the atmosphere, cuprite, which forms in a reducing atmosphere, sulfur, probably a residue left from the ore, and iron in slag inclusions)<sup>904</sup> This composition revises earlier interpretations of their use, in which plano-convex or bun ingots were the products of ore smelting, and were then

<sup>901</sup> Hauptmann et al. 2002, 13-4; Buchholz 1959, 28-37; Tylecote 1976, 158-9; 1982a, 94; 1987a, 195; Muhly et al. 1977, 357-8; Gale and Stos-Gale 1986, 89; LoSchiavo et al. 1987, 180-2, 184-5; Maddin 1989, 99-101; Rothenberg 1990, 75-7; Craddock 1995, 202. Late Bronze Age plano-convex ingots from Sardinia analyzed using atomic absorption analysis and SEM analysis show a greater range in purity, typically ranging from 81-99% copper, with a few more impure examples (21.3% and 72.4% Cu), the lower purities probably due to corrosion (LoSchiavo et al. 1990, 129, 139, 153). Ninety-five samples from Sardinian oxhide ingots analyzed using the same methods contain 87.6-99.6% copper, with an average purity of 97%; the thirty-four plano-convex ingots analyzed have an average purity of 88.5% (LoSchiavo et al. 1990, 57, 71, 77, 115, 129, 139, 153, 167). These were likely produced from local Sardinian ores; they contain more impurities, particularly of lead and iron, than are found in analyzed oxhide ingots. Lead isotope evidence also supports the hypothesis that these were typically made from different copper ore deposits (LoSchiavo et al. 1987, 182-5; 1990, 181-3, 203, 207; Gale and Stos-Gale 1987a, 161).

<sup>902</sup> Hauptmann et al. 2002, 18; Muhly et al. 1977, 357-8.

<sup>903</sup> Pulak 2000a, 147, 150; 2001, 19-22; Gale 2001, 119-20, 125. Two bun ingots have lead isotope signatures that deviate slightly from the Cypriot ore field, possibly indicating a different origin (Pulak 1998, 198; 2000a, 150).

<sup>904</sup> Hauptmann et al. 2002, 6-7, 12-4; Muhly et al. 1980, 90-3; Merkel 1986b, 265, 267; Begemann et al. 2001, 50; Lichardus et al. 2002, 166, 171-3.



refined and remelted to produce oxide ingots.<sup>905</sup> In fact, the bun ingots from the Uluburun ship have less sulfur than the oxide ingots, proving the oxide ingots could not have been made from bun ingots of this purity.<sup>906</sup> The theory that oxide ingots were sometimes made from bronze scrap is contradicted by the metallographic structure of the ingots; the extremely low levels of tin in the ingots, their highly porous structure (the result of impurities escaping as gases) and solid slag inclusions rule out scrap bronze as a major addition to the metal used to make the ingots.<sup>907</sup>

The slag inclusions in the ingots are also very significant. These indicate that the copper was not completely separated from slag adhering to it, a common result in the primary smelting of copper ore. However, such slag crusts can easily be removed by hammering, a concept which was likely understood by many ancient smelters based on archaeological as well as ethnographic evidence. Hence “There was apparently no interest in a thorough purification of the metal to remove these slag inclusions.”<sup>908</sup> The angular shape of slag inclusions indicate that the slag had solidified before the metal was remelted and cast, and that they had been only partially remelted.<sup>909</sup> If it had been tapped directly from a primary smelting used to melt copper ore rather than partially refined copper, as some scholars have proposed, then these slag inclusions would have been in the shape of small globules.<sup>910</sup> Large amounts of cuprite in the ingots, which cannot form in the oxidizing atmosphere needed to roast copper sulfide ores, also support this conclusion.<sup>911</sup> Although the presence of some of this mineral on exposed

---

<sup>905</sup> Budd et al. 1995b, 71; Hauptmann et al. 2002, 18.

<sup>906</sup> Hauptmann et al. 2002, 15.

<sup>907</sup> Hauptmann et al. 2002, 13, 18; Budd et al. 1995.

<sup>908</sup> Hauptmann et al. 2002, 7, 17.

<sup>909</sup> Hauptmann et al. 2002, 12.

<sup>910</sup> Hauptmann et al. 2002, 17; Tylecote 1976.

<sup>911</sup> Hauptmann et al. 2002, 12.

surfaces of the ingots is due to corrosion, Hauptmann et al. believe that the large amounts seen in metallographic sections are due to a “subsequent remelting process in a smaller reaction vessel, perhaps in a crucible which led to the precipitation of cuprite.”<sup>912</sup> They reconstruct the production of oxhide ingots as a two-step process: first, the primary ore is processed into matte, which is then further refined in a reducing atmosphere, perhaps in a crucible, and poured into the ingot mold.<sup>913</sup>

Mangou and Ioannou investigated the chemical composition of fifty-two Late Bronze Age ingots and the metallographic structure of twenty.<sup>914</sup> Oxygen (in the form of copper oxide) and copper sulfides were major impurities, indicating smelting from sulfide ores or oxide ores with residual sulfur and iron, probably also from the ore.<sup>915</sup> Slight differences in impurities were noted between ingots from mainland Greece and ingots from Crete, perhaps pointing to different origins or processing technologies.<sup>916</sup>

A cylindrical object interpreted as either a furnace bottom or a large crucible was discovered at Enkomi (Figure 24); it has a capacity of seventeen liters, and iron silicate slag was found on its inner surfaces; Hauptmann et al. interpret it as a crucible suitable for producing oxhide ingots such as those found at Uluburun.<sup>917</sup>

---

<sup>912</sup> Hauptmann et al. 2002, 12.

<sup>913</sup> Hauptmann et al. 2002, 17.

<sup>914</sup> Mangou and Ioannou 2000, 209.

<sup>915</sup> Mangou and Ioannou 2000, 210-2, 214.

<sup>916</sup> Mangou and Ioannou 2000, 212-4. See also Chapter V for the lead isotope results of Cretan ingots.

<sup>917</sup> Dikaios 1969:IIIa, Pl. 159, n. 20; Hauptmann et al. 2002, 17. Other scholars (Stech 1982, 105; Tylecote 1982a, 92; Muhly 1985b, 33) identify this object as the lining of a metallurgical furnace.

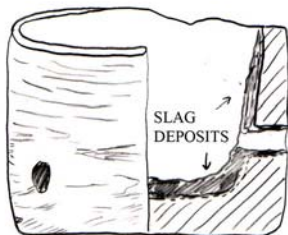

**Figure 24: Late Cypriot furnace lining or crucible from Enkomi (After Dikaios 1969: 3a, Pl. 139, n. 20).**

The contents of several such reaction vessels would be needed to produce an oxide ingot in several pours of metal. Hauptmann et al. note that in one core sample taken from an oxide ingot from Uluburun (KW 1548) “parts of dense copper alternate with those high in bubbles and cavities... and are sharply separated from each other. This could be caused by pouring several batches of metal into the mold to complete an ingot, an observation supported by macroscopic evidence.”<sup>918</sup>

The composition of the Uluburun ingots show that they were of a highly uniform quality but would have required additional refining before they could be used to cast finished objects.<sup>919</sup> The fact that further refining did not take place may indicate an economizing measure on the part of the ingot manufacturers; making partially refined rather than fully refined copper for export would save time, labor, and resources. Some of this may be due to technology of the period (for example, poling copper to reduce cuprite impurities may not have been invented yet), but a profit motive for manufacturing less pure copper ingots is entirely plausible, since slag inclusions could

<sup>918</sup> Hauptmann et al. 2002, 5; Pulak 1998, 196; 2000a, 142, Fig. 6.

<sup>919</sup> Hauptmann et al. 2002, 19.

be easily removed by hammering.<sup>920</sup> Some copper ingots of very high purity were produced in the Feinan region of Jordan in the Early Bronze Age, but these were extremely small in comparison to oxhide ingots. Additionally, the primitive smelting technology of the time, in which small copper prills collected in low-temperature smelting were collected and remelted in crucibles into larger ingots, would have eventually produced highly pure ingots but would have been a time-consuming process, impractical for the production of large ingots.<sup>921</sup> The nature of the ores smelted also plays an important role in composition; the sulfide ores smelted to produce oxhide ingots are much more difficult to purify than the oxide ores used at Feinan.<sup>922</sup> Impurities may have even been desirable for making the ingot more brittle, which facilitates its breaking up into the small pieces so often found in Bronze Age hoards; copper with fewer inclusions and impurities is much more difficult to break up.<sup>923</sup>

Analyses of copper oxhide ingot fragments show a dendritic structure in the copper, indicating that they cooled slowly, presumably in heated, well-insulated molds.<sup>924</sup> The direction of the dissipation of heat from the copper can often be determined in cast ingots, as J. Merkel's experimentally cast oxhide ingot showed very little columnar crystallization, probably due to a lower temperature in the copper when it was cast; the ingot was cast using a dry sand mold.<sup>925</sup> In core samples from the Uluburun oxhide ingots, Hauptmann *et. al.* saw relatively large grain sizes of copper, indicating a relatively slow cooling of the metal in a well-insulated mold; columnar characteristics

---

<sup>920</sup> Forbes 1964 9:20-1, 40-2; Mangou and Ioannou 2000, 212-3; Hauptmann *et al.* 2002, 6-7.

<sup>921</sup> Levy *et al.* 2002, 432; Hauptmann *et al.* 2002, 5, 18.

<sup>922</sup> Hauptmann *et al.* 1992; 2002, 5.

<sup>923</sup> Hauptmann *et al.* 2002, 3, 19; Merkel 1986b, 269.

<sup>924</sup> Tylecote 1982a, 94; see Evely 2000, 346.

<sup>925</sup> Merkel 1986a, 259.

“would be expected if the cooling had occurred in a mold material with a thermal conductivity greater than stone or earth.”<sup>926</sup> Similarly, the microscopic structure of oxhide ingot fragments from the Late Cypriot sites of *Maa-Palaeokastro* and *Pyla-Kokkinokremos* as well as oxhide ingots from Greece and Crete show a relatively large grain size, indicating a slow cooling process, perhaps because the ingot cooled slowly in a well-insulated stone, sand, or clay mold.<sup>927</sup> If the mold were made of a well-insulated material such as stone, earth, or clay, then slow cooling would have been a more likely result.<sup>928</sup>

*Evidence for Bronze-Age Metallurgical Installations and the Casting of Copper Ingots*

Analyses of the metallographic and chemical compositions of Bronze Age ingots provide important information on the conditions and processes by which Bronze Age ingots are produced; from these sources we know that ingots tended to be only partially refined and cooled slowly in well-insulated molds. These methods give an incomplete picture without comparison to archaeological evidence, however. Physical features on the surfaces of ingots, which provide information on casting techniques and the types of molds used for production can then also be compared with archaeological finds of furnaces, metallurgical equipment, and other archaeological evidence of copper production on archaeological sites.

The Uluburun ship provides the largest assemblage of copper ingots found from the Late Bronze Age. The Uluburun ship's copper cargo consisted of several types of ingots; the vast majority are oxhide ingots and plano-convex or 'bun' ingots. The

<sup>926</sup> Hauptmann et al. 2002, 6. Columnar structures were observed by Tylecote (1976, 166-7) in oxhide ingot fragments from Mathiati and Ayia Irini (Kea), however, indicating a more rapid cooling.

<sup>927</sup> Muhly and Maddin 1988, 471-2; Tylecote 1982a, 94; Mangou and Ioannou 2000, 215-6.

<sup>928</sup> Evely 2000, 355.

oxide ingots, of which 354 complete examples (thirty-six of the two-handled variety) were found, besides oxide ingot fragments. Over 121 complete plano-convex or 'bun' ingots were also found on the wreck, along with about four-dozen fragments representing perhaps another 10 to 15 ingots.<sup>929</sup> The plano-convex ingots are typically about 20-25 cm in diameter and weigh between 3 and 10.5 kg, with an average weight of 6.2 kg.<sup>930</sup> Most of the mold surfaces of these ingots are quite smooth, particularly in comparison with the oxide ingots.<sup>931</sup> Many of the bun ingots have mold siblings or possible mold siblings, indicating the use of reusable stone molds; in some cases a mold was used five or six times.<sup>932</sup> Over 30 different sets of mold siblings have so far been identified.

The physical features of the complete copper ingots from the Uluburun shipwreck closely resemble those of other copper oxide and bun ingots described in the archaeological literature; all of these are described as 'blister copper' due to the large blisters or gas porosity holes in their upper or 'rough' surface, caused by the escape of impurities in the form of gases from the copper metal.<sup>933</sup> The blistering on the upper or rough surfaces of the ingots indicates that they were cast in open one-piece molds. This is supported in some instances by the discovery of copper/copper oxide eutectic structures in the copper, which form only in an oxidizing atmosphere (i.e., an open mold exposed to air).<sup>934</sup> The 'mold surface' of an oxide ingot, which was in direct contact with the mold, is typically smoother, lacks blisters, and has smaller gas

<sup>929</sup> Pulak 2000a, 143-4; Yalçın et al. 2005, 569-71.

<sup>930</sup> Pulak 2000a, 143-4. The weights of ingots from saltwater sites are probably lower than the artifact's original weight due to corrosion of the metal (Pulak 2000a, 144).

<sup>931</sup> Pulak 2000a, 141.

<sup>932</sup> Pulak 2000a, 144. These mold groups have been identified by C. Pulak and members of the Uluburun excavation team over several years.

<sup>933</sup> Bass 1967; Muhly 1973a, 172; Tylecote 1982a, 94; Evely 2000, 328; Hauptmann et al. 2002, 4.

<sup>934</sup> Stech 1989, 40; Mangou and Ioannou 2000, 212-4.

porosities (holes made from escaping gases) in its surface. However, the texture of the mold surface and the number and size of the gas porosities may vary considerably between ingots. This is likely due to a number of factors, including the material or materials used to make the mold and the care taken in its manufacture, the porosity of the surface of the mold, the amount of moisture in the mold and atmosphere, and the amount of impurities in the molten copper.<sup>935</sup> The mold surfaces provide important information on how the copper ingots were cast, with larger pores and more regular surfaces possibly indicating the use of less porous clay or stone (?) molds, while identified mold siblings indicate the probable use of reusable stone molds.<sup>936</sup>

Five 'pillow' ingots of copper, which were also discovered on the Uluburun wreck have mold surfaces similar to those on the bun ingots.<sup>937</sup> These are considerably smaller than the other oxhide ingots, weighing between 6.772 and 10.966 kg.<sup>938</sup> Two pairs of these ingots are clearly mold siblings; they therefore must have been cast in

---

<sup>935</sup> Mangou and Ioannou 2000, 212-3. Hauptmann et al. (2002, 4-5) note that metallographic samples of copper ingots from Uluburun show that they are of a very high porous volume, but slightly more dense at the mold surface.

<sup>936</sup> Pulak 2000a, 141. Clay molds could perhaps have produced similar surfaces on the finished ingots, but would have probably been broken up after one use, unless perhaps charcoal dust, graphite, or some other material that could prevent the copper from fusing to the mold's surfaces was applied (Tylecote 1987a, 209). Vannoccio Biringuccio (1540) mentions the use of ash from burnt rams' horns in this capacity (Smith and Gnudi 1966, 253). Three pieces of graphite excavated from the 'Artisans' Quarter', a workshop area at the Minoan site of Mochlos, could have been used in a bronzeworker's workshop in the complex for this reason (Soles et al. 2004, 113). Clay molds, like stone, would have also been susceptible to damage from thermal shock. Tom Larson, a graduate student in the Nautical Archaeology program at Texas A&M University, is currently researching a masters' thesis on the manufacture of the copper bun ingots from the Uluburun wreck, which will involve the experimental replication of copper bun ingots. This research may provide more detailed information on how the surface features of bun ingots are produced.

<sup>937</sup> Pulak 2000a, 138, 141.

<sup>938</sup> The average dimensions of the five ingots are: length/minimum length: 31.7/27.5 cm; width/minimum width: 25.84/ 20.08 cm. The thicknesses of the ingots range from 2.0-4.3 cm.

reusable stone or clay molds.<sup>939</sup> The unique clover-shaped copper ingot (KW 1983) has similarly smooth mold surfaces.<sup>940</sup>

Two rectangular ingots and ingot fragments of different sizes were also found at Uluburun. These types are unusual in the eastern Mediterranean in comparison to oxhide and bun/plano-convex ingots, and the small collection on the Uluburun ship seem to be of several different types. One, KW 388, closely resembles the ‘pillow’ ingots in its size (30 cm long, 19.5-21.6 cm wide, approx. 2.7-4.0 cm thick), weight (9.584 kg), and slight protrusions at the corners of the ingot; therefore, it could perhaps be classified as a Buchholz Type 1b ‘pillow’ ingot (Figure 25).

---

<sup>939</sup> Pulak 2000a, 141. So far, no mold siblings have been identified among the four-handled Uluburun oxhide ingots; the conservation of the oxhide ingots has only recently been completed, so until recently the entire assemblage has not been available for comparative purposes. Unfortunately, due to the size of the assemblage, identifying mold siblings among the oxhide ingots will be extremely difficult. Only one possible mold sibling was found among the smaller group of two-handled oxhide ingots.

<sup>940</sup> See Yalçın et al. 2005, 568, n. 32, for a photograph of the mold surface of this ingot.



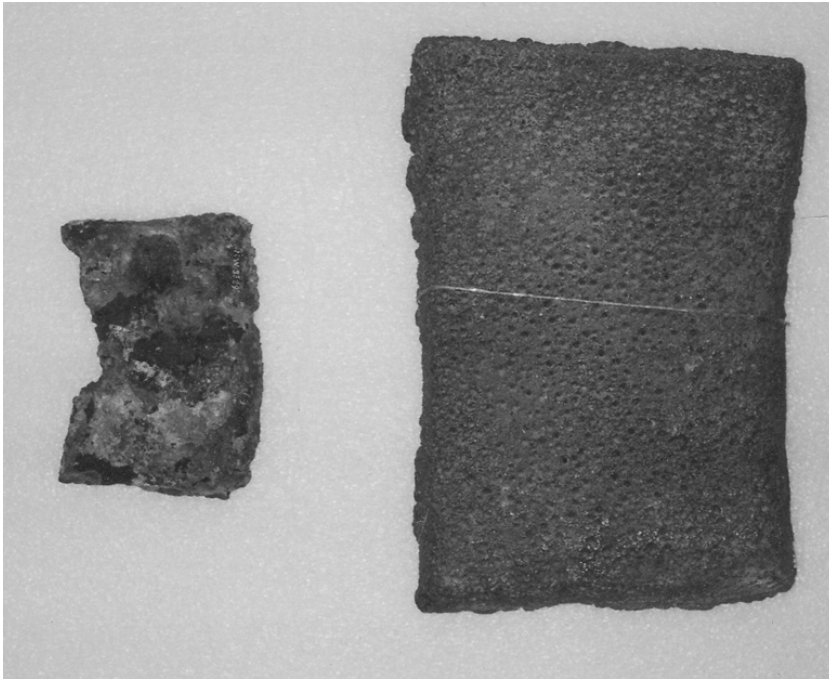

**Figure 25: Rectangular ingot fragment KW 3329 (left) and KW 388 (right), from the Uluburun shipwreck. The mold surfaces of both ingots are face-up (Photo by the author).**

There is at least one fragment of an ingot that clearly comes from a rectangular ingot. KW 3329 is approximately one-third to one-half of one of a rectangular ingot, 15.5 cm long (preserved length), 10.3 cm wide (original width), and ranging in thickness from 0.6-2.8 cm (Figure 25-6).



**Figure 26. Rough surface of KW 3329 (Photo by the author).**

The fragment weighs 1.3 kg; the original ingot probably weighed 3-4 kg. The mold surface is fairly smooth, with few, mostly large, gas porosity holes (indicating the use of a non-porous mold of stone or clay?) with sides beveled from the rough to the mold surface, while the rough surface has large blisters and deep depressions resembling those on oxhide ingots. A pronounced rim occurs along the edges of KW 3329's rough surface (Figure 26). A second ingot fragment probably also comes from a rectangular ingot.<sup>941</sup> Although only one original edge is preserved on this piece, the mold surface is slightly concave and very smooth, with few gas porosity holes; this indicates that the mold was carefully made, and that gases could easily escape from the molten metal. The mold surface and sides of this ingot resembles the mold surfaces of most of the plano-convex/bun ingots rather than those of the oxhide ingots. The fragment is also unusually thick (range of thickness: 3.9-4.2 cm), despite its small size (approx. 12.3 x 8.7 cm); it weighs 1.352 kg, and perhaps represents about one-fifth of the original ingot. Several other ingots fragments may have originally come from rectangular ingots, but could have easily come from other ingot types as well (bun or two-handled oxhide ingots). Unfortunately, none of these fragments have yet been sampled for lead isotope analysis to determine their origin

Five complete oval-shaped ingots and two halves of another oval-shaped ingot were included in the copper cargo as well. All six are mold siblings and have the same mark (see Figure 7).<sup>942</sup> These ingots weight between 8.6 and 9.1 kg (somewhat heavier than the other bun ingots, which are about 6.2 kg on average), and have very rough mold

---

<sup>941</sup> This ingot fragment is currently mislabeled 'KW 4495' in the storeroom of the Bodrum Museum.

<sup>942</sup> Pulak 2000a 144; Yalçın et al. 2005, 571, n. 45-6.

surfaces, indicating that the first in the series may have been tapped into a pit dug into the sand, clay, or soil and the ingot produced was subsequently pressed into sand or clay to produce additional ingot molds.<sup>943</sup> Alternately, multiple ingots may have been cast into a tapping pit adjacent to the furnace whose surfaces and shape survived several castings relatively intact. This group is evidently the output of a single team of smelters; all of the ingots have the same or highly similar incised secondary marks on them as well (see Chapter III).

In some sets of mold siblings the gradual deterioration of the stone molds is apparent; ingots cast earlier have a smoother mold surface while later ingots have more irregular mold surfaces, usually with a number of bulges or swells in it; these are likely due to increased spalling of the mold as a result of thermal shock from the repeated contact with molten copper.<sup>944</sup> In some cases, more damage to the molds is apparent on some members of a mold group than others, indicating that with each reuse the mold deteriorated more until they became unusable. In addition, at least two bun ingots (KW 512, KW 514) of the same mold group have small copper fins on the sides of their mold surfaces, possibly due to the flowing of molten metal into cracks in the mold.<sup>945</sup> The mold used to produce these ingots may have cracked, but seems to have been used several more times nonetheless.

The durability of stone molds would have depended on the type or types of stone used as well as the casting procedure. For example, in casting with modern stone molds, the

---

<sup>943</sup> Pulak 2000a, 143-4. This method of mold production was first suggested by C. Pulak in his excavation notes, and probably accounts for the features on the mold surfaces of the ovoid ingots and at least a few of the bun ingots.

<sup>944</sup> Damage from use may account for the spalling in the bottom and sides of the Ras Ibn Hani mold; see Muhly 2005, 504, Abb. 1 for a closeup photograph of the ingot mold's surfaces.

<sup>945</sup> C. Pulak, personal communication.

mold is first heated to 200-400 degrees Celsius in order to better resist the thermal shock of molten metal.<sup>946</sup> Clay molds are sometimes heated to higher temperatures—up to 600-700° Celsius, or even fully fired; besides decreasing the chance of major damage from thermal shock, this also drives out excess moisture from the mold.<sup>947</sup> Steatite and fine-grained sandstone (‘freestone’) are particularly suitable stones for the manufacture of molds.<sup>948</sup> Other types of stone are unsuitable or even dangerous; some limestones are too hard to work easily, while moisture contained within a porous limestone could convert to steam in contact with molten metal and break the mold.<sup>949</sup> Limestone will also gradually decompose at temperatures above 800 degrees Celsius.<sup>950</sup> However, many archaeological examples of limestone molds are known from the Bronze Age Mediterranean; the Ras Ibn Hani oxhide ingot mold was made of limestone.<sup>951</sup> Ancient metallurgists doubtless experimented until they found suitable materials for their purposes.

The vast majority of bun ingots seem to have been cast using reusable stone molds, although some may have been cast in cruder molds of sand, clay, or simply tapped into a depression in the ground. The manufacturing methods used for oxhide ingots are more difficult to assess, however. Their size indicates that they required a more complex refining and casting process, which still remain poorly understood.

---

<sup>946</sup> Tylecote 1987b, 220.

<sup>947</sup> Wang and Ottoway 2003, 35-6; Craddock et al. 1997, 1, 3.

<sup>948</sup> Tylecote 1987a, 219.

<sup>949</sup> Craddock et al. 1997, 1, 3; Tylecote 1987b, 219.

<sup>950</sup> Tylecote 1987a, 219-20.

<sup>951</sup> Craddock et al. 1997, 1; Catling 1964, 273-5; Lagarce 1986, 88; Buchholz 2003, 125-8, 130; Fasnacht 2005, 517, Abb. 2.

Excavated examples of Bronze Age furnaces indicate that they were generally quite small, averaging 30-50 cm in diameter and probably less than a meter high, although some were slightly larger.<sup>952</sup> In smelting experiments conducted with furnaces of this size, only a few kilograms of metal at most were produced; many scholars doubt that 30 kg of copper metal could have been produced in a single smelting operation.<sup>953</sup> These furnaces are generally considered to be far too small to melt up to 30 kg of copper in a single melt, although masses of up to 10 kg of copper could have been produced in known archaeological examples of Bronze Age furnaces.<sup>954</sup> However, Merkel replicated a copper oxide ingot weighing 25.1 kg by using a 50 cm high furnace with a 30 cm internal diameter which was continually charged with fuel and copper over an extended period; the ingot was cast using highly pure electrolytic copper (which would be more pure than ancient copper) and was cast into a sand mold.<sup>955</sup> It is likely that oxide ingots were produced by operating several furnaces simultaneously for these technological reasons, either by one or multiple pourings of metal from crucibles or, more likely, by tapping of molten metal from one or more furnaces. The superheating of larger masses of molten copper would have been required to increase the amount of time available for casting; in the case of casting smaller objects of copper or bronze, the metallurgist often has only a few seconds to pour the metal before it solidifies.<sup>956</sup> The New Kingdom period furnaces at Timna were capable of producing 3-4 kg copper ingots, so single furnaces of this size would probably not be capable of melting enough copper to produce an oxide ingot in one

<sup>952</sup> Rothenberg 1990, 5, 9, 22, 24; Tylecote and Boydell 1978, 29-31, 44; Merkel 1986, 251.

<sup>953</sup> Merkel 1986a, 254, 257; 1990, 100-2; Bamberger et al. 1986, 3, 1168-9; Budd et al. 1995b, 71; Hauptmann et al. 2002, 17. The mean weight of the bun ingots from the Uluburun shipwreck is 6.2 kg, while the mean weight for oxide ingots from the wreck is 23.9 kg (Pulak 2000a, 143).

<sup>954</sup> Hauptmann et al. 2002, 17.

<sup>955</sup> Merkel 1986a, 259; 1986b, 265-7. This ingot was far more pure than Bronze Age examples, however; the ancient ingots may have different properties due to the larger amounts of impurities.

<sup>956</sup> Tylecote 1962, 136.

pour; however, evidence for furnaces larger than these from the Bronze Age is elusive.<sup>957</sup> A possible clay furnace bottom about 20-25 cm in diameter and dating to the Late Cypriot period, has been recovered at Enkomi, however (Figure 27); Tylecote identifies it as more likely a smelting than a melting furnace, although a single furnace of this size would have probably been too small to cast an oxide ingot.<sup>958</sup> The slag from this furnace would have been tapped. An opening in the side of the furnace lining may have been used for this purpose, or used as an opening into which a tuyere could be inserted; other holes in the furnace lining could be a tap hole, or an accidentally produced hole caused by the corrosive effects of slag on the clay furnace lining (a 'breakout') (Figure 27).<sup>959</sup>

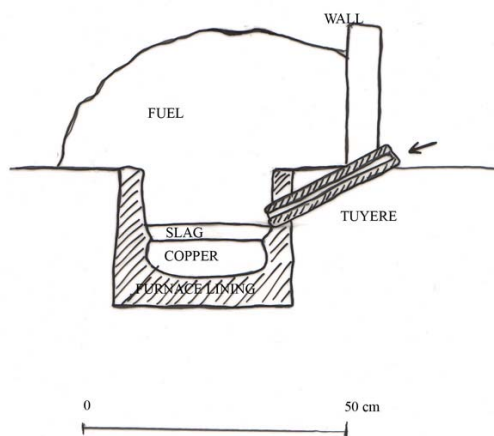

**Figure 27: Tylecote's reconstruction of the use of the Enkomi furnace lining (After Tylecote 1982a, 91).**

<sup>957</sup> Tylecote 1980, 190. See Table 2 for archaeological evidence for furnace dimensions and the construction of Bronze Age furnaces.

<sup>958</sup> Tylecote 1982a, 89, 91-2.

<sup>959</sup> Tylecote 1982a, 89, 91-2.

The melting of 30 kg of copper could have been accomplished in several ways.

Tylecote believed they could have been made with a single large furnace:

Surprisingly, there is no sign of a runner connecting the ingot with the furnace.<sup>960</sup> The ingots are far too big to have been cast from separate crucibles and the organization involved in separate crucible melts would be almost impossible. There is no doubt that these ingots have been made by tapping a whole furnace containing 30-40 kg of molten copper through an extended tap hole having some sort of launder system... The slag/metal volume ratio is such that the furnace would be of considerable size, certainly larger than those excavated at Timna (Israel). There is no question of allowing the furnace to fill up with metal as in the modern converter because it is impossible to keep a layer of molten metal in these furnaces when its thickness exceeds a few inches. The slag, however, would probably have to be tapped at regular intervals to minimize the distance between the tuyeres (the source of heat) and the molten copper.<sup>961</sup>

Unfortunately, no evidence of a furnace of this size has been found, and some scholars have argued that this reconstruction is too sophisticated to have been used for smelting in the Bronze Age.<sup>962</sup> Tylecote also assumes that oxhide ingots were made directly

<sup>960</sup> However, the channel on one of the ears of the Ras Ibn Hani mold could have served this purpose.

<sup>961</sup> Tylecote 1980, 195-6. Gale and Stos-Gale (1999, 269), agree, stating that Late Cypriot crucible/furnaces from Enkomi and Kition were capable of holding up to 30 kg of metal, and “still bear slag encrustations at the very height within them which corresponds to a charge of 30 kg. [of] metal” (269). It is possible, however, that Gale and Stos-Gale are including the fuel, fluxes, and possibly the ore (if these were smelting operations) in this calculation. One disadvantage of the smaller furnaces known to have been used in the Bronze Age was that they would have been more difficult to operate than larger furnaces: “As an enclosed volume becomes smaller the ratio of volume to enclosing surface decreases, and since heat generation takes place in a volume and heat is lost through enclosing walls,... a smaller furnace requires an increasingly larger heat input rate to maintain a desired temperature” (Rehder 1999, 312). A larger furnace would help offset these difficulties.

<sup>962</sup> Gale and Stos-Gale’s furnace reconstruction is large when compared with excavated Bronze Age furnaces, which tend to be about 30-45 cm in diameter with estimated heights of 70-100 cm (Merkel 1986, 251; Tylecote et al. 1976; Merkel 1990, 81, 84-5). Heights of Bronze Age furnaces are difficult to estimate, since most were destroyed after one or more smelts, or have eroded since their abandonment (Rothenberg 1990, 66-7). Merkel opposes the Gales’ reconstruction: “Based on the known remains of Late Bronze Age copper smelting furnaces, at Timna for example, thirty kilograms of copper would fill such a primitive furnace practically up to the level of the tuyeres. Thus, operation of the furnace for smelting and tapping 30 kg of copper would be extremely difficult and leave very little margin for error. This reconstruction is too sophisticated for what is currently known about operating parameters for Late Bronze Age shaft furnaces used for smelting” (Merkel 1986a, 257).

from smelted ore, which is likely not the case.<sup>963</sup> A more likely scenario involves the primary smelting of copper ore to produce matte, an impure copper containing large amounts of iron, sulfur, and other impurities; the matte could then be collected and remelted one or more times to produce the highly pure copper found in oxhide and plano-convex ingots from Uluburun, Cape Gelidonya, and various other Bronze Age sites.<sup>964</sup> This reconstruction better matches the archaeological evidence of Bronze Age smelting on Cyprus (see Chapter VIII), and could also explain how the small size of excavated Bronze Age furnaces could have been used to melt up to 30-40 kg of copper in oxhide ingots. According to Evely, the smelting of copper requires far more energy than the melting of highly pure copper, even though a higher temperature is required to melt pure copper than copper mixed with the impurities found in copper ore.<sup>965</sup> Therefore, one or a few melting (rather than smelting) furnaces of similar dimensions to those found at Timna could perhaps provide enough molten copper to cast a complete oxhide ingot.

If a large single furnace of the size proposed by Tylecote was not used, and smaller furnaces such as the furnace/crucible from Enkomi were not capable or not routinely used to melt the copper for oxhide ingots, then two other options are also possible. Multiple crucibles could have been used to melt partially refined copper and pour the molten metal into ingot molds, as proposed by Pulak (“It is not known whether oxhide ingots were cast from a single batch of molten metal contained in a large crucible holding some 30 kg of copper or by multiple pours from a number of smaller

<sup>963</sup> Tylecote 1977, 317.

<sup>964</sup> Stech et al. 1985, 398-9; Tylecote 1982a, 87; Soles and Stos-Gale 2004, 55.

<sup>965</sup> Evely 2000, 333: “One advantage that working with a ‘pure’ metal does bestow is the dramatic reduction in the amount of heat required to melt it; a mere 180 or so KCal are needed per kilogram of molten metal produced, as opposed to 1400 KCal when starting with a *high* grade oxide. The less pure the ore, the more the ratio increases.”



crucibles”) and Hauptmann et al., or, several smaller furnaces could have been used to melt partially refined copper and tap it into a mold by some sort of channel or launder system.<sup>966</sup>

Tylecote’s objections to the difficulties involved in handling crucibles are valid. He notes that most Bronze Age crucible finds from northern Europe tend to be very small, having a capacity of 20-100 cc; in order to have cast some of the larger objects known from the period, which weigh 5-6 lbs (approximately 2.27-2.73 kg), would have required much larger crucibles with capacities of 300-350 cc or else the simultaneous pouring of several smaller crucibles into the mold.<sup>967</sup> Crucibles of this small size may have been handled with withies wrapped around the rim of the vessel, as seen in the 15th century B.C. Tomb of Rekhmire, or with tongs or some other type of handle.<sup>968</sup> Most crucibles known from the period are fairly small, rarely exceeding 10-20 cm in diameter; either many crucibles of this size were used to pour molten copper into ingot molds or, more likely, the surviving examples (many of which seem to come from ancient smithies rather than smelting sites) were intended for use in casting small, finished objects rather than large ingots.<sup>969</sup> The simultaneous handling by several bronzesmiths of a few crucibles of this size for casting a small object is plausible, but they are completely inadequate for the production of oxhide ingots. Large crucibles would be more difficult to handle, as Tylecote points out. However, several methods

<sup>966</sup> Pulak 2000a, 141; Hauptmann et al. 2002, 17.

<sup>967</sup> Tylecote 1962, 135.

<sup>968</sup> Tylecote 1962, 135-6. The bronze casters in the Tomb of Rekhmire are casting a large bronze door in a mold “with no less than seventeen vents” using many small crucibles (Davies 1973, 53, Pl. LII). Davies (1973, 53) considers this scene to be an incorrect representation of the casting process; “This presentation is little likely to be even approximately correct, since a complete bronze door of any size would scarcely be attempted in one casting, nor has any such been found. What would be cast is the heavy pivot and its fitting for the top, and the still heavier angle piece and pivot for the bottom.” It is possible that the Egyptian artist who painted the scene was familiar with the metallurgical equipment and procedures of small-scale bronze casting, but had never seen the operation he was depicting.

<sup>969</sup> Evely 2000, 346-52; Hakulin 2004, 58-9.

seem to have been devised in the Bronze Age Near East for handling large crucibles, in some cases for crucibles with capacities of up to 7.6 kg.<sup>970</sup> For example, some eastern Mediterranean crucibles have grooves on their undersides; these may have been for the insertion of a bar for tilting the crucible rather than lifting it, a more dangerous and awkward maneuver.<sup>971</sup> Crucibles from the Babylonian site of Tell edh-Dhiba'i had tap holes in their bottoms, which would have been kept plugged until the metal was melted; then the plug was breached and the metal was drained directly into a covered mold below the crucible.<sup>972</sup> Similar crucibles were in use in Egypt and the Sinai.<sup>973</sup> Perhaps crucibles of this size could be placed in pits, the metal melted in them, and then their contents tilted into an ingot mold.

---

<sup>970</sup> Tylecote 1982b, 231-2; Petrie 1906.

<sup>971</sup> Tylecote 1982b, 231-2. Crucible fragments are common on Bronze Age metallurgical sites. See Evely 2000, 346-52, and Hakulin 2004, 58-9, for catalogs and dimensions of Minoan crucibles. For other sources on Bronze Age crucibles from the eastern Mediterranean, see Branigan 1974; Öbrink 1979, 3, 142; Tylecote 1982a; 1982b; Cummer and Schofield 1984; Pusch 1990, p. 89 (Abb. 7); Blitzer 1995, 504-7, Pl. 8.76-8; Yener et al. 2003, 186; Hakulin 2004.

<sup>972</sup> Davey 1988, 64-5.

<sup>973</sup> Davey 1988, 64; Tylecote 1982b, 232; Petrie 1906. Nibbi (1987, 27) identifies Egyptian crucibles of very similar shape to the Tel edh-Dhiba'i crucible (Nibbi 1987, 24, 27). Other similarly-shaped terracotta objects from Egypt, often called "pig-faced pots," also show examples of burning, but are most likely pot bellows (Nibbi 1987, 14-5, 17, 19-27).

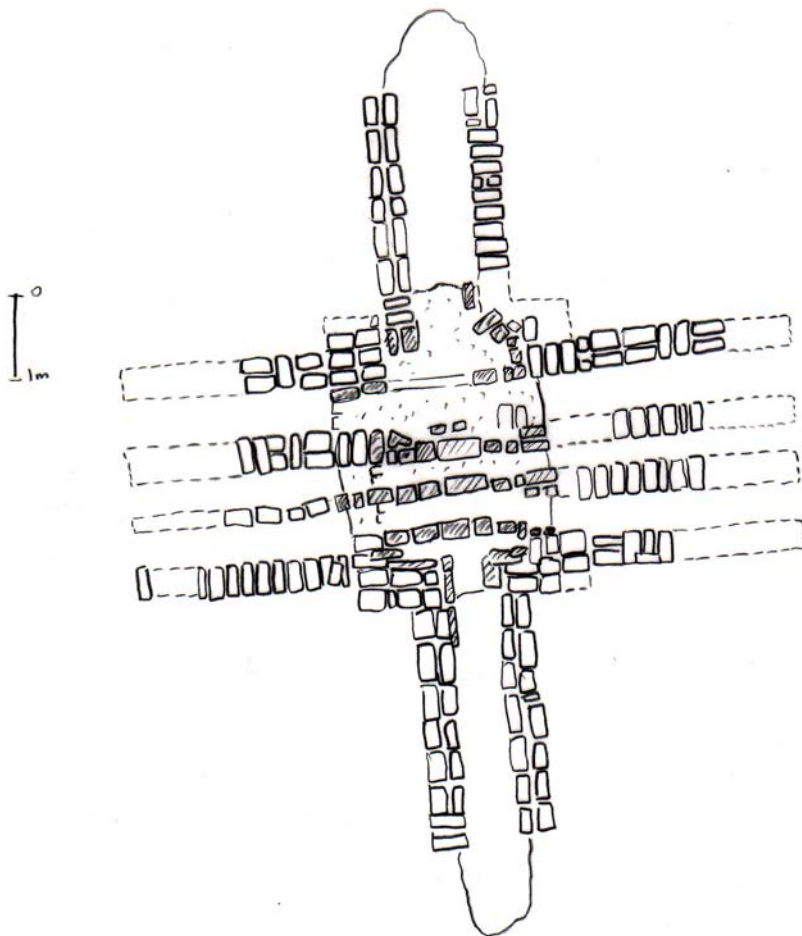

Figure 28: Plan of cruciform furnace from Qantir, 13th century BC (After Pusch 1995, Figure 2).

The use of crucible furnaces was common in the Bronze Age; however, these were typically for small-scale smelting, refining, and casting rather than for large-scale primary smelting and refining.<sup>974</sup> There are exceptions, however, even in the Late Bronze Age when larger furnaces were more common. Metallurgical installations at Qantir in the Nile Delta, dating to the 13th century B.C. (c. 1310-1250 B.C.), show how a large-scale smelting installation based on crucible furnaces may have appeared

<sup>974</sup> Zwicker 1982, 64; Yener 2000, 39; Hauptmann et al. 2002, 4-5, 7, 12.

(Figure 28).<sup>975</sup> This urban site, the capital of Ramesses II, included an area with metallurgical workshops on a massive scale. The facilities consisted of two parts. The first were a group of fifteen-meter long ‘melting channels’ of parallel rows of mudbrick into which tuyeres had been inserted, which were probably worked with pot bellows.<sup>976</sup> Slags adhering to the mudbricks, tuyeres, and crucibles verify that these were used for copper or bronze working; large amounts of bronze scrap, clay and stone (limestone and steatite) molds as well as a single oxhide ingot corner (the first found in Egypt) were also found in the area.<sup>977</sup> Casting pits were sunk into the sand between the walls of the ‘melting channels’ In another area were three large ‘cruciform’ furnaces, measuring approximately 9 x 6 m, built of mud brick in which several crucible furnaces, each partitioned from the other, could be operated simultaneously (Figure 25).<sup>978</sup> Such installations could melt a significant amount of copper for casting larger objects; although a crucible found on the site measured only about 15 cm in diameter, the facilities, if run simultaneously as the excavator suggests by “several hundred people,” could produce vast amounts of refined metal or finished bronze objects.<sup>979</sup> It seems unlikely that all of the melting and casting facilities would be run at once under normal circumstances, however.

No such evidence has been found in areas closer to ore sources, however, and the Qantir casting facilities are most likely a unique result of Egyptian state control of industry. However, large-scale results were sometimes achieved using fairly primitive technology. Tin was smelted at the sites of Göltepe and Kestel in the Taurus

---

<sup>975</sup> Pusch 1990, 78-81, 113; 1995, 126; Hauptmann 2005, 481-2; Schneider 2005, 232.

<sup>976</sup> Pusch 1995, 123.

<sup>977</sup> Pusch 1995, 123.

<sup>978</sup> Pusch 1990, 91; 1994, 152-3, 159; Ogden 2000, 167.

<sup>979</sup> Pusch 1990, 89; 1995, 123.

Mountains of Anatolia during the third millennium B.C. using a very primitive crucible smelting process; however, the fact that over one ton of vitrified crucible fragments as well as large amounts of other metallurgical debris at the site indicate large-scale exploitation using relatively primitive technology.<sup>980</sup> Although large-scale metal production was possible and sometimes occurred with crucible smelting technology does not mean that it was used in antiquity in copper oxide ingot production. While crucible remains are known from copper-rich areas in the eastern Mediterranean, copper furnaces seem to have been more commonly utilized. If crucibles were used in casting oxide ingots, they would probably be cast by pouring several smaller crucibles into the mold rather than one large crucible holding up to 30 kg, which would be extremely difficult to handle.<sup>981</sup> Huge numbers of crucible fragments would be expected at sites where ingot casting using crucibles was practiced at a significant scale. Such evidence has not been found. Fragments of fired clay used in metallurgical operations are found on industrial sites in Bronze Age contexts, particularly at Apliki, Enkomi, Kition, Kalavassos *Ayios-Dimitrios*, Timna, and other sites; however, it is usually unclear whether these are parts of crucibles, clay furnace linings, or the burnt inner layer of a furnace without linings.<sup>982</sup> Crucible clays, like clays used to construct furnace linings and some clay molds, are typically coarse in order to resist the thermal shock involved in handling molten metal. Tempers vary, but may include sand, organic material, ground stone, ash, slag, or other materials.<sup>983</sup> Bronze Age crucibles and furnace linings were frequently made with organic temper such as shell or grass, which burned out as it was fired; organic temper is known from furnace lining fragments from Politiko *Phorades* and in tuyeres from Site 2 at Timna,

---

<sup>980</sup> Yener et al. 2003, 185-7.

<sup>981</sup> Pulak 2000a, 141.

<sup>982</sup> Tylecote 1971, 53, 55; Stech 1982, 105, 107; Rothenberg 1990, 1.

<sup>983</sup> Smith and Gnudi 1966, 391; Freestone 1989, 157-8; Rothenberg 1990, 54, 56-7.

which were built with reeds between multiple layers of clay.<sup>984</sup> The EM ceramic smelting furnaces at Chrysokamino on Crete were tempered with chaff; in the case of clay molds, the burning out of such organic material in the temper of the clay makes it more porous, which allows gases to escape more easily.<sup>985</sup>

Archaeological evidence for Bronze Age ingot molds is even more problematic. Copper ingots could have been cast in several ways, using stone, clay (fired or unfired), sand, or other materials; some may have even been cast simply by tapping metal into a depression in the ground. Stone molds and fired clay molds are the easiest to identify and the most likely to survive in the archaeological record. Examples of steatite (soapstone) and double-faced reusable clay molds are known from central Africa; these were used to make ‘Katanga crosses,’ a type of copper ingot currency which was first produced between the seventh to ninth century A.D. and continued to evolve and circulate until the early 20th century.<sup>986</sup> Clay molds as well as molds of stone (particularly steatite) and bronze were in use to produce finished objects throughout the Bronze Age Mediterranean.<sup>987</sup> Stone ingot molds are rare, however. Dikaios identified two stone objects excavated at the Late Cypriot site of Enkomi as bun ingot molds.<sup>988</sup> However, these are more likely parts of stone pot bellows, based on the spout and opening on the bottom of the better preserved example; such an opening would have a tube inserted into it, which would lead to a tuyere in the wall of

<sup>984</sup> Given and Knapp 2003, 215; Rothenberg 1990, 36-7, 41, 74.

<sup>985</sup> Betancourt et al. 1999, 363; Wang and Ottoway 2003, 37.

<sup>986</sup> Denk 1995, 68-9, 71; de Maret 1995, 137-41.

<sup>987</sup> Evely 2000, 353-62; Catling 1964, 273-6; Branigan 1974, 77-83, Pl. 44; Becker 1984, 163-208; Giardino 1987, 221; Tylecote 1987a, 214-7; Hakulin 2004, 60-1. Steatite (soapstone) in particular was a common, high quality material for stone molds in Syria, Lebanon, and Sardinia, but is not native to Cyprus (Elliott 1984, 93; Becker 1984; Tylecote 1987a, 219).

<sup>988</sup> Dikaios 1969, 1:43; 1969, 3a:Pl. 8, n. 1, 3-4; 1971, 2:508, Pl. 127, n. 48-48a.

the furnace.<sup>989</sup> This reconstruction is more likely; these artifacts lack the rounded rims described by Rothenberg on the Timna bun ingot mold fragments, and do not have the beveled sides seen on most copper ingots, which would help in levering the ingot from the mold.<sup>990</sup> Large numbers of clay ingot mold fragments have also been recovered from the Early Bronze Age site of Khirbet Hamra Ifdan in the copper-rich Feinan region of southern Jordan. These molds were used to make small crescent-shaped ingots between c. 2700-2000 B.C.; the ingots were manufactured at a large scale at the site and exported.<sup>991</sup>

A single stone mold for oxhide ingots was found at the North Palace of Ras Ibn Hani, Syria. Unfortunately, even this evidence is ambiguous. The ingot mold is made from a fine-grained limestone block of a type of local shelly limestone known as *ramleh*.<sup>992</sup> It is 1.546 m long, 79.5 cm wide on its upper surface, and about 39 cm thick; the mold itself is carved 6-7.5 cm deep.<sup>993</sup> The mold has a 2.5-3 cm wide incised channel leading to one ear, into which the molten metal could be poured; the excavator theorizes that a metal pry bar could be inserted into this channel to remove the ingot from the mold once it had solidified.<sup>994</sup> In the position it was found in the palace, it is perhaps unlikely to have been filled by tapping molten copper from a furnace into the mold; perhaps an alternative casting method with crucibles could have been used.<sup>995</sup> The surface within the mold is uneven and shows spalling of the mold surface as well as deposits of slag and copper metal in and around the mold indicate that it had been

<sup>989</sup> Davey 1979, 103-4, 106; Muhly 1985b, 33.

<sup>990</sup> Dikaios 1971, 1:Pl. 127, 48-48a.

<sup>991</sup> Levy et al. 2002, 428-30; Levy et al. 1999, 1; Weisgerber 2003, 83

<sup>992</sup> Craddock et al. 1997, 4.

<sup>993</sup> Lagarce et al. 1983, 277, Fig. 15; Lagarce 1986, 88-9.

<sup>994</sup> Gale 1989, 257; Craddock et al. 1997, 4, 6; Lagarce 1986, 88-9.

<sup>995</sup> Lagarce 1986, Abb. 2; Lagarce et al. 1983, Fig. 12, 15.

used.<sup>996</sup> The exact function or functions of the courtyard in which the Ras Ibn Hani mold was found is unclear. It is located in the ‘North Palace,’ which closely resembles elite structures in nearby Ugarit.<sup>997</sup> Other production activities took place in the palace, including worked antler, corundum blocks, pearls, and possibly lead casting, as shown by finds of melted lead and two lead ingots.<sup>998</sup> The ingot mold was found in association with late 13th-century B.C. remains.<sup>999</sup> A ritual use of the ingot mold is possible, considering its location and comparable evidence of links between copper metallurgy and elite religious practices on several Cypriot sites (see Chapter VIII). Drains and ‘bathtubs’, in rooms adjoining the courtyard may have been used for ritual activity as well.<sup>1000</sup> As one of the main ports of Ugarit, Ras Ibn Hani had close economic and cultural relations with Cyprus in the Late Bronze Age, which probably accounts for its presence at the site. However, although the mold was clearly used at some point, how often it was used, and whether it was used for routine industrial production of oxhide ingots is unclear. It is possible that the ingot mold was transported from a production site to the palace, perhaps as a votive offering, or was utilized only on special ceremonial occasions.

Craddock *et. al.* cite the relative lack of ‘cold shots’, or droplets of spilled copper, on the Ras Ibn Hani mold as an indication that crucibles were not used to pour molten copper into the mold, although some crucible fragments were found and analyzed at the site.<sup>1001</sup> Some copper droplets found on the mold were recovered and analyzed by

---

<sup>996</sup> Craddock *et al.* 1997, 4; Lagarce 1986, 89.

<sup>997</sup> Lagarce 1986, 85.

<sup>998</sup> Lagarce 1986, 87, 90; Muhly 1985b, 36-7.

<sup>999</sup> Muhly 1985b, 36-7.

<sup>1000</sup> Lagarce 1986, 90.

<sup>1001</sup> Craddock *et al.* 1997, 6; Gale 1989, 255-6.



N. H. Gale, who found the lead isotope ratios in the copper to be consistent with a Cypriot source.<sup>1002</sup>

The mold siblings discovered among the Uluburun bun ingots could be used to estimate the number of times a mold like the Ras Ibn Hani mold could be re-used. The largest mold group found among the Uluburun bun ingots consists of twenty-one members or possible members, although most mold groups have far fewer members.<sup>1003</sup> This evidence indicates that a stone oxhide ingot mold would probably have a very limited life span before successive castings destroyed it completely. The Ras Ibn Hani mold may therefore have been used in some sort of infrequent ritual casting of ingots or was perhaps even left as a votive offering, rather than used in a truly industrial capacity. The quality of the stone used for the mold arguably discounts its use for industrial-scale production as well; it would be simpler and less labor-intensive to make a mold from stone or clay rather than carve a mold from a rectangular stone block of good-quality limestone, which would then have to be transported into the palace, and yet could be destroyed only after several casting operations. The lack of any identifiable remains of oxhide ingot molds from other Late Bronze Age sites also suggests that the Ras Ibn Hani mold is unusual, although this could change with further discoveries.

---

<sup>1002</sup> Gale 1989, 255-6.

<sup>1003</sup> C. Pulak and his 2000-2002 research team developed a system to evaluate the probability that a bun ingot is a member of a particular mold group. Each ingot in a mold group was given a rating of 1-3 'x's; one 'x' indicates a possible mold sibling while 3 'x's indicate a definite mold sibling, based on shared features of the ingots' mold surfaces. Pulak has also noted that some mold siblings have more pronounced irregularities in their mold surfaces than others, possibly due to increasing degradation of the mold after several castings, or possibly the use of a bun ingot as a simple mold template by pushing the ingot into sand.

Oxhide ingots were more likely made using open sand molds or clay-based molds, which would have been made with a clay and sand mixture and used only once. This would explain their rough mold surfaces and the apparent lack of mold siblings.<sup>1004</sup> The sides of the ingots are typically rough, characterized by a pair of parallel ridges or at least a row of gas porosities approximately halfway up the side of the ingot, and the typically rough mold surfaces of the ingots.<sup>1005</sup> The reason for these formations is unknown, although they could be due to two or more separate pourings of metal.<sup>1006</sup> Swells, or large, low bulges (larger than blisters) in the mold surfaces of oxhide ingots, are also common surface features. These features seem to indicate that the bottom surfaces of the molds were rather crudely finished. Similar features were observed on most of the Cape Gelidonya oxhide ingots.<sup>1007</sup> ‘Rims’ along the edges of the mold surfaces of Uluburun and Cape Gelidonya copper oxhide ingots could also have been easily formed in clay; Bass notes in the ingot casting experiment that the outline of the ingot made in a clay mold “remained deeper than the rest of the mold, and would have produced... a rim. Inadvertently the cause of the rim was discovered, and also the reason why it appears on most ingots but not all; the rim simply results accidentally when all of the clay in the mold is not removed to the level of the outline.”<sup>1008</sup> The fact that the oxhide ingot mold from Ras Ibn Hani is a unique example suggests that ancient metallurgists used more perishable materials to produce their molds.

<sup>1004</sup> Tylecote 1987a, 204, 208; Gale 1989, 255-7.

<sup>1005</sup> Pulak 2000a, 141-2, Fig. 6.

<sup>1006</sup> Hauptmann et al. 2002, 17-19. See also Pulak 1998, 196: “Systematic experimental casting of these ingots by INA Board Member John De Lapa suggests that such a groove is the result of the bottom half of the ingot being poured first and contracting slightly during cooling that took place before the second pour. Such grooves are not visible on bun ingots or the pillow-shaped ingots, which suggests that each was cast in a single pour.”

<sup>1007</sup> Bass 1967, 70.

<sup>1008</sup> Bass 1967, 70.

The exact mixtures for sand or clay molds, if they were in fact used to cast the ingots, are unknown and could have varied greatly. Bronze Age clay molds often included large amounts of sand and vegetable matter such as straw, dung, or plant ash.<sup>1009</sup> Each ingredient provides a useful property to the mold; sand “reduces contraction and improves refractibility,” while “straw, dung, or plant ash increase the porosity and permeability of the mold, thus allowing gases to escape and [particularly in the case of closed or two-piece molds] improving the ability of the molten metal to fill the mold.”<sup>1010</sup> Bivalve clay molds found on Middle and Late Bronze Age sites in Europe were often made with two grades of clay: a fine, levigated clay for the inner surface of the mold (to produce a smooth surface on the finished object) and a coarse ‘envelope’ clay for the outer part of the mold to provide structural strength.<sup>1011</sup> Some clay molds were baked or fired to temperatures of 350° Celsius or higher; this process reduces the gas content in the clay, giving it greater strength and thermal properties.<sup>1012</sup> Modern sand molds are made with ‘green sand’, about 95% damp sand and a 5% mixture of clay and water.<sup>1013</sup> 16th-century A.D. recipes for casting sand include mixtures of river sand and vinegar and burnt sand bonded with flour, ash, and moisture provided by urine or wine.<sup>1014</sup> Other recipes for mold materials are known from medieval times and later periods. Medieval bell founders used clay and sand mixed with horse dung used as a binder; the 16th-century master metalworker Biringuccio recommends combinations of clay and two-thirds wool cloth clippings for the production of clay molds, as well as mentioning other mixtures of clay with “coarse sand”, ashes, crushed brick, animal hair, finely cut straw or flax, animal dung, or clay moistened with salt

---

<sup>1009</sup> Wang and Ottoway 2003, 35; Tylecote 1986a, 84.

<sup>1010</sup> Wang and Ottoway 2003, 35.

<sup>1011</sup> Wang and Ottoway 2003, 35; Tylecote 1986a, 89; Soles et al. 2004, 22-3.

<sup>1012</sup> Wang and Ottoway 2003, 35-6.

<sup>1013</sup> Tylecote 1987a, 209, 232.

<sup>1014</sup> Smith and Gnudi 1966, 327-8.

water and mixed with rust or finely ground iron scale <sup>1015</sup> Agricola (A.D. 1554) describes simple copper ingot molds made of a mixture of rammed earth and charcoal; these were built adjacent to the smelting furnace, and molten copper was tapped directly into them.<sup>1016</sup> Simple, one-piece open molds of this type were probably the most commonly used molds for ingots in the Bronze Age; Unfortunately, remains of such molds are unlikely to be found archaeologically because of the materials used and the fact they would probably be used only once.<sup>1017</sup>

Bass believes that some physical features of oxhide ingots, such as a ridge along the edges of the mold surface, may be due to their casting in clay molds.<sup>1018</sup> Unfired clay molds would have been used only once, being broken up afterwards to remove the ingot once the metal had cooled.<sup>1019</sup> Clay molds in particular are less likely to survive archaeologically than stone molds since the clay of an unfired clay mold is never truly fired by the casting process.<sup>1020</sup> Molds have often been baked at temperatures up to 700° Celsius, however, to remove moisture; the duration and temperature of this baking will determine whether the mold is fully fired.<sup>1021</sup> Twenty-one fragments of clay molds for bun ingots have been discovered on 10th century B.C. smelting sites at Timna in the Sinai.<sup>1022</sup> These molds were thick, made with slag-tempered refractory clay, indicating that they were probably made locally near the smelting site, and had rounded rims, presumably to make removal of the ingot easier.<sup>1023</sup> Rothenberg notes

---

<sup>1015</sup> Tylecote 1987a, 238; Smith and Gnudi 1966, 219-20.

<sup>1016</sup> Hoover 1950, 377-8, 386.

<sup>1017</sup> Moorey 1994, 270-1.

<sup>1018</sup> Bass 1967, 70.

<sup>1019</sup> Tylecote 1987a, 209.

<sup>1020</sup> Tylecote 1987a, 218.

<sup>1021</sup> Evely 2000, 355.

<sup>1022</sup> Rothenberg 1990, 3, 54, 56-7; Catling 1964, 272-6.

<sup>1023</sup> Rothenberg 1990, 54.

that similar molds could have been used on many other sites, but may be difficult to recognize as molds due to their resemblance to furnace lining fragments.<sup>1024</sup>

Templates of wood or some other material may have been used to delineate the general shape of an ingot by impressing the template into loose sand. These have been used experimentally in replication experiments of oxhide ingots, and several of the two-handled ingots from the Uluburun ship seem to have similar shapes on one or two sides.<sup>1025</sup> Conceptually similar items may have been uncovered in a metallurgical workshop excavated at the Old Babylonian (early second millennium B.C.) site of Tell edh-Dhiba'i near Baghdad. Davey has identified a clay template for an axe head and a clay shaft-hole core for the casting of a socketed tool from the site, both of which he believes may have been used for sand casting.<sup>1026</sup> If such templates were made for finished tools, then it is also possible that templates could have been in use for copper ingots, which did not need to be shaped with as much precision.

No microscopic traces of the molds used to produce the Uluburun oxhide ingots (stone spalls, vitrified clay or quartz sintered to the ingot, etc.) have been discovered so far, and judging from previous casting experiments (for example, van Lokeren 2000; Merkel 1986a; 1986b, 265-7), they are unlikely to occur or be recognizable, particularly on ingots from an underwater archaeological context; such evidence could easily be removed from ingots during the mechanical cleaning of concretion from the

<sup>1024</sup> Rothenberg 1990, 3, 54.

<sup>1025</sup> Van Lokeren 2000, 275; see also Tylecote 1987a, 226, for their general use in casting. Of the two-handled oxhide ingots from the Uluburun shipwreck, KW 3193, KW 4486, and KW 1591 all have a similar shape on at least one longitudinal side. Nibbi (1987, 84-5) has proposed that oxhide ingots "are of this shape because copper was originally poured on to the furry side of an animal skin set level in the stony ground"; however, the 'legs' of oxhide ingots seem to be too small to have been based on the skinned legs of an animal, and the oxhide shape could be easily produced without using a dried animal skin as a template (cf. Bass 1967, 70-1).

<sup>1026</sup> Davey 1988, 65-6, 68; Moorey 1994, 267, 270-1.

artifacts' surfaces.<sup>1027</sup> Such traces may not have adhered to the ingots if the surfaces of the molds were coated in ash or some other substance to keep the metal from adhering to the mold once it had cooled.<sup>1028</sup> Such a treatment is likely in a mold for a finished copper or bronze object, but not necessary for an ingot destined to be broken up and remelted. No traces of the original mold material were found in a recent metallographic study of the Uluburun ingots.<sup>1029</sup>

If the Uluburun oxhide ingots were made from reusable stone molds, then they were generally cruder than those that were likely used to make the bun/plano-convex ingots. No mold siblings have been found among the oxhide ingots as of yet. Molds using one or more materials such as clay, earth, dung, plant material or sand seem to be a more likely possibility. As A. B. Knapp notes, clay and water would have been basic necessities at a smelting site; both would have been necessary for furnace construction, and could have been used to produce molds as well.<sup>1030</sup> Unfortunately, crude clay molds will not necessarily leave archaeological remains, particularly if they were made of unfired clay.<sup>1031</sup>

If clay molds were used, then they may have been built directly into the ground in close proximity to the melting furnace or furnaces. Tapping copper directly from a melting furnace into the ingot mold would probably be the most practical method of

<sup>1027</sup> Hauptmann et al. 2002, 18-9; Van Lokeren 2000, 275.

<sup>1028</sup> Biringuccio recommends a coating of rams' horn ashes on the interior of clay molds to keep the surfaces of the metal from adhering to the surfaces of the mold (Smith and Gnudi 1966, 253). Similar techniques may have been in use in the Bronze Age.

<sup>1029</sup> Hauptmann et al. 2002, 18-9.

<sup>1030</sup> Knapp 2003, 563.

<sup>1031</sup> These molds could have been considerably cruder than fired clay bivalve molds used to cast finished tools in the Late Bronze Age (Wang and Ottoway 2003, 35-8). Unfired clay or another plastic material or mixture would be quicker and less costly in terms of labor and fuel to make than a fired clay mold the size of an oxhide ingot, and would also have the advantage of being reusable.

casting,<sup>1032</sup> although conceivably large crucibles could have also been used (crucibles are more likely for smaller ingots). If the off-gassing of moisture in the clay (which occurs when wet clay comes into contact with molten metal) was kept to a manageable level, (perhaps by sun-drying or baking of the mold), this could have been a very practical method; off-gassing would have likely been less of a problem if other materials were added to the clay or if a sand mold was used. Normally clay molds would be heated before casting, in the case of finished objects to avoid creating a porous surface; however, creating smooth, non-porous surfaces on oxhide ingots was obviously not a concern of the ingot producers and may not have been possible due to residual impurities in the metal.<sup>1033</sup> If the molds were particularly crude, then it is likely that few or no traces would be found today. The survival of clay ingot mold fragments at Timna and the Feinan region of Jordan may have more to do with the remoteness and environmental conditions of the region (i.e., arid desert) and a relative lack of post-Bronze Age and modern development in the area than with the durability of the ingot molds used there.<sup>1034</sup>

Because of the perishable nature of many historically-documented mold materials, the identification of ingot production centers based on the remains of ingot molds is not likely to occur. Bronze-Age sites with likely involvement in oxhide ingot production are most likely to be identified by the large amounts of slag produced in the smelting of sulfide ores, or by slag produced in the refining of metal. By the end of the Late Bronze Age, smelting technology was sophisticated enough in some areas to achieve a

---

<sup>1032</sup> Ethnographic accounts of the production of Katanga crosses describe the tapping of molten copper from the furnace to a “mould hollowed out with the fingers directly in... clay or wet sand” (de Maret 1995, 136). This simple method is very similar to Bass’ hypothesis for oxhide ingot mold production (Bass 1967, 70).

<sup>1033</sup> Evely 2000, 355.

<sup>1034</sup> Rothenberg 1990, xviii, 3.

full separation between slag and copper in many smelts, although less efficient methods seem to have continued, sometimes on the same smelting sites.<sup>1035</sup> The earliest smelting evidence from Chalcolithic sites such as Timna Site 39 show that full separation between slag and copper was not achieved, due to an inability to heat the ore to a high enough temperature; instead, copper droplets called prills were formed within a solid or slightly viscous slag matrix.<sup>1036</sup> The ore was smelted long enough for prills to form in the slag, which was then allowed to cool. The furnace would then be dismantled and the slag block (known as ‘furnace slag’ by archaeologists) was pulverized in order to remove the copper prills; these could then be remelted into larger masses of copper.<sup>1037</sup> This method is somewhat inefficient; typically only about half of the copper in the ore is retrieved (for example, only 5-15% of the total material in copper ore smelted from Site 39 at Timna was retrieved as usable copper metal).<sup>1038</sup>

In later New Kingdom smelting operations at Timna, copper ore was routinely heated to sufficiently high levels to achieve full separation between slag and metal, as shown by the archaeological remains of large amounts of tapped slag; this was probably achieved by improved furnace construction and fluxing technology.<sup>1039</sup> Slag was tapped from the furnaces either continuously (resulting in ‘ropy slag’) or at intervals into ring-shaped pits, producing ‘ring-shaped’ slag cakes.<sup>1040</sup> The Timna evidence shows that the technological sophistication to produce tap slag and large ingots weighing several kilograms was known by the Egyptians by the Late Bronze Age, though earlier, more primitive methods (such as the crushing of furnace slag) as well

---

<sup>1035</sup> Tylecote 1971, 53; 1982, 87, 89; Muhly 1989, 305-8; Rothenberg 1990, 68.

<sup>1036</sup> Bachmann 1978, 22.

<sup>1037</sup> Rothenberg 1990, 5.

<sup>1038</sup> Rothenberg 1978, 9.

<sup>1039</sup> Rothenberg 1990, 66-8.

<sup>1040</sup> Merkel 1983, 174; Rothenberg 1990, 39, 44-5, 55, 63.



as mistakes in casting (such as allowing copper to run out into tap slag) are in evidence in the same period as well.<sup>1041</sup>

Slag from Apliki, a probable mining village in northern Cyprus dating to the 13th century B.C., was tapped, judging from the large blocks of slag recovered at the site.<sup>1042</sup> However, at the earlier site (c. 1700-1500 B.C.) of Politiko *Phorades* in the eastern Troodos foothills, plano-convex slag cakes, unique finds on Cyprus, were discovered.<sup>1043</sup> Their shape and microscopic structure indicates that the products of the smelt were left in the furnace; an ingot of copper matte formed on the furnace bottom below the slag due to the greater density of copper, and was later removed by the smelters, leaving the impression of the matte cake in the remaining slag (see Figure 17).<sup>1044</sup> The smelting process used at Politiko *Phorades*, therefore, appears to be an intermediate stage between the primitive smelting practiced in the Chalcolithic and earlier periods of the Bronze Age and the tapping methods in use by the Late Bronze Age.

By the Late Bronze Age, sophisticated smelting technology had been developed in several regions of the eastern Mediterranean and Near East. However, many details of the smelting, refining, and casting technology used in the manufacture of oxhide ingots may be difficult to reconstruct. Much of the equipment used in ingot production are unlikely to survive in the archaeological record, and the task of reconstruction becomes more difficult if different stages of the ingot production process occurred in different areas. Compositional analyses of slags and copper ingots provide valuable

---

<sup>1041</sup> Rothenberg 1990, 39, 42, 56-7, 63-8.

<sup>1042</sup> Du Plat Taylor 1952, 153; Muhly 1989, 307, 309.

<sup>1043</sup> Knapp 2003, 562.

<sup>1044</sup> Given and Knapp 2003, 216.

information on smelting technology, but also reveal that these end products could have been produced in a variety of ways.

The Uluburun copper cargo contains a variety of ingot types produced in several different ways, most within a relatively small mining region of Cyprus in the 14th century B.C. The significance of this fact is unclear. Plano-convex ingots, being smaller, would be less difficult to produce and perhaps easier for smiths to melt.<sup>1045</sup> Perhaps oxhide ingots were produced in smaller metallurgical installations in more isolated or rural areas on a seasonal basis, while bun ingots were produced at one or a few workshops where production was more standardized, incorporating the use of reusable stone molds into the production process, as shown by the groups of mold siblings. The incised marks on the bun ingots seem to indicate a less heterogeneous source or means of collection; fewer types of incised symbols are found on the bun ingots than on the oxhide ingots, and more of the bun ingots seem to have the same marks as on the oxhide ingots.<sup>1046</sup> However, oxhide ingots are more numerous archaeologically, and represent both a larger total weight of metal than bun ingots. Additionally, due to their size oxhide ingots seem to require a more complex casting operation than bun ingots; it is therefore difficult to say whether one type or the other is more characteristic of an 'assembly-line' type of production process.

Oxhide ingots seemed to have been favored for a particular reason (perhaps foreign demand or regulation by a central authority) as a form for raw copper, especially since smelted copper would have to be remelted to make them (oxhide ingots could not be

---

<sup>1045</sup> Tylecote 1987b, 223.

<sup>1046</sup> See Chapter III.

made directly from a smelting furnace).<sup>1047</sup> However, large amounts of metal in other forms were deemed acceptable; the differences in ingot types found on the Uluburun ship could reflect local customs in different localities, or perhaps simply expedience or the personal preferences of individual smelters. However, the fact that chemically analyzed oxhide ingots show a remarkable uniformity in composition and metallographic structure suggests some degree of uniformity in smelting and refining techniques and some sort of quality control, probably from a centralized authority. In Hauptmann et al.'s conclusion of their study of the composition of the Uluburun ingots, they state that "several batches of raw copper would have been collected at the 'primary' smelter, close to the ore deposits. These may have been transported to urban settlements to be remelted into larger units."<sup>1048</sup> Derckson has proposed a remarkably similar reconstruction of the structure of the Anatolian copper trade around Kanish in the early second millennium B.C.:

Most copper was obtained in or near the towns of Turhumit and Tišmurna, which were located closest to the major mining areas... A large part of the copper appears to have been unrefined or poorly so. As the demand for poor copper was small, it was often exchanged for refined copper in Turhumit and Tišmurna. These towns were metallurgical centers, where a considerable amount of copper was refined, probably controlled by the local palace.<sup>1049</sup>

A similar situation may be reflected in the archaeological remains from Late Bronze Age Cyprus, which will be examined in the next chapter.

---

<sup>1047</sup> Hauptmann et al. 2002, 12.

<sup>1048</sup> Hauptmann et al. 2002, 18.

<sup>1049</sup> Derckson 1996, 180-1.

## CHAPTER VIII

### ARCHAEOLOGICAL EVIDENCE FOR COPPER PRODUCTION IN LATE BRONZE AGE CYPRUS

The most significant copper deposits in the eastern Mediterranean are found on Cyprus. Evidence of Bronze Age smelting activity at major ore sources on Cyprus is extremely rare, however. Such evidence, if it existed, may have been destroyed by later mining activity in many cases, particularly by modern mining and development.<sup>1050</sup> Cyprus also has significant surface erosion problems, due largely to human activity; such erosion can easily destroy intact archaeological deposits.<sup>1051</sup> Despite large gaps in the archaeological record, some evidence for Cypriot Bronze Age mining and smelting has been uncovered. Ancient mine shafts, adits, and galleries are known from many sites in copper-rich areas of the Troodos massif; few copper deposits exploited in modern times were missed by the ancient miners.<sup>1052</sup> Often these tunnels contained ancient pottery, tools, and wooden supports.<sup>1053</sup> At Mavrovouni, wooden supports for an ancient mining tunnel were discovered during mining operations in the 1930s; timbers from ancient mine passages uncovered at the modern mine at Mitsero *Kokkinoyia* have radiocarbon dates clustering in the ninth to seventh century B.C., the sixth to third centuries B.C., and the third to fifth centuries A.D.

<sup>1050</sup> Given and Knapp 2003, 85, 177.

<sup>1051</sup> Wells 2001, 132, 135-6.

<sup>1052</sup> Bruce 1937, 639-71; Merrillees 1984, 1-11; Constantinou 1992; Given and Knapp 2003, 45.

<sup>1053</sup> Bruce 1937, 649-70; Merrillees 1984, 1-13; Given and Knapp 2003, 175-7.

(Figure 25).<sup>1054</sup> Similar radiocarbon dates have been obtained from mining timbers and charcoal in ancient slag heaps in the mining areas.

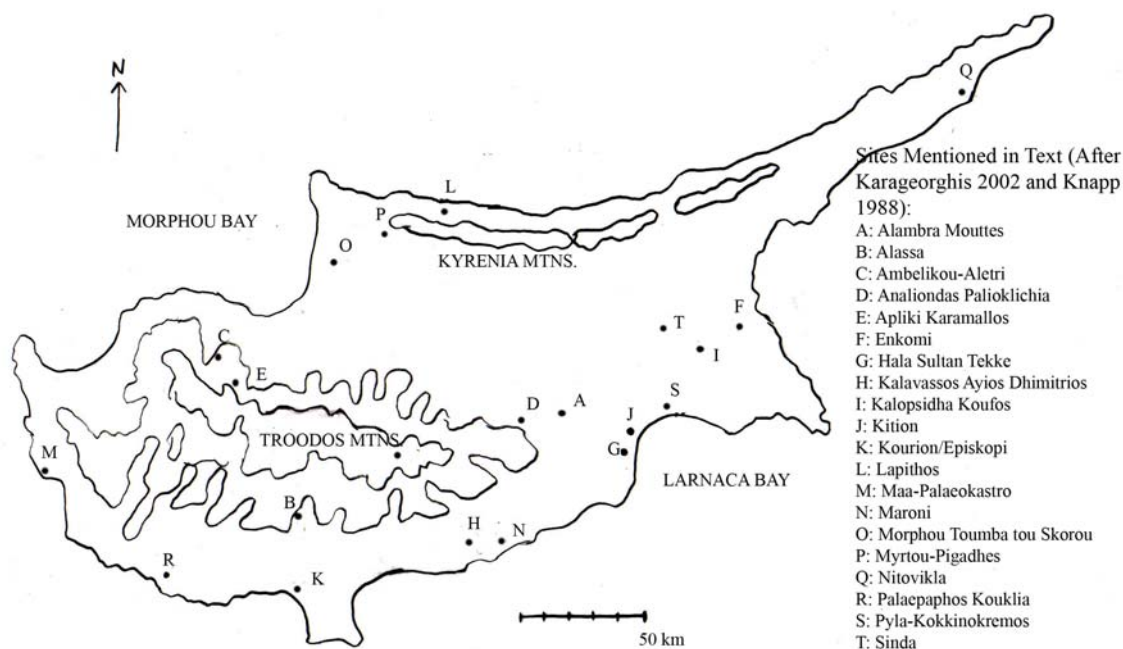

**Figure 29: Map of Cyprus showing major Bronze Age sites mentioned in the text (Adapted from Karageorghis 2002, 6, and Knapp 1988, 148).**

Ancient slag heaps are another major feature of the Cypriot archaeological landscape. Massive slag heaps are found at Kalavassos and other regions, although none have been dated to the Bronze Age.<sup>1055</sup> Most slag heaps which have been systematically investigated are Roman in date, although significant Archaic and Classical period slag heaps are known as well, particularly in the area of Tamassos in the northern Troodos.<sup>1056</sup> Spoil heaps of waste material from beneficiation and roasting were also

<sup>1054</sup> Bruce 1937, 649-60; Constantinou 1992, 59-63; Given and Knapp 2003, 177.

<sup>1055</sup> Weisgerber 1982, 26; Tylecote 1977, 318-20.

<sup>1056</sup> Given and Knapp 2003, 46, 61-2, 73, 178-9.

been identified; well-stratified examples date from the Cypro-Geometric I to the Roman period.<sup>1057</sup>

While little has survived of the Chalcolithic and Bronze Age copper industry in comparison to the remains from later periods, evidence for a large indigenous bronze industry has been well known for years, from metal finds in numerous tombs dating back to the Early and Middle Cypriot periods (c. 2400-1700 B.C.) as well as evidence of metallurgical activity and finished bronze objects from settlements, particularly several Late Cypriot urban centers.<sup>1058</sup> Most finished bronze objects discovered on Cyprus have lead-isotope signatures consistent with the local Cypriot ore sources, indicating that the industry was an indigenous one, only selectively adopting foreign object types and fuelled using local ore deposits, although the original metalworking technology was likely imported from Anatolia or the Near East.<sup>1059</sup>

Evidence for Bronze Age metallurgical processes comes from several types of archaeological sites (Figure 29). These include isolated finds of metal hoards, mining operations, and settlements dating from the third and second millennium B.C. whose archaeological remains include evidence of metallurgical activities.

<sup>1057</sup> Given and Knapp 2003, 45, 65-9, 70-3, 82-5, 96-103, 136-8, 142, 166-9.

<sup>1058</sup> Knapp 1993, 98-100; Catling 1964, 55-77; Keswani and Knapp 2003; Steel 2004, 141-2; Keswani 2005.

<sup>1059</sup> Gale 2001, 116; Philip 1991, 69-70, 86-7, 98-9; Stos-Gale and Gale 1994, 111-6; Gale et al. 1996, 397; Steel 2004, 117, 124-8.

*Evidence of Large-Scale Metallurgical Activity Pre-dating the Late Bronze Age/Late Cypriot Period*

Evidence of a high degree of organization in mining and production occurs in the Mediterranean region (as well as in more distant areas such as Yugoslavia, Bulgaria, and central Anatolia<sup>1060</sup>) at a very early date. Although the earliest metallurgical evidence on Cyprus comes from the Late Chalcolithic site of *Kissonerga-Mosphilia*, this evidence is consistent with small-scale copper production rather than larger-scale copper production for export.<sup>1061</sup> Similar material occurs at several Middle Cypriot sites such as *Alambra Mouttes*, where crucible and mold fragments and pieces of copper slag from the smelting of oxidized ores were found.<sup>1062</sup> However, several sites well within the core geographic area where oxhide ingots are distributed in the Late Bronze Age show a surprising degree of sophistication in all levels of copper production, from mining to ore beneficiation, smelting, refining, and casting of finished objects.

The site of *Pyrgos-Mavrorachi* near Limassol on the southern coast of Cyprus is perhaps the earliest known example of a large-scale ore processing and smelting site known on the island. Remains from *Pyrgos-Mavrorachi* associated with metallurgy date from the Late Chalcolithic to the Early and Middle Cypriot period.<sup>1063</sup> The settlement may have been up to 30 hectares in the Early to Middle Cypriot period. Excavations at the site have revealed extensive industrial installations including artificial channels thought to be part of a “hydraulic washing system” for the

---

<sup>1060</sup> Yener 2000; Jovanović 1980; 1988.

<sup>1061</sup> Steel 2004, 120, 138-9. The metallurgical remains from the site consist of copper ore, metal objects, smelted copper, and possible crucible fragments (Giardino 2000a, 19).

<sup>1062</sup> Frankel and Webb 1996, 213; Tylecote 1986b.

<sup>1063</sup> Belgiorno 2000, 3.

beneficiation of copper ore, large numbers of stone tools such as hammer stones and grinding querns, slag, various benches, walls, and shelters associated with the canals, and the probable remains of two roasting and/or smelting furnaces and possible tapping pits; this evidence shows that all stages of the production of copper, from ore beneficiation to the smelting of sulfide ores and the casting of objects, occurred at the site.<sup>1064</sup> Belgiorno, one of the site's excavators, states that the site "was really organized like a proto-industrial complex, qualified to transform copper into metal and the metal into objects."<sup>1065</sup> The copper ore processed at the site may have come from sources near the modern village of Pyrgos, which were exploited in antiquity; copper carbonate outcrops also occur about 300 m from the site.<sup>1066</sup>

The smelting methods used on the site was the "slagging method", similar to that used by Chalcolithic smelters at Site 39 at Timna; ore was smelted until a slag cake containing copper prills was produced; then, the slag cake was allowed to cool, the furnace was dismantled, and the slag crushed to retrieve the copper prills.<sup>1067</sup> Both copper prills and crushed slag fragments were found on the site.<sup>1068</sup> The water channels may have been useful in separating the copper from the slag as well, since the copper is denser; this explanation could also explain why so little slag was found in Early and Middle Cypriot levels at the site.<sup>1069</sup> "Small, sandy pieces of oxidized copper" were also recovered from the Bronze Age layers at the site, possibly waste

<sup>1064</sup> Belgiorno 2000, 3-10; Giardino 2000a, 19.

<sup>1065</sup> Belgiorno 2000, 10.

<sup>1066</sup> Belgiorno 2000, 12; Giardino 2000a, 19.

<sup>1067</sup> Belgiorno 2000, 13; Tylecote 1977; Rothenberg 1978; 1990, 4-7; Giardino 2000a, 25.

<sup>1068</sup> Giardino 2000a, 21; Belgiorno 1999, 74-5.

<sup>1069</sup> Belgiorno 2000, 13-4. The lack of slag could also be due to the smelting of carbonate or oxidized ores. A variety of troughs and sorting devices using water, primarily for gold and tin ore, are detailed by Agricola (1556) (Hoover 1950, 290-348).



material from the slag crushing process.<sup>1070</sup> The earliest slag deposits on the site date to the Middle Cypriot levels; nonetheless, this is the oldest securely dated slag on the island and some of the oldest known in the eastern Mediterranean.<sup>1071</sup>

Analysis of the slag indicates that it formed at temperatures between 1100-1200 degrees Celsius (supporting the theory that it was not tapped, since it would have flowed freely at this temperature); the presence of cuprite and the large amount of iron in the slag indicate that it was formed in an oxidizing atmosphere for at least part of the smelting process, possibly due to a process in which roasting and smelting was performed in the same furnace.<sup>1072</sup> Large amounts of copper in the slag recovered indicate that primary smelting was taking place on the site or nearby.<sup>1073</sup> The presence of some fayalite in the slag indicates that some kind of forced draught was used in the furnaces, since only a forced draught can produce temperatures high enough to form fayalite (around 1200° Celsius).<sup>1074</sup> It is unclear whether blowpipes or bellows were used to produce a forced draught in these furnaces, although judging from the shape of the furnaces the latter is more likely. Only one tuyere has been found on the site, however; it was in situ in the bottom of a bowl-shaped depression, probably the remains of a furnace.<sup>1075</sup> Burnt remains of three ‘blowpipes,’ probably tuyeres made of organic material (wood or reeds?) were identified near one furnace.<sup>1076</sup> It is possible that blowpipes were used on the site, though they are poorly suited to such large-scale metallurgical operations.<sup>1077</sup>

---

<sup>1070</sup> Giardino 2000a, 25.

<sup>1071</sup> Giardino 2000a, 21.

<sup>1072</sup> Giardino 2000a, 23, 25.

<sup>1073</sup> Giardino 2000a, 23.

<sup>1074</sup> Giardino 2000a, 25; Tylecote 1987a, 107.

<sup>1075</sup> Belgiorno 2000, 8.

<sup>1076</sup> Belgiorno 1999, 76.

<sup>1077</sup> Belgiorno 2000, 8; Tylecote 1981; Giardino 2000a, 25.

The shape and construction of the furnaces used on the site is difficult to determine, since the furnaces seem to have been demolished after each use; however, a series of charred bowl-shaped depressions were certainly used for pyrotechnological operations.<sup>1078</sup> The furnaces were circular and apparently constructed from stones and mud bricks.<sup>1079</sup> Some seemed to have been lined with lime plaster, in one case in a layer up to 13 cm thick.<sup>1080</sup> Lime plaster is not a refractory material and is unsuitable for the lining of a smelting furnace, but it could have been used as a lining for roasting pits or furnaces; some depressions lined with lime plaster had a clay lining added when the pits were reused as the bottom of smelting furnaces.<sup>1081</sup>

There may have been several types of furnaces on the site. Some furnace remains seem to consist of single pits, 18-33 cm in diameter, while others consisted of double pits with a hole or trough connecting the two (perhaps to accommodate a pot bellows and tuyere?); a single example of three pits of decreasing sizes, situated in a row was also found.<sup>1082</sup>

A stone lid with a hole in its middle was found in association with one pit; a stone stopper which could have fit in the hole was found nearby.<sup>1083</sup> These facilities may have been used for casting finished objects, with the lid serving to cover a crucible or one-piece mold to avoid heat loss (if used with a crucible) or porosity in the cast

---

<sup>1078</sup> Belgiorno 2000, 8-10.

<sup>1079</sup> Belgiorno 2000, 8.

<sup>1080</sup> Belgiorno 2000, 10.

<sup>1081</sup> Belgirono 2000, 8, 10; Giardino 2000a, 25.

<sup>1082</sup> Belgiorno 2000, 10.

<sup>1083</sup> Belgiorno 2000, 10.

caused by the escape of gases which had been absorbed by the molten metal (particularly hydrogen) as it cools (if used with a mold).<sup>1084</sup>

A “coppersmith’s tomb” was discovered in the nearby village of Pyrgos; it dates to the same period as the site and contained a small hoard (about 1 kg) of copper tools, weapons, and jewelry along with large limestone whetstones similar to examples found at Pyrgos *Mavrovachi*; the wealth of the tomb is seen by the excavators as evidence for the high status of metallurgists during this period.<sup>1085</sup> Other tomb assemblages from the area also suggest an unusual degree of wealth. Studies of the composition of metal objects found in MC tombs in the area reveal a fairly high percentage of tin bronzes; of twenty-six copper and copper alloy artifacts studied, thirteen had a tin content of above 2%, while most of the rest were arsenic bronzes (possibly accidental, from the smelting of local ores containing arsenic); only four objects were made of pure copper.<sup>1086</sup> Tin or tin-alloy ingots or artifacts begin to appear on other Middle Cypriot sites in the early second millennium B.C.; for example, three tin bronzes were identified from the contemporary inland site of *Alambra Mouttes*.<sup>1087</sup> The higher number of MC tin bronzes around Pyrgos may be due to its position on the coast and its apparent importance as a copper-exporting site; since tin would necessarily be imported to Cyprus, the settlement would have easier access to foreign metal sources than the inland site of *Alambra*. Tin originating in central Asia or some other region may have reached Pyrgos to be exchanged for locally smelted copper or copper alloy objects; the site is roughly contemporary with

---

<sup>1084</sup> Giardino 2000a, 27; Tylecote 1962, 133; Evely 2000, 328, 346-7.

<sup>1085</sup> Giardino 2000a, 27.

<sup>1086</sup> Giardino et al. 2000, 37, 39, 41, 44-5.

<sup>1087</sup> Gale et al. 1996, 397.

the first references to “copper from Alashiya” in texts from Near Eastern and Anatolian sites (see Chapter II).<sup>1088</sup>

This evidence shows that metallurgical activity was an important, if not the primary, production activity occurring on the site. The excavators believe that Pyrgos *Mavrovachi* may have been a regional supplier of finished copper objects and perhaps ingots as well.<sup>1089</sup> The industrial installations found at Pyrgos would have required the labor of a significant part of the community to operate. The ‘coppersmith’s tomb’ suggests a high status for smiths in local society during the EC-MC periods, a status which may have continued, with some changes, into the Late Bronze Age. A pair of hippopotamus teeth in the same layers as metallurgical debris indicates probable trade contacts from outside of Cyprus.<sup>1090</sup>

A second early site, *Ambelikou-Aletri*, is located in the northern foothills of the Troodos Massif near the village of Ambelikou; it was originally discovered in the 1940s during mining operations in the area.<sup>1091</sup> Evidence of Middle Cypriot metallurgical activities come from two sites in the area. Bronze Age pottery dating to the MC I period was found in ancient mineshafts in the area; other possible Bronze Age remains included stone hammers and possible grindstones which could have been used in ore beneficiation.<sup>1092</sup> These remains are the oldest evidence found on Cyprus for copper shaft mining. The function of the pottery found in the mines is unknown, although Merrillees suggests that the vessels may have served to store drinking water

---

<sup>1088</sup> Muhly 1996, 49.

<sup>1089</sup> Belgiorno 2000, 14.

<sup>1090</sup> Belgiorno 1999, 78.

<sup>1091</sup> Merrillees 1984, 1-3.

<sup>1092</sup> Merrillees 1984, 3, 6.

as the miners transferred ore out of the mines for processing outside.<sup>1093</sup> Although the site was never extensively excavated, a Bronze Age settlement existed near the mineshafts as well.<sup>1094</sup> In addition to pottery finds within the mines, a shallow crucible found at the habitation site as well as slag, a 35 cm-long, straight ‘D-shaped’ tuyere, probably used for a melting or refining furnace, a two-piece clay mold for axes, and a piece of copper ore indicate that some sort of small-scale metallurgical activity occurred, probably the smelting and/or casting of objects.<sup>1095</sup> U. Zwicker’s analysis of slag from the crucible indicates that it had probably been used for remelting copper prills from a smelting process, possibly using a manganese-oxide flux to lower the melting temperature of the slag (a piece of manganese-oxide ore as well as two pieces of copper ore mixed with roasting products were also found on the site).<sup>1096</sup>

Significantly, evidence for major exploitation of Cypriot copper ores before the early second millennium B.C. has not been discovered. The earliest evidence on Cyprus of metallurgical activity at a significant scale is also consistent with funerary evidence of large-scale copper production on the island in the form of copper and arsenic bronze

<sup>1093</sup> Merrillees (1984, 7) believes copper stains on the vessels are due to exposure of pottery to copper minerals in the ground rather than the use of the vessels to collect a copper sulphate solution, as described by Galen (Constantinou 1982, 19, 22. See also Chapter IV).

<sup>1094</sup> Merrillees 1984, 4.

<sup>1095</sup> Merrillees 1984, 6-7, 11; see also Tylecote (1971, 53, 55-6; 1982a, 96) for a reconstruction of the crucible smelting method which was probably used at Ambelikou. Crucible slags can be distinguished from smelting slags by high amounts of non-ferrous metals and ash, low iron, high amounts of silica and alumina from the reaction of the slag with the crucible clay, and tend to be highly vesicular, almost resembling pumice (Gale et al. 1996, 385-9). Like the Ambelikou-*Aletri* slag, slag from the MC site of *Alambra-Mouttes* seems to be from small-scale crucible smelting rather than refining (Gale et al. 1996, 390).

<sup>1096</sup> Zwicker 1982, 63-4. Manganese may have been used as a flux on the Middle Cypriot site of *Alambra Mouttes* as well. At a rock outcrop called Skamnia, 1.5 km from the site “an unusually large number of manganese nodules” can be found: “It may be significant that this is the only place in the region where Bronze Age pottery can be found in clear separation from the settlement and surrounding tomb clusters; highly fragmented and weathered Red Polished pottery occurs at Skamnia in association with chipped stones and the manganese nodules” (Gale et al. 1996, 367). Manganese oxide was also used as a flux during the Roman period; it was quarried from umbers in strata between the copper deposits (Given and Knapp 2003, 91-2, 102).

grave goods, chiefly at the Early-Middle Cypriot cemeteries of Bellapais *Vounous* and Lapithos-*Vrysi tou Barba* in northern Cyprus.<sup>1097</sup> Lead isotope analyses of copper and copper alloy objects from these sites indicate that they were produced from local ores.<sup>1098</sup>

Archaeological evidence on Cyprus indicates that the intensification of copper production on the island probably began as an indigenous development and only gradually came to accommodate a foreign demand for copper.<sup>1099</sup> Keswani has concluded from her analysis of metal artifacts in funerary contexts of the period that the increase in metal production on Cyprus was an indigenous development based on social competition between kin-groups; the importance of displaying and interring valuable copper goods “created an important internal stimulus for the intensification of copper production and the development of local copper exchange networks.”<sup>1100</sup> Keswani sees no evidence of any tight control or restriction of access to copper by elites in this period (“The same types of metal goods occurred in both richer and poorer tombs; the main difference is that the richer tombs tended to have a broader representation of types and multiple examples of particular types”), and ascribes this to status competition between family or clan groups in the form of public consumption of metals in public funerary displays rather than evidence of control of metal consumption by elites.<sup>1101</sup> By the beginning of the Late Cypriot period, (c. 1600 B.C.), this began to change. Foreign goods, particularly from the Levant, became more popular, including tin-bronze shaft-hole axes and other weapons, cylinder seals,

<sup>1097</sup> Keswani 2005, 342, 351, 362-70; Catling 1964, 76-7.

<sup>1098</sup> Gale et al. 1996, 397; Stos-Gale and Gale 1994, 116-21.

<sup>1099</sup> Knapp 1993, 90-101; Manning 1993, 35-6.

<sup>1100</sup> Keswani 2005, 341, 360-70, 393-4.

<sup>1101</sup> Keswani 2005, 370; Frankel 1993, 61.

horses, bronze-encrusted ‘warrior belts’ and other objects begin to appear only in the wealthiest tombs.<sup>1102</sup> Keswani interprets this as a result of native Cypriots finding new ways to enhance their prestige through the use of foreign imports as new “prestige symbols”:

When the panache of current prestige symbols becomes diluted by their general availability... social aspirants must either retreat from display altogether or find new and innovative ways of asserting their status... [G]oods of non-local origin may have been highly valued because of their scarcity, exotic allure, and association with foreign elites (whose material culture and ideology may have been perceived as more prestigious). In identifying with the values and ideology of foreign elites, emergent Cypriot leaders may have begun to posit new status distinctions between themselves and other members of their communities and to create an ideological basis for institutionalized social inequality.<sup>1103</sup>

Control of copper production and export would have been vital to acquiring foreign luxury goods, as well as tin for bronze.<sup>1104</sup> A combination of foreign demand for Cypriot copper and attempts by indigenous groups or individuals to enhance their prestige and political power likely played an integral role in the intensification of copper production on Cyprus. Evidence for copper production in other areas of the eastern Mediterranean may provide some clues for why foreign demand intensified during this period.

*Aegean and Near Eastern Copper Sources of the Early and Middle Bronze Age*

The recent excavation of an Early Minoan smelting site on the coast of northeastern Crete provides important evidence for the evolution of Cretan metallurgy in the period contemporary with the early stages of the development of Cypriot metallurgy. The

<sup>1102</sup> Keswani 2005, 392-3; Manning 1993, 49.

<sup>1103</sup> Keswani 2005, 392; Knapp 1993, 90-101; Manning 1993, 46-9.

<sup>1104</sup> Keswani 2005, 394.

Chrysokamino metallurgical site is located on a cliff near the town of Kavousi on the coast of eastern Crete, about half a kilometer from a Minoan ‘villa’ or habitation site.<sup>1105</sup> No local copper sources are known in the area; therefore, the copper ore located on the site must have been imported, either by land or, more likely, by sea.<sup>1106</sup> Over 700 kg of slag were excavated from the site, indicating that a small but substantial smelting operation existed on the site.<sup>1107</sup> The condition of the ore fragments found on the site seems to support the hypothesis that they were imported from elsewhere; all of the ore and slag pieces found are small pieces, all under 3 cm in diameter.<sup>1108</sup> While such evidence could have eroded into the sea at this site, the excavators suggest that the primary ore beneficiation may have occurred elsewhere.<sup>1109</sup> The almost complete absence of stone hammers (only twenty-two stone tools were found, and eight are possibly misidentified as tools) and the lack of obvious anvil or grinding stones on the site is more difficult to explain in light of the presence of large amounts of copper slag, which was also broken up to retrieve copper prills trapped in the slag matrix.<sup>1110</sup> Metallurgical activity clearly occurred on the site, judging from large amounts of ore and slag on the site and by finds of metallurgical equipment. The latter include fragments of a “minimum of ten” pot bellows (dating to the EM III level of the site) and fragments of tapering clay cylinders, open on one end, possibly the remains of furnaces; these are perforated with “many holes” and some

---

<sup>1105</sup> Betancourt et al. 1999, 343, 349-51.

<sup>1106</sup> Betancourt et al. 1999, 352, 362.

<sup>1107</sup> Hakulin 2004, 3.

<sup>1108</sup> Betancourt et al. 1999, 353-4.

<sup>1109</sup> Betancourt et al. 1999, 364; Craddock 1995, 37-46, 156-61.

<sup>1110</sup> Betancourt et al. 1999, 362, 364-6. A pair of shallow depressions were found in the bedrock near the site; while these would be suitable for pounding and grinding ore or slag, many more of these features would be expected to be on the site if the primary stages of ore beneficiation took place on the site (Betancourt et al. 1999, 366). For an example of such ore-grinding stones, see Hauptmann 2005.



have slag deposits containing copper prills in their bottoms.<sup>1111</sup> Remains of sea urchins and shells were also found at the site; the excavators hypothesize that these were brought to the site as a source of calcium carbonate flux.<sup>1112</sup> No evidence of casting or melting has been found on the site.<sup>1113</sup> The site may have been chosen for the constant breeze, which may have helped smelt the metal, particularly if natural-draught furnaces were used, although pot bellows were in use at some point in the site's history and bellows made from organic materials could have also been used.<sup>1114</sup>

A small apsidal building was built on the site in its second period of occupation (EM III); this structure has been interpreted by the excavators as a temporary housing and activity area for the smelters.<sup>1115</sup> Significantly, structures of this shape are not local to Crete in this period, but are common in Anatolia and northern Greece.<sup>1116</sup> It was built on approximately 45 cm of slag accumulation from earlier smelting activity, indicating that a significant amount of production had occurred before the EM III period.<sup>1117</sup>

---

<sup>1111</sup> Betancourt et al. 1999, 354, 358-9, 362. Stos-Gale collected some pieces of "coarse pottery... with identical small round holes" from the site; (1998, 721, Fig. 11-2); she theorizes that these were from "bee-hive shaped covers for the smelting charge", covering bowl-shaped furnaces dug into the ground "since there are no obvious fragments of crucibles or furnace bottoms among the slag." She also identifies slag from the site as "primitive copper slag," and obtained two thermoluminescence dates from the Oxford laboratory for the pottery 'furnace cover' fragments of 4410 +/- 345 BP (2420 +/- 345 B.C.) and 4700 +/- 365 BP (2710 +/- 365 B.C.) (Stos-Gale 1998, 721). The holes in the sides suggest that these were natural draft furnaces.

<sup>1112</sup> Betancourt et al. 1999, 354. The use of limestone or other lime-rich material as fluxes in Chalcolithic smelting at Timna has been proposed, but Rothenberg (1978, 8) ascribes the presence of large amounts of CaO in slags from different periods at Timna to be due to calcite in both the copper ore and charcoal used to smelt the ore. Carbonate ores are self-fluxing (Maddin 1988, 172).

<sup>1113</sup> Betancourt et al. 1999, 363.

<sup>1114</sup> Betancourt et al. 1999, 363.

<sup>1115</sup> Betancourt et al. 1999, 360.

<sup>1116</sup> Betancourt et al. 1999, 363.

<sup>1117</sup> Betancourt et al. 1999, 360-3; Muhly 2004, 287.

The volume of smelting performed on the site is difficult to judge; however, it seems to have been a fairly small smelting operation.<sup>1118</sup> The slag deposits could have been accumulated over a long period of time during which smelting occurred at the site only infrequently. Much of the original slag and other debris produced in the ore processing and smelting may have been eroded or deliberately discarded over the cliff.<sup>1119</sup> The site has been dated to c. 2700 B.C. by the thermoluminescence analysis of pottery from the site; this pottery has also been dated stylistically from the Final Neolithic to EM III periods, with most of the pottery dating from the latter period.<sup>1120</sup>

Chrysokamino may have supplied the local region with copper in ingot form, which could be further refined in crucibles and cast into objects.<sup>1121</sup> The metallurgical evidence from the site is thought by its excavators to be evidence of early maritime trade in copper, perhaps from the Cyclades; trade connections had been established between sites in east Crete such as Ayia Photia in this period, and archaeological evidence and lead-isotope studies have shown several islands in the Cyclades were exploited as early sources of copper, lead, and silver, particularly Kythnos, where an Early Bronze Age II smelting site has been identified.<sup>1122</sup> The site of Skouries is the largest EBA metallurgical site in the eastern Mediterranean; during this time, an arsenical copper deposit was exploited, leaving a scatter of crushed furnace slag.<sup>1123</sup> A possible contemporary settlement was identified nearby, with pottery dating to the Early Cycladic I-II periods (c. 3100-2400 B.C.), while radiocarbon dates obtained from charcoal in slag and pottery at the site date the remains to the early third

---

<sup>1118</sup> Betancourt et al. 1999, 353.

<sup>1119</sup> Betancourt et al. 1999, 353, 364.

<sup>1120</sup> Betancourt et al. 1999, 347, 354.

<sup>1121</sup> Betancourt et al. 1999, 363.

<sup>1122</sup> Betancourt et al. 1999, 363; Stos-Gale and MacDonald 1991, 265-7; Stos-Gale 1993, 120-5.

<sup>1123</sup> Muhly 2004, 287; Stos-Gale et al. 1986; Stos-Gale 1989, 279-80, 284.

millennium B.C., or the Early Cycladic period.<sup>1124</sup> Other slag deposits in the Cyclades, such as a slag heap at Kephala on Seriphos, have not been dated but could conceivably have been produced in the Early Bronze Age.<sup>1125</sup> Like the Chrysokamino site, the Kythnos site is situated on a high cliff, perhaps to provide a natural draft for smelting furnaces.<sup>1126</sup> There is no evidence for production at the site after the third millennium B.C.<sup>1127</sup>

Unlike many similar Cypriot sites with metallurgical remains, Chrysokamino seems to have been involved in a truly maritime trade in copper, in which copper ore nodules were exported from copper mines to smelting sites in Crete and other parts of the Aegean in order to produce matte or pure copper. Stos-Gale (1998; 2001) notes that copper slag heaps located in the Cycladic islands are also not in the immediate vicinity of copper ore deposits, suggesting that the importation of beneficiated or roasted ore to Chrysokamino was not unique.<sup>1128</sup> Since only one insignificant copper ore deposit has been identified on Crete, it is more likely that the copper ore was transported from the Cyclades. Minoan and Cycladic metallurgy of this period are stylistically very similar, and lead-isotope readings from Early Bronze Age slags from the Cyclades are consistent with a source at Kythnos but not closer local ore deposits.<sup>1129</sup> The most likely explanation for this may involve the technology of copper smelting in this period; if in fact the smelters were dependent on natural draft furnaces, then copper ore would likely have to be transported to a sufficiently windy area to smelt the

<sup>1124</sup> Stos-Gale 1989, 279-80; 1998, 719.

<sup>1125</sup> Stos-Gale 1998, 720.

<sup>1126</sup> Stos-Gale 1998, 719.

<sup>1127</sup> Stos-Gale 1989, 288.

<sup>1128</sup> Stos-Gale 2000, 61: "The copper and lead/silver occurrences on the Cyclades are rather small and widely distributed, thus promoting the collecting of ore and its shipping to one coastal location as an economical option." See also Stos-Gale 1998, 721.

<sup>1129</sup> Stos-Gale 1998, 720-1.

ore.<sup>1130</sup> However, this cannot entirely explain the choice of Chrysokamino as a smelting site due to the distance involved in travel to the Cyclades and the fact that since pot bellows were obviously available for smelting for at least part of the site's history. Perhaps early smelters opportunistically collected copper ore from certain well-known mines or ore deposits not directly controlled by any particular group, or the inhabitants of Kythnos exercised a local monopoly on copper mining or export.<sup>1131</sup> The occasional collection of copper ore by Bronze Age metallurgists for smelting from unguarded or loosely controlled ore deposits in the Cyclades is plausible for the early stages of metallurgical activity in the Aegean. However, the scale and complexity of Minoan metalworking activity by the Middle and Late Minoan periods argue for a more organized and intensive exploitation of copper and other metal ores at their sources and a more organized importation of metals into Crete.<sup>1132</sup>

Lead-isotope data provides a more detailed picture of Early- and Middle Bronze-Age metallurgical production in the Aegean than does the scarce archaeological remains of production from this period. The most common sources of copper for the Aegean, including Crete, seem to have been Kythnos and other deposits in the Cyclades or northern Greece, followed by Laurion in Attica, which was also exploited for lead and silver in the same period.<sup>1133</sup> Additional deposits were being exploited in the Troad

---

<sup>1130</sup> Finds from metallurgy sites in the Levant seem to indicate that natural draft furnaces were typical of the Chalcolithic and Early Bronze Age. Early Bronze Age smelting sites in the Arabah region of the Sinai were consistently found on hilltops, suggesting to Rothenberg and Glass (1992, 143) that these windy locations were chosen to provide a strong draft for the smelting furnaces. Early Bronze Age smelting furnaces at Feinan were built on similar hilltops; remains of these furnaces include small clay 'sticks' or rods, sometimes found parallel to each other embedded in slag; these are thought to have been used to construct a grate to aid in the side of the furnace to provide draft (Weisgerber 2003, 82-3; Hauptmann 2003, 90, 93). A lack of tuyeres on these sites also points to natural draft furnaces (Hauptmann 2003, 93-5).

<sup>1131</sup> Stos-Gale 1998, 724.

<sup>1132</sup> Wiener 1990, 146; Gale 1998, 739.

<sup>1133</sup> Kayafa et al. 2000, 43, 46, 49; Stos-Gale and Gale 1990, 86; Gale 1998, 751; Stos-Gale 1998, 724.

and Chalkidiki region of the northern Aegean, other parts of north Anatolia, and even regions further afield; some lead isotope results are from unknown copper sources, possibly in the Caucasus or central Asia but, unfortunately, no lead-isotope data is yet available from ore deposits in these regions.<sup>1134</sup> Preliminary work has also been conducted on defining the lead-isotope field of Balkan copper ore deposits and identifying the sources of Bronze Age metal objects discovered in the region. Preliminary results show that the lead isotope readings from Balkan deposits are significantly different from those of metal objects found in Greece, Cyprus, or Anatolia; apparently Balkan metals were exported only to other areas of southeastern Europe.<sup>1135</sup>

Early and Middle Bronze Age metallurgical production consisted of the exploitation of small local metal deposits, probably on a limited small scale or region-wide basis. Kythnos and Laurion were major foci of activity, although a lack of archaeological and lead-isotope evidence of later exploitation suggests that the Kythnos deposits may have been played out or abandoned by the Late Bronze Age. Laurion continued to supply copper to Knossos in later periods with copper, and silver was also produced there; small amounts of copper from the Uluburun ship also seem to have been obtained from Attica.<sup>1136</sup> Lead-isotope analyses of early examples of oxhide ingots show that the Minoans continued to receive copper from other unidentified deposits as well, some of which may have arrived in the form of early oxhide ingots.<sup>1137</sup> The

<sup>1134</sup> Kayafa et al. 2000, 49, 52-3.

<sup>1135</sup> Gale et al. 2003, 168-70; Stos-Gale et al. 1997, 105.

<sup>1136</sup> Stos-Gale and Gale 1990, 80, 88; Cummer and Schofield 1984; Gale 1998, 752. Wiener (1990, 133) suggests the second millennium B.C. site of Ayia Irini on Kea was also processing copper ores from Laurion at a large scale, but metallurgical remains from the site (such as large amounts of litharge) seem to point to silver production instead (Gale 1998, 752).

<sup>1137</sup> Stos-Gale and Gale 1990, 78-9.

exploitation of more remote sources of copper suggests that the procurement of the metal was still done in a somewhat haphazard way; supplies were obtained by a combination of exploitation of small local or regional sources and a collection of small amounts of metals from further afield. No single source in the eastern Mediterranean seemed to be able to supply the Minoan demand on its own. Cyprus' contribution to Minoan metallurgy probably started on a small scale as one of several sources of imported copper. The first copper from Cyprus appearing in the Aegean is found on the Minoan site of Akrotiri on Thera, destroyed in the mid-17th century B.C.<sup>1138</sup> By the late 14th century B.C., when the Uluburun ship sank, Cyprus was the dominant supplier.

The absence of Near Eastern copper in the Aegean, for example from Jordan and the Sinai, is striking, particularly in earlier periods. These regions actually had much longer histories of copper production, but seem to have formed exchange networks largely separate from Aegean trade networks until the Late Bronze Age. Several sites illustrate the distinct nature and scale of copper production in this region.

Khirbet Hamra Ifdan is located in the Feinan region of southern Jordan, an area exploited for copper since at least the Chalcolithic period.<sup>1139</sup> The scale of the copper smelting and refining operations at this site are unprecedented for the period. While earlier theories on copper production in the Levant focused on small metallurgical operations and itinerant metalworkers, Khirbat Hamra Ifdan provides evidence of an "assembly-line" operation primarily during the EB III-IV period (c. 2700-2000 B.C.)

---

<sup>1138</sup> Stos-Gale and Gale 1990, 84.

<sup>1139</sup> Hauptmann et al. 1989, 6-10; Rothenberg 1972; 1990; Dever and Tadmor 1976.

in which large numbers of ingots and finished objects were cast in clay molds and exported to the surrounding region.<sup>1140</sup>

The earliest evidence for metal production in the Feinan region dates to the Chalcolithic Period (c. 4500-3600 B.C.).<sup>1141</sup> By the EB II-III period (c. 2900-2200 B.C.), large-scale mining activities involving the excavation of galleries and shafts were occurring; thirteen sites with over 5,000 tons of slag are known from this period, probably representing the production of several hundred tons of copper, the largest amount of regional copper production known for this period in the Near East.<sup>1142</sup>

Metallurgical evidence at Khirbet Hamra Ifdan was discovered in a complex of more than 80 rooms and courtyards.<sup>1143</sup> The copper used at the site was probably smelted near the mines, although small quantities of ore, primarily malachite, chrysocolla, and copper chlorides, and slag that were excavated indicate that some smelting also occurred on the site.<sup>1144</sup> According to the excavators, the copper was probably brought to the site in the form of prills (many of which were found on the site) produced in primary smelting operations elsewhere (probably small smelting camps such as an Early Bronze Age smelting camp recently identified at 'En Yahav in Israel), and then purified and agglomerated in a series of remeltings in crucibles.<sup>1145</sup> Some metal objects were also recycled, but no copper alloy objects have been discovered on the site.<sup>1146</sup> Melting and casting occurred in the southern, largest courtyard of the site, where hundreds of clay mold fragments for the casting of axes, chisels, pins, blades,

---

<sup>1140</sup> Levy et al. 2002, 425, 428-30.

<sup>1141</sup> Levy et al. 2002, 427; Hauptmann 1988; 2003; Weisgerber 2003.

<sup>1142</sup> Levy et al. 2002, 427-8.

<sup>1143</sup> Levy et al. 2002, 430.

<sup>1144</sup> Levy et al. 2002, 430, 432.

<sup>1145</sup> Levy et al. 2002, 430, 432; Yekutieli et al. 2005.

<sup>1146</sup> Levy et al. 2002, 430, 433.

and distinctive bar or crescent-shaped ingots were found; in other areas, finished objects were cold-worked and polished.<sup>1147</sup> The main period of production occurred in the EB III period (c. 2700- 2200 B.C.), though production continued at a smaller scale in to the EB IV (c. 2200-2000 B.C.).<sup>1148</sup> The site is anomalous for this region in that it shows clear evidence of highly organized craft production and yet a lack of monumental architecture or other urban characteristics typical of the fortified towns of this period in the Levant.<sup>1149</sup> Its location “on the edge of the desert, rather than the Mediterranean ‘centre’ of EBA urban settlement,” is also unusual; these factors suggest that the settlement was organized and controlled by a central authority elsewhere in the region.<sup>1150</sup>

The main periods of metallurgical activity at Khirbet Hamra Ifdan pre-date most of the metallurgical remains found on Cyprus in this period, showing that large-scale, centrally organized metal production evolved in the eastern Mediterranean long before Cyprus became a major exporter of copper.<sup>1151</sup> Bar-shaped ingots from Feinan or neighboring copper deposits have not been found on Cyprus or the Aegean, and lead isotope analyses have not identified metals from the Aegean or Cyprus as originating in the Feinan deposits or in other nearby sources such as Timna. The locations of these ore sources, the local environments, and the evolution of metallurgical technology in the Levant may account for this absence.

<sup>1147</sup> Levy et al. 2002, 431-2.

<sup>1148</sup> Levy et al. 2002, 428-9.

<sup>1149</sup> Levy et al. 2002, 433, 436.

<sup>1150</sup> Levy et al. 2002, 433-4.

<sup>1151</sup> There is little contact between Cyprus and the Levant in the Early Bronze Age, although similarities in the design of hook-tang weapons from Cyprus and north Palestine suggest that some transmissions of metallurgical technology was occurring by the EB IV period (c. 2350-2000 BC) (Philip 1991, 70-1).



Some of the oldest evidence for copper metallurgy in the Near East comes from the Feinan and Arabah regions; however, these developments seem to have been of only regional importance.<sup>1152</sup> In the Arabah, a long tradition of copper production by the local inhabitants began in the mid-fourth millennium B.C.; however, there is very little evidence for large-scale production of copper, and copper does not seem to have been produced for export over longer distances until the EB IV period, when crescent-shaped ingots like those made in the Feinan were manufactured in the Arabah and traded into southern Palestine.<sup>1153</sup> Smelting sites of this period in the Arabah have remains of slag weighing up to “hundreds of kilograms,” while earlier sites have much less; before the EB IV, this was certainly a “cottage industry,” and even in this period there seems to have been no extensive contact with Egypt.<sup>1154</sup> Indigenous exploitation of copper also occurred in the Feinan, where much larger copper deposits exist and much more significant copper exploitation occurred in antiquity; copper smelting was practiced at the Chalcolithic village of Wadi Fidan 4, where “smelting was done on a domestic scale, leaving only tiny amounts of slags,” as well as crucible fragments; significant amounts of mining of copper took place in the area during this period and increased in the subsequent Early Bronze Age.<sup>1155</sup> In this period, Hauptmann et al. estimate that 100 tons of metal were produced, based on dated slag deposits.<sup>1156</sup> However, by the Middle Bronze Age, smelting activity appears to have ceased both at Timna and in the Feinan, not to be revived in the former region at a significant scale

<sup>1152</sup> Rothenberg et al. 1978; 1990; Maddin and Wheeler 1976; Dever and Tadmor 1976; Rothenberg 1988, 3-15; Hauptmann 1988; 2003; Levy and Shalev 1989; Hauptmann et al. 1992; Rothenberg and Glass 1992; Adams and Genz 1995; Levy et al. 2001; Weisgerber 2003.

<sup>1153</sup> Rothenberg and Glass 1992, 151; Yekutieli et al. 2005, 16-7. Lead-isotope analysis of bar-shaped ingots from ‘Ein Ziq and Be’er Resisim in the central Negev region indicate that they were probably from local ores (Segal et al. 1999, 183). Plano-convex ingots may have also been produced in this region in the same period (Yekutieli et al. 2005, 10).

<sup>1154</sup> Rothenberg and Glass 1992, 144, 151.

<sup>1155</sup> Hauptmann et al. 1992, 3, 6-7; Adams and Genz 1995, 11-2, 14, 17, 19; Weisgerber 2003, 79-81.

<sup>1156</sup> Hauptmann et al. 1992, 7.

until c. 1300 B.C., and then under Egyptian direction, while in the Feinan major copper smelting operations do not recommence until the first millennium B.C.<sup>1157</sup> ‘Desertification’ of the regions by the consumption of local fuel and food sources may account for this phenomenon; perhaps mining in these arid regions could not be supported without either local food and water supplies or the means to import such supplies safely on a regular basis.<sup>1158</sup> In some cases, the copper ore may have been brought from the desert to areas with more abundant water, fuel, and forage for livestock. This may explain the small EB II-IV period copper smelting site at ‘En Yahav in the central Arabah; copper ores were carried to this well-watered site from sources up to 30 km away.<sup>1159</sup> Finally, the location of these copper sources on the fringes of several major civilizations of the period— the Egyptian, Hittite, and Mesopotamian states—may have diverted any copper production during peacetime towards these regions rather than towards Mediterranean civilizations further west, and in times of hostility could have made mining and smelting in these regions dangerous. All three regions had other means of obtaining metals, whether through local production or the importation of metals from a variety of sources; perhaps for some Near Eastern states copper was more easily imported than exploited closer to home.<sup>1160</sup>

Large numbers of workers seem to have been mobilized for metallurgical operations at Pyrgos *Mavrovachi* and Khirbet Hamra Ifdan, while the site of Chrysokamino offers the first compelling evidence for the export of copper ore (rather than ingots or finished objects) by sea in the eastern Mediterranean, a practice which has been called

<sup>1157</sup> Hauptmann et al. 1992, 7; Rothenberg 1988, 276; Segal et al. 1999, 179.

<sup>1158</sup> Hauptmann et al. 1992, 7.

<sup>1159</sup> Yekutieli et al. 2005, 17, 19.

by some scholars impractical due to the amount of gangue or waste material which would also be transported.<sup>1161</sup> These sites show a surprising degree of sophistication in metallurgical production during the Early and Middle Bronze Age. It seems likely that, based on these sites, well-organized, centralized metal production was far more common in the eastern Mediterranean than previously thought, although it occurred at a smaller scale than what occurred in the Late Bronze Age. There is little direct evidence of a *large-scale* interregional or long-distance trade in metals in the eastern Mediterranean during this period. Copper production at sites such as Pyrgos and Khirbet Hamra Ifdan doubtless had regional importance, but were probably not capable of producing the amounts of metal proposed for the Late Bronze Age copper trade.

#### *Late Cypriot Sites and the Copper Trade*

Evidence for copper production and trade during the Late Bronze Age is extensive but often problematic. Most evidence for industrial activity during the Late Bronze Age seems to come from settlements, often in elite contexts such as workshops attached to temples or sanctuaries, although smelting sites from the Late Bronze Age have now been identified and excavated as well. Other categories of evidence include scrap metal hoards, which often contain oxhide ingots, and tombs, where finished metal objects were deposited.

---

<sup>1160</sup> Moorey 1994, 246-7.

<sup>1161</sup> Betancourt et al. 1999, 352-3, 362; Stech 1985; Wiener 1990, 148.

Oxhide ingots have been most frequently found on land in scrap metal hoards. Metal hoards can be deposited for a variety of reasons; as foundation deposits to important buildings, as votive offerings, or as a method of hiding valuable material during times of trouble. This latter explanation has been used to explain virtually all oxhide ingots found in metal hoards on Cyprus and most of the oxhide ingot finds from land contexts elsewhere, although miniature oxhide ingots were almost certainly ritual or votive objects of some kind.<sup>1162</sup> The fact that most evidence of oxhide ingots from land sites consists of ingot fragments rather than complete ingots supports the idea that they are from founders' hoards rather than dedications to gods.

Unfortunately, the archaeological contexts of these hoard finds, both on Cyprus and elsewhere, are often uninformative when they have not been completely destroyed; many hoards are therefore difficult to date accurately.<sup>1163</sup> The dating of scrap hoards from Cyprus, when not associated with intact archaeological deposits, has been done almost entirely on stylistic grounds of objects associated with the ingots, since no reliable stylistic chronology for oxhide ingots has been established. Hoards typically contain worn-out or broken objects intended to be broken up for scrap, which may further confuse attempts to date hoards precisely. Catling dates all bronze hoards

---

<sup>1162</sup> Knapp 1988, 156, 171; Knapp et al. 1988, 249-50, 254. Miniature oxhide ingots have been found in Egypt, Cyprus (five at Enkomi alone), Croatia, and the Levant (see Appendix 1). Webb (1999, 241) notes that "None... have been found in certain association with ritual assemblages" and "the contextual associations of these small ingots do not indicate a predominantly ritual or votive function." It is difficult to conceive of any other function for them, however, particularly the inscribed examples from Enkomi and the examples from the foundation deposits of an Egyptian temple at Thebes (O'Connor 1967, 172-4).

<sup>1163</sup> Catling 1964, 278-9, 281-5; Muhly et al. 1988, 234, 237; Knapp 1988.

found on Cyprus to after 1200 B.C., based on stylistic grounds.<sup>1164</sup> It seems that a large number of these hoards were deposited c. 1250-1150 B.C., during the period of unrest in which the Bronze Age ended in the eastern Mediterranean.<sup>1165</sup> The bronze tools and other objects from the Cape Gelidonya shipwreck also seem to be contemporary with these hoards, having close parallels with Cypriot and Near Eastern tools of this period.<sup>1166</sup>

Why hoards of scrap bronze all seem to date to this period on Cyprus is unclear. Metal was hoarded for a variety of reasons long before 1200 B.C., as archaeological finds such as the Tôd Treasure (c. 1936 B.C.) from Egypt, an 18th century hoard from Larsa containing bronze ingots, or the famous Chalcolithic hoard at Nahal Mishmar in Palestine show.<sup>1167</sup> The widespread destruction associated with the 1200 B.C. period in the eastern Mediterranean has been frequently cited to explain the abundance of surviving hoards from this period.<sup>1168</sup> Cyprus appears to have been enjoying a relatively stable period before 1200 B.C.; however, by the late 13th and early 12th century B.C. fortification walls are built around pre-existing settlements, including major towns such as Enkomi and Kition, while new settlements were founded at sites

<sup>1164</sup> Catling 1964, 278, 281; Karageorghis 1973.

<sup>1165</sup> Karageorghis and Demas 1984, 63; Muhly 1980b, 159; Knapp et al. 1988, 233. This may be coincidental, however, since this was a period in which a large number of settlements were destroyed. The burying of scrap metal hoards was probably a frequent occurrence throughout the Bronze Age, but their owners or others doubtless recovered many of these hoards later.

<sup>1166</sup> Bass 1967, 118-21.

<sup>1167</sup> Bisson de la Roque 1950; Bar-Adon 1980; Karageorghis and Demas 1984, 64. The Tôd Treasure contains folded bowls of precious metal, which seem to have been valued for their material rather than craftsmanship; in this respect, they can perhaps be identified as 'scrap metal.' Moorey (1988, 182) suggests that the Nahal Mishmar hoard could be called a 'treasury hoard,' representing the stored metal wealth of a community hidden in a time of stress; however, he points out that none of the objects from the hoard were broken objects or scrap metal clearly intended for remelting.

in Cyprus such as *Pyla-Kokkinokremos*, *Maa-Palaeokastro*, and *Sinda* to the west of *Enkomi*.<sup>1169</sup> The condition and find contexts of some scrap hoards and bronze objects has suggested to some that their rapid burial is a response to an external threat. For example, a hoard from this period discovered at *Sinda*, probably dating to a c. 1200 B.C. of the settlement, contains mainly what appear to be bronze ritual paraphernalia, such as an elaborate bronze wall bracket, a bronze portable hearth or table, a *situla*, a pair of tongs, and a ‘charcoal shovel’, all in good condition; “Of the eleven objects in the *Sinda* hoard... only three were clearly destined to be melted down.”<sup>1170</sup> The discovery of the ‘Horned God’ at *Enkomi* buried in a small pit in the ‘Temple of the Horned God’ suggested to *Dikaios* that it too was temple wealth deliberately hidden from some imminent threat, perhaps ritually buried.<sup>1171</sup> This may be true, although the burying of metal hoards was probably a common practice; perhaps under normal circumstances these were recovered by their owners. Nonetheless, the dating of Cypriot and many known Aegean hoards to a rather confined period (c. 1250-1150 B.C.) is suggestive.<sup>1172</sup> Theories that the increasing number of hoards and other evidence of metal recycling was a response to a metal shortage are unlikely, however. The range of metal objects and the frequency of their discovery seem to argue against this interpretation; the increasing amounts of metal scrap may indicate that demand for

---

<sup>1168</sup> Knapp 1988; Knapp et al. 1988; Drews 1993.

<sup>1169</sup> Karageorghis and Demas 1984, 28-31, 72-3.

<sup>1170</sup> Karageorghis 1973, 73-8, 81.

<sup>1171</sup> *Dikaios* 1969:1, 219; 1969:3a, Pl. 43.

<sup>1172</sup> Knapp et al. 1988, 250.

metals had increased but was being met in a fairly systematic way by metallurgists on Cyprus and elsewhere.<sup>1173</sup>

The situation on Cyprus seems to be particularly complex. Unlike the Mycenaean palaces and Levantine centers such as Ugarit, which are destroyed around c. 1200 B.C., (presumably by the 'Sea Peoples,') and never reoccupied on a significant scale, several major Cypriot settlements are also destroyed in this period but seem to recover fairly quickly and prosper for a century or more before finally being abandoned in the 11th century B.C.<sup>1174</sup> The Late Cypriot social order may have changed gradually in response to the c. 1200 B.C. upheavals, according to V. Karageorghis, through a process of gradual assimilation of Aegean (?) refugees, possibly in several waves, who, in turn, gradually began to dominate Cypriot society politically.<sup>1175</sup> This process likely took several centuries and began with trade contacts in the Late Cypriot period.<sup>1176</sup> Late Mycenaean-style weapons (which were, in turn, influenced by European types), such as Naue Type II broadswords and bronze leg greaves discovered at Enkomi, appear on the island by c. 1200 B.C.<sup>1177</sup> After another wave of destruction in the 11th century B.C., only Kition remains of the major Bronze Age centers on the island.<sup>1178</sup> Mycenaean-style pottery, first seen in large quantities on the island in the 14th and 13th centuries B.C., becomes more common, and imitations are

<sup>1173</sup> Knapp 1990, 56; Karageorghis and Kassianidou 1999, 172. Artzy 2000, 27-9.

<sup>1174</sup> South 1989, 322-3; Karageorghis and Demas 1985; Iacovou 1994, 150.

<sup>1175</sup> Karageorghis 1994, 4-6; Iacovou 1994, 158-60. The identity and influence of the 'Sea Peoples' has been extensively discussed and debated. For some of the major sources on their influence, see Gitin et al. 1998 (eds.); Sandars 1985; Karageorghis 1994; Stager 1995; Sherratt 1998.

<sup>1176</sup> Artzy 1994, 133-4.

produced locally.<sup>1179</sup> Ashlar masonry is often cited as another foreign introduction from this period, although it had been known on the island for centuries; nonetheless, there was an unprecedented use of ashlar monumental architecture beginning in the 13th century B.C. in large elite structures at Kalavassos *Ayios-Dhimitrios*, Enkomi, Kition, Maroni *Vournes*, Myrtou *Pigadhes*, and Alassa.<sup>1180</sup> These buildings were used as sanctuaries (particularly a monumental altar at Myrtou *Pigadhes* and temples at Enkomi and Kition) production and/or storage centers for olive oil at Kalavassos *Ayios Dhimitrios*, Maroni *Vournes*, and Alassa *Palioteverna*.<sup>1181</sup> By c. 1000 B.C., however, the original Bronze Age settlement pattern seems to be abandoned completely in favor of an entirely new one; the inhabitants of the coastal areas build cities and cemeteries in a different style more closely related to Mycenaean practices rather than the traditional practices of Bronze Age Cypriots.<sup>1182</sup> The evidence from the Late Bronze and Early Iron Ages on Cyprus suggest that refugees from the Aegean and perhaps elsewhere, gradually settled on the island, had mostly peaceful relations with the native inhabitants, and gradually supplanted many aspects of traditional Cypriot culture either by force, peaceful cultural assimilation (such as intermarriage), or a

---

<sup>1177</sup> Sandars 1985, 91-5; Schaeffer 1952, Pl. LXVIII; Bouzek 1985, 209-11; Karageorghis 1994, 3; 2002, 96-7.

<sup>1178</sup> Karageorghis and Demas 1985, 280.

<sup>1179</sup> Karageorghis 1994, 2-3.

<sup>1180</sup> Hult 1983; Karageorghis and Demas 1985, 272, 276-7; Cadogan 1996, 16-21; Hadjisavvas 1996, 28-34. Hult (1983, 88-90) points out that ashlar masonry arrived on Cyprus long before the LC II. The earliest example is the MC III/LC I fortress of Nitovikla on the Karpass Peninsula in northeastern Cyprus. This building style was probably inspired by Syrian examples, although ashlar masonry and ashlar facades were adopted in many areas of the eastern Mediterranean. Cypriot culture had been influenced by Near Eastern architecture and material culture for centuries; rather than seeing the extensive use of ashlar masonry on LC II sites as a result of a large influx of foreign colonizers or immigrants as some have proposed, she ascribes it to the increase of wealth on the island in this period.

<sup>1181</sup> Karageorghis 2002, 57, 63, 65-7, 105; Hadjisavvas 1996, 25, 28-34; Negbi 2005, 14.

<sup>1182</sup> Karageorghis 1994, 6; Iacovou 1994, 150-8.



combination of both, by about 1000 B.C.<sup>1183</sup> By this time the first Greek inscriptions are known from the Palaepaphos-*Skales* (Cypro-Geometric I), perhaps indicating the ethnicity of the colonizers.<sup>1184</sup> Unfortunately, this change is a complex one and the role of the ‘colonizers’ or ‘refugees’ is still hotly debated; the changes cited as evidence of Aegean colonization could perhaps be due to other factors.<sup>1185</sup>

Oxhide ingots have been discovered in two settlements proposed to be those of ‘refugees’ from the c. 1200 B.C. period. The site of Pyla-*Kokkinokremos*, located on a highly defensible plateau on the northern coast of Larnaca Bay, 10 km east of Larnaca, was occupied for only twenty-five or thirty years and was abandoned around 1200 B.C.<sup>1186</sup> Its identification as a refugee settlement by its excavators is based on several factors. The site was obviously chosen for defense, being located on a high plateau and surrounded by a wall; but the size of the settlement and the domestic as opposed to obviously military nature of its architecture suggest a settlement rather than a military outpost.<sup>1187</sup> More importantly, its proximity to Enkomi is considered unusual by Karageorghis and Demas (1984); it is large, well planned, and obviously intended to be a permanent settlement, which, according to the excavators, would be unnecessary for a military outpost maintained by the nearby indigenous settlements (although the indigenous people would likely have need of an agricultural and trading settlement halfway between Enkomi and the copper mines).<sup>1188</sup> They conclude the site is a “fortified refugee settlements” made by one or more foreign groups. According to

<sup>1183</sup> Karageorghis 1994, 4-6; Iacovou 1994, 158-9.

<sup>1184</sup> Karageorghis 2002, 127.

<sup>1185</sup> Steel 2004, 192-9; Sandars 1985; Karageorghis 1994, 2-4; Sherratt 1994; 1998.

<sup>1186</sup> Karageorghis and Demas 1984, 1, 3, 63.

<sup>1187</sup> Karageorghis and Demas 1984, 24, 29, 32.

<sup>1188</sup> Karageorghis and Demas 1984, 29-30.

Karageorghis and Demas, this explanation also applies to two contemporary settlements: *Maa-Palaeokastro*, a small fortified site on a promontory on the east coast of the island, and Sinda, a fortified site to the west of Enkomi.<sup>1189</sup> The fact that *Maa-Palaeokastro* was heavily fortified on both landward and seaward sides and the presence of ashlar masonry has been cited as evidence that the site does not seem to be the type of settlement the indigenous people would build.<sup>1190</sup> Steel points out, however, that the artifact assemblages occurring on these sites are similar to those on any other Cypriot site; she suggests the more likely explanation that these are defensive settlements constructed by the indigenous people to defend important trade or communication routes.<sup>1191</sup> Whether or not these are ‘refugee’ settlements is unclear but the emphasis on fortified settlements shows a decrease in stability during this period, which corresponds with the deposition of most Cypriot hoards.

The Founder’s Hoard at *Pyla-Kokkinokremos* contains five oxhide ingot fragments, including two ‘handles’, but no evidence of copper metallurgy at the site is found aside from a pit with greenish fill and fragments of copper slag. A silver and a gold scrap hoard were also found; this evidence suggested to the excavators that some kind of metallurgical workshop existed on the site.<sup>1192</sup> Similarly, at *Maa-Palaeokastro*, three oxhide ingot fragments were found along with scrap bronze, copper slag, and a ceramic pot bellows.<sup>1193</sup> However, no evidence of large-scale metallurgical activity

<sup>1189</sup> Karageorghis and Demas 1984, 29-32.

<sup>1190</sup> Karageorghis and Demas 1988, 261-2.

<sup>1191</sup> Steel 2004, 190-2.

<sup>1192</sup> Karageorghis and Demas 1984, 12. Lead isotope analysis of two of these fragments are consistent with an origin from Cypriot ores, while a third is not and may have originated in Anatolia. The chemical compositions of the fragments are very similar to other known oxhide ingots; they are made of very pure copper, with low levels of arsenic and sulfur (Gale and Stos-Gale 1984, 99-100).

<sup>1193</sup> Karageorghis and Demas 1988, 22, 218, 221, 254, 428-9, Pl. CLII, n. 256; Muhly and Maddin 1988, 471-2.

was found at Pyla *Kokkinokremos* or at Maa-*Palaeokastro*, and what was found did not seem to be closely involved with a ‘sacred precinct’, any ritual activity, or production associated with a temple or elite institution; most likely metallurgy at the site was conducted to satisfy local needs rather than for export.<sup>1194</sup>

This contrasts with some Late Cypriot metallurgical finds, particularly from Enkomi, Kition, and possibly Atheniou.<sup>1195</sup> Much of the metallurgical evidence known from Cypriot settlement sites of this period is associated with either cult areas or elite areas of some other kind.<sup>1196</sup> Metallurgical activity in the temple precincts may have had little to do with specific beliefs and may have only been a means for elites to produce wealth, and need not necessarily have involved a sort of fertility cult of copper as proposed by some scholars.<sup>1197</sup> However, a connection between metallurgy and religion is known from various Near Eastern sites; certain deities’ connections to metallurgy are well-known in the LBA in the Near East and are frequently found in ethnographic accounts as well.<sup>1198</sup> This connection may not have been recognized by the supposed newcomers to Cyprus who settled briefly at Maa-*Palaeokastro*, Pyla-*Kokkinokremos*, and (later) at other sites. This evidence suggests that by 1200 B.C. the Cypriot copper industry was a highly organized, centrally controlled affair run by elites in large, primarily coastal settlements, but that copper was also circulating at other levels of society as well.<sup>1199</sup> Cyprus seems to have developed an elite group

<sup>1194</sup> Karageorghis and Demas 1988, 262, 266.

<sup>1195</sup> Vermeule and Wolsky 1990, 128; Dothan and Ben-Tor 1983; Cadogan 1996, 15.

<sup>1196</sup> Karageorghis and Demas 1985, 253; Knapp 1986, 13.

<sup>1197</sup> Lagarce and Lagarce 1996, 2; Catling 1971, 29-30; Knapp 1986, 9, 23-4.

<sup>1198</sup> Artzy 1995, 22-5; 2000; Karageorghis and Demas 1985, 240-62; Knapp 1986; Dalley 1986; Rothenberg 1988, 54-5, 277; Lambert 1991. More limited evidence of metallurgy is known at a few Late Cypriot sites; for example, slag was found at Kalopsidha *Koufos*, a slag and a scrap hoard that included fragmentary rod tripods were found at Myrtou-*Pigadhes*, and slag possibly dating to the Late Cypriot period was uncovered in the sanctuary at Idalion (Åström 1966, 115; Catling 1957; Knapp 1986, 52-5).

<sup>1199</sup> Keswani and Knapp 2003, 213; Negbi 1986, 97.

similar to those found in these societies by the Late Bronze Age, although perhaps not a true palace economy with a large bureaucracy like that operating in Mycenaean palaces and which produced the Linear B tablets. A less centralized structure may have sufficed for this level of organization; according to Muhly “no true palaces” exist on Cyprus until the fifth century B.C. palace at Vouni, as opposed to workshops, temples, or public buildings, of which several examples are known.<sup>1200</sup> There are undeniable signs of some sort of strong centralized authorities in many Late Cypriot settlements, perhaps some sort of oligarchical structure, if not irrefutable evidence of royal families or single rulers.

*Metallurgy in Cypriot Coastal Settlements:*

1) Enkomi

Enkomi has provided the best-known and widest variety of evidence for oxhide ingots, Late Cypriot metallurgical practices, and the connection between metallurgy and religion in Late Cypriot society. Enkomi is a large site, estimated at approximately fifteen hectares, on the northeastern coast of Cyprus.<sup>1201</sup> Established at the end of the Middle Bronze Age, the site became one of the largest if not the largest Late Cypriot settlements on the island; it was occupied from c. 1700 B.C. until its abandonment in the 11th century B.C. in favor of the newly established settlement at Salamis.<sup>1202</sup>

Enkomi has been identified by Schaeffer and others as the capital city of Late Cypriot ‘Alashia.’<sup>1203</sup> While this identification is by no means certain, its size and wealth are obvious, particularly from its architecture, including a large fortification wall, streets

<sup>1200</sup> Muhly 1985b, 37.

<sup>1201</sup> Hirschfield 2002, 56.

<sup>1202</sup> Karageorghis 2002, 100; Dikaios 1971:3, 499-536.

<sup>1203</sup> The main publications on the site are Schaeffer 1952; 1971; Courtois 1986; and Dikaios 1969 (v. 1-3).

laid out on a grid plan, and ashlar masonry structures including several sanctuary buildings and the ‘Fortress’, a large structure on the northern part of the site which was heavily involved in industrial activity which included copper smelting or refining.<sup>1204</sup>

Early finds of oxhide ingots and metal scrap hoards dating to the Late Bronze Age first stimulated interest in Enkomi’s role in Late Cypriot metallurgy. Well over a ton of bronze and copper have been recovered from the site, much of it in twelve hoard deposits found on the site.<sup>1205</sup> Knapp et al. note that these hoard deposits represent well over half of the twenty-two Late Cypriot hoards dating to c. 1250-1150 B.C. on the island.<sup>1206</sup> At least three complete oxhide ingots from hoards are believed to have come from Enkomi, as well as several oxhide ingot fragments in founder’s hoards and at least five miniature oxhide ingots, some with inscriptions in ‘Cypro-Minoan’; the latter may have originally come from foundation deposits, such as those found in Egyptian Thebes, or were perhaps used as votives.<sup>1207</sup> Other hoards were uncovered during excavations of LC tombs and in sanctuary structures such as the ‘Sanctuary of the Ingot God’ and the ‘Sanctuary of the Horned God,’ named after a giant 11 kg statue found in a pit in the structure.<sup>1208</sup>

<sup>1204</sup> Negbi 1986, 101-5.

<sup>1205</sup> Catling 1964, 292; Knapp et al. 1988, 250.

<sup>1206</sup> Knapp et al. 1988, 250.

<sup>1207</sup> Catling 1964, 268-9, 280-4, 290; Masson 1971; Dikaios 1969: IIIa, Pl. 148, n. 4-5; Muhly et al. 1980, 90; Knapp 1986, 25-7; Muhly 1991, 181.

<sup>1208</sup> Catling 1964, 278-93; Schaeffer 1952; 1971; Dikaios 1969:1; 1971:2; 1969:3a, Pl. 43, 139-44; Knapp 1986, 13-4; Courtois 1986.

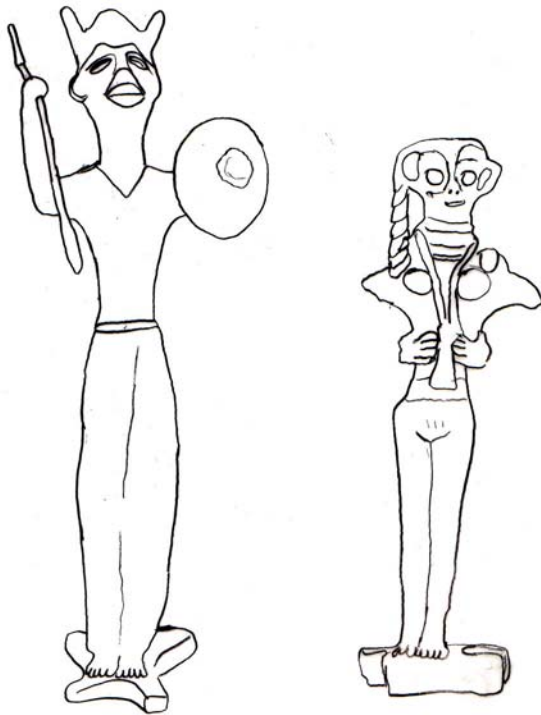

**Figure 30: The ‘Ingot God’ from Enkomi and the ‘Bomford Goddess’ (After Karageorghis 2002, 96).**

Excavations by Schaeffer uncovered a presumed temple precinct dubbed “Sanctuary of the Ingot God” in the center of the town.<sup>1209</sup> The structure was named after a bronze statuette of a male warrior figure discovered in the structure, brandishing a spear in a ‘smiting’ pose well known among Near Eastern bronze figures; significantly, this figure appears to be standing on an oxhide ingot (Figure 30).<sup>1210</sup> While it has been suggested that the ‘ingot’ is no more than a device for connecting the statuette to a

<sup>1209</sup> Courtois 1971, 151-366; Negbi 1986, 103.

<sup>1210</sup> Schaeffer 1971, 506-12, Pl. I-VII, XII-XVIII; Catling 1971, 15-7; Courtois 1971; Negbi 1976; Muhly 1980b; Webb 1999, 102-13, 223-34.

pedestal, miniature oxhide ingot finds and other evidence pointing to a ritual or religious role for oxhide ingots makes this hypothesis unlikely.<sup>1211</sup>

Two other Late Cypriot bronze statuettes, both female, also appear to stand on oxhide ingots. One, the ‘Bomford statuette,’ dated stylistically to the 12th century B.C., and presumed to come from Enkomi (Figure 30), also stands on an ingot, while the other, from Palaepaphos-*Teratsoudhia*, is stylistically similar to the Bomford statuette, is roughly contemporary with the ‘Ingot God’ (stylistically it is dated to the 13th century B.C.), and appears to stand on an ingot which has had several of its horns broken off.<sup>1212</sup> Several more fragmentary female statuettes of a similar style are also known from Cyprus, as well as terracotta examples that have a similar pose in which the figure grasps her breasts.<sup>1213</sup> Catling proposes the existence of a cult of a male warrior god and female fertility goddess associated with Cypriot copper production to explain these discoveries, while Knapp properly points out that some caution in interpreting these finds is necessary and that reconstructions of this cult activity remain highly speculative without additional evidence.<sup>1214</sup> However, it seems that the basic premise of a connection between oxhide ingots and metallurgy on the one hand and religion, perhaps some concept of fertility (related to the productivity of the copper mines?) is sound. Webb has recently proposed that the ‘Sanctuary of the Ingot God’ was dedicated to a female deity as well as the ‘Ingot God,’ based on finds of terracotta sculpture of female figures and a concentration of terracotta figurines in one area of the structure.<sup>1215</sup>

<sup>1211</sup> Muhly 1980, 42; Knapp 1986, 80-4.

<sup>1212</sup> Karageorghis 2002, 96; Catling 1971, 17-9.

<sup>1213</sup> Catling 1971, 21-9; Webb 1999, 210-6; 2001.

<sup>1214</sup> Catling 1971, 29-32; Knapp 1986, 2, 10-2, 23-4.

<sup>1215</sup> Webb 2001, 76.

Representations of individuals carrying oxhide ingots on two Cypriot bronze stands support an interpretation of a symbolic role for oxhide ingots in Late Cypriot society. One four-sided stand, probably from Kourion, shows a man carrying an oxhide ingot in what appears to be a procession to a tree; on the other side, a seated figure holding a harp faces a second tree.<sup>1216</sup> Another example, possibly from Enkomi and dating to the Late Cypriot IIIA period, shows a similar figure carrying an oxhide ingot in a procession, probably to a sacrifice; another figure carries a sheep, while a second sheep walks by the man's legs; before the ingot carrier is a figure carrying a spouted vessel, while a figure whose upper body is missing leads the procession.<sup>1217</sup> A fragment from another four-sided stand at the Ontario Museum in Toronto is of an oxhide ingot bearer similar to the other two known from Cyprus (Figure 31), while smaller fragments of similar figures have been identified in deposits of bronze scrap in a probable sanctuary at Tel Nami in the southern Levant, dating to the 13th century B.C.<sup>1218</sup>



**Figure 31: Oxhide ingot bearer in the Royal Ontario Museum, 12th century BC (After Karageorghis 2002, 97).**

<sup>1216</sup> Karageorghis 2002, 99.

<sup>1217</sup> Karageorghis 2002, 99.

<sup>1218</sup> Karageorghis and Pappasavvas 2001, 339-41; Artzy 1994, 127.



Bronze stands and tripods began as distinctly Cypriot products in this period, but were eventually produced elsewhere in Crete, Greece, and Sardinia, and influenced contemporary bronze ritual objects in the Levant.<sup>1219</sup> These objects certainly had some sort of ritual function beyond that of displaying the owner's wealth.<sup>1220</sup> These objects are typically found in Cypriot tombs or in scrap hoards.<sup>1221</sup> The use of oxhide ingots as an artistic theme on Cypriot cylinder seals of the period may also have some symbolic or ritual significance.<sup>1222</sup>

While evidence from sanctuaries and tombs suggest a ritual significance to oxhide ingots and copper in Late Cypriot society, remains from P. Dikaios' Area III, on the northern edge of the town, provide some of the best evidence for large-scale copper production on the island. Area III, or the 'Fortress,' was erected in the early 16th century B.C.; it measured approximately 45 x 13.3 m and had very thick outer walls and a central courtyard.<sup>1223</sup> Evidence for copper smelting in the structure is first found in this period (Level IA), but becomes much more common in the LC IB (Level IB: c. 1525-1425 B.C.) where it is found "in almost all of the rooms... on successive floors" and includes finds of tuyeres, crucibles, and slag and green stained areas, stone querns, often in depressions in the floors, which may be the remains of metallurgical furnaces.<sup>1224</sup> After a second destruction c. 1425 B.C., and another rebuilding episode,

<sup>1219</sup> Artzy 1994, 95; Bass 1967, 105-7; Vagnetti 1999, 192-3; Karageorghis and Papasavvas 2001, 339-41.

<sup>1220</sup> Karageorghis 2002, 98-9; Catling 1964, 218, 223; Matthäus 1985, T. 91-112.

<sup>1221</sup> Vagnetti and LoSchiavo 1989, 227-31; Catling 1964, 192-213; Bass 1967, 105-7; Artzy 1995, 28.

<sup>1222</sup> Webb 1999, 275, 278-9; Buchanan 1966, nos. 956, 974-8; Knapp 1986, 38-40, Fig. 2; Karageorghis and Kassianidou 1999, 172-3.

<sup>1223</sup> Dikaios 1971:2, 501; 1969:3a, Pl. 243-4; 1969:1, 43; 1969:3a, Pl. 8, n. 3-4, Pl. 43, n. 1-3.

<sup>1224</sup> Dikaios 1969:1, 21-32, 39, 42, 44; 1971:2, 501-2. Similar depressions are found in subsequent layers (e.g., Dikaios 1969:1, 56-7).

the structure was reoccupied (Level IIA). Copper metallurgy continued in this period, as well as into the subsequent LC IIC (Level II B: c. 1300-1230 B.C.), when Dikaios reconstructs the Fortress (perhaps incorrectly) as becoming an elite residence which, however, also produces “copper at an unprecedented scale.”<sup>1225</sup> In this period, a large slag dump covering an estimated 80 square meters and a height of up to one meter was found at the northwestern end of the complex; slag was apparently dumped from the roof of the building onto the slag heap, intermingled with Mycenaean III B pottery and other debris.<sup>1226</sup> Dikaios believes that this represents the accumulated slag of all of the copper workshops then in operation in the building.<sup>1227</sup> Slag was also found in the courtyard area and as fill for a floor of approximately 14-15 cm depth in at least one room.<sup>1228</sup> A number of depressions, pits, and channels in the floors of rooms from this level, often showing evidence of fire and copper oxide staining, may be the remains of smelting or melting furnaces, tapping pits, or other metallurgical installations.<sup>1229</sup>

During the LC IIIA (c. 1230-1190 B.C.), the Area III structure was extensively rebuilt, with areas partitioned off into what Dikaios believes were residential units, based on the presence of hearths, benches, and other domestic features in these new divisions; the copper workshops were no longer used and a new structure was built on a slag heap in the area.<sup>1230</sup> In this period until the area’s abandonment c. 1100 B.C., copper

<sup>1225</sup> Dikaios 1969:1, 65-6; 1971:2, 506-12.

<sup>1226</sup> Dikaios 1969:1, 46, 56-62.

<sup>1227</sup> Dikaios 1969:1, 61.

<sup>1228</sup> Dikaios 1969:1, 61.

<sup>1229</sup> Dikaios 1969:57. Dikaios provides dimensions for many of these features. He also notes that the floor of one of these areas is of “rammed earth” (Dikaios 1969:1, 60); perhaps suitable for the fabrication of ingot molds? According to Pulak (2001, 21), the isotopic composition of sampled copper smelting slag from Enkomi matches the lead isotope compositions of the Uluburun copper ingots.

<sup>1230</sup> Dikaios 1969:1, 80, 86; 1971:2, 515-7.

production decreased dramatically.<sup>1231</sup> Dikaios reconstructs the copper smelting activity at the site as follows:

[C]opper was smelted from the seventeenth century B.C. onwards to about 1250 B.C. in successive buildings in Area III. First (Levels A and IA) on a humble scale, later in Level IB (1525-1425 B.C.) on a fairly large scale which became much smaller in Level IIA (1425/1400-1300 B.C.)... Surely the copper smelting evidenced in the Level IIA building in Area III, could not have produced copper on a large scale, as can be inferred from the Amarna letters, although stone moulds for bun-shaped ingots [actually pot bellows] belong to this Level. During Level IIB (1300-1230 B.C.) the copper workshops had reached a peak and an impressive dump of slag laid bare in the open area to the west of the workshops, confirms the mass production.<sup>1232</sup>

Pickles and Peltenburg suggest that a major change in organization of copper working occurred during the Level II B period (c. 1300-1200 B.C.). The rooms of the Fortress' rearrangement into smaller, apparently residential units, associated with copper slag and other metallurgical remains.<sup>1233</sup> This "devolved architecture" suggest to them the "inception of a more or less autonomous family businesses specializing in copper production. It is consistent with a process of industrial devolution seen in the wider reaches of 13th-century B.C. Enkomi."<sup>1234</sup> Finds of metallurgical equipment and slag are known in other areas of the site as well, although this material was less extensively recorded and much of it remains unpublished.<sup>1235</sup> These slag finds seem to have an increasingly dispersed pattern over the Late Cypriot period, with copper production beginning to shift to Quartier 1W and other areas of the French excavation during the LC II C period, and by the LC III A period copper production has virtually ceased at

<sup>1231</sup> Dikaios 1969:1, 99, 116; 1971:2, 516-7, 524.

<sup>1232</sup> Dikaios 1971:2, 535.

<sup>1233</sup> Pickles and Peltenburg 1998, 87-9.

<sup>1234</sup> Pickles and Peltenburg 1998, 88.

<sup>1235</sup> Pickles and Peltenburg 1998, 87; Courtois 1982; 1986.

the northern part of the site.<sup>1236</sup> Pickles and Peltenburg argue that this is evidence of an increased decentralization of the copper trade, related to developments on other parts of the island as well, for example the rise of new urban centers on the island associated with the copper trade, such as Kition, and increasing amounts of foreign imports.<sup>1237</sup> Webb has proposed, based on the evidence of different sanctuaries on Enkomi, that competing elite groups came to dominate the site and copper production in the 12th century B.C., utilizing “different cult sites and ritual insignia” and appealing to “different deities in an attempt to assert ancestral authority in a destabilised environment.”<sup>1238</sup>

The slag remains from Enkomi are the most extensive known from a Late Bronze-Age Cypriot urban site. Most metallurgical sites discovered from the period, particularly in urban or settlement contexts, contain relatively little slag in comparison to the amounts that would be produced in the primary smelting of copper sulfide ore, but the slag remains at Enkomi are commonly agreed to be exceptional.<sup>1239</sup> Supplying copper to the site seems to have not been a problem; it is likely that Enkomi had control over a significant part of the interior of the island, perhaps as far as copper deposits in the Troodos Mountains, in order to sustain a significant copper export industry.<sup>1240</sup> The significance of these finds have been debated. Pickles and Peltenburg see this abundance as evidence of centralized control of copper imports into the city:

During the large-scale, centralized operations at Enkomi, we suspect that primary sources of copper ore were relatively assured and that attached metalworkers here or closer to the mines were pressured to deliver pure copper in bulk without being over-

<sup>1236</sup> Pickles and Peltenburg 1998, 88; Courtois 1982.

<sup>1237</sup> Pickles and Peltenburg 1998, 88-90.

<sup>1238</sup> Webb 2001, 79-80.

<sup>1239</sup> Karageorghis and Kassianidou 1999, 179; Dikaios 1969:1, 61; Muhly et al. 1980, 95.

<sup>1240</sup> Negbi 2005, 7; Knapp 2003, 574; Keswani and Knapp 2003, 213, 219-20.

zealous in extracting every ounce of copper from delivered raw materials. In the more competitive environment of LC IIC-III A, downsizing ensured each piece of metal became precious, so there is a concomitant intensification of scrap hoarding (at Enkomi) and transport of scrap (Cape Gelidonya wreck). Production may now have been centred on self-employed artisans and family businesses where maximizing the yields of saleable products from the available materials would be more important than minimizing labour input. One way to achieve enhanced production levels was to expend more effort on extracting copper from iron-rich ores and mattes.<sup>1241</sup>

These authors propose that the use of a prill production process, in which non-tapped slags are produced, then pulverized to retrieve copper prills or mattes, became dominant at Enkomi.<sup>1242</sup> This has been proposed earlier by Muhly et al. to explain the relative lack of slag on most urban sites with metallurgical remains (such as Kition),<sup>1243</sup> and copper has been smelted experimentally in a crucible in this way to produce slag structures very similar to those seen on the ‘crucible’/furnace lining from Enkomi and a crucible fragment from Kition.<sup>1244</sup> However, a change in the favored copper production technology could have many other reasons. The composition of oxhide ingots seems to conform to Pickles and Peltenburg’s hypothesis for the earlier stages of the copper trade, when “metalworkers... were pressured to deliver pure copper in bulk without being over-zealous in extracting every ounce of the copper [or alternatively, removing every ounce of impurities?] from delivered raw materials.”<sup>1245</sup>

<sup>1241</sup> Pickles and Peltenburg 1998, 90; Webb 2001, 79.

<sup>1242</sup> Pickles and Peltenburg 1998, 90.

<sup>1243</sup> Muhly et al. 1980, 95.

<sup>1244</sup> Zwicker 1985, 404-7.

<sup>1245</sup> Pickles and Peltenburg 1998, 90. See Chapter IV for the composition of analyzed oxhide ingots. Zwicker (1985, 406) and Muhly et al. (1980, 91, 93-4) have also noted the presence of sulfide particles both in slag samples from Enkomi and Kition and from oxhide ingots from Enkomi, Mathiati, and Cape Gelidonya.

Unfortunately, the production processes used to produce slags from Enkomi and other sites are still not fully understood, and sampling of slags in order to determine copper production processes in a given period have not yet been conducted on a large-scale, systematic manner on Late Cypriot urban sites.<sup>1246</sup> Tylecote notes that slags from Cypriot sites seem to have been produced from a variety of ores and smelting processes.<sup>1247</sup> A slag heap discovered on the eastern side of Enkomi contained slag with charcoal, which was radiocarbon dated to c. 1200 +/- 150 B.C.<sup>1248</sup> The slag was also examined metallographically, and was found to contain no sulfide particles and only copper oxide particles; the copper used in the smelting process therefore likely contained little or no sulfides, either due to thorough roasting or refining or to the use of oxide ores.<sup>1249</sup> From the slag evidence at Enkomi, Zwicker *et. al.* concluded that c. 1200 B.C. the site had been used “in the beginning of copper production with small furnaces, which produced no tapping slag.”<sup>1250</sup> This is also consistent with Bachmann’s comments on slag from Hala Sultan Tekke, suggesting the possibility that a common smelting technology was in use on both sites. Impurities in Late Bronze Age slags, particularly sulfur, indicate that copper products transported to these sites probably consisted mainly of matte or partially or fully roasted sulfide ores, so that further refining of the metal was necessary.<sup>1251</sup> Several authors point out that sulfur dioxide fumes from the roasting of copper sulfide ores would have been extremely

---

<sup>1246</sup> Tylecote 1977; 1982a; Zwicker et al. 1972; Zwicker et al. 1977; Muhly et al. 1980, 86, 88, 94-5; Zwicker 1982; Stech 1982, 105; Stech et al. 1985.

<sup>1247</sup> Tylecote 1971, 58.

<sup>1248</sup> Zwicker et al. 1977, 309.

<sup>1249</sup> Zwicker et al. 1977, 309-10.

<sup>1250</sup> Zwicker et al. 1977, 312.

unpleasant in a crowded residential area, and would have killed plants such as those thought to have been planted in a courtyard next to metallurgical installations at Kition.<sup>1252</sup> The metallurgical facilities of Enkomi and Kition could have been located at the northwestern edges of the sites specifically to take advantage of prevailing winds, however.<sup>1253</sup> Crucible refining of matte, on the other hand, could probably have been conducted in settlement areas easily since it would require less fuel, time, and space; the importing and refining of partially roasted ores or partially refined matte could account for a wide range of slags produced on these sites.<sup>1254</sup> The reconstruction of Enkomi's metal production favored by Webb, and also by Pickles and Peltenburg, as becoming more decentralized perhaps fits the evidence of increased use of scrap metal more than the introduction of a new smelting technology.<sup>1255</sup> However, even this evidence is ambiguous, as the metallurgical remains from Kition show.

## 2) Kition

Kition had become a major Cypriot harbor town in Larnaca Bay on the southeastern coast of Cyprus by the LC IIC period (c. 1320-1200 B.C.) to the south of Enkomi and in close proximity to Hala Sultan Tekke, another major urban site.<sup>1256</sup> Kition reached its greatest size in the 12th century B.C., and was continuously occupied until c. 1000

---

<sup>1251</sup> Tylecote 1982a, 83-5, 87-9, 92, 99; Muhly et al. 1980, 89, 93; Karageorghis and Kassianidou 1999, 179-80.

<sup>1252</sup> Tylecote 1982a, 99; Muhly et al. 1980, 88; Karageorghis and Kassianidou 1999, 186.

<sup>1253</sup> Negbi 2005, 13.

<sup>1254</sup> Tylecote 1982a, 82-3.

<sup>1255</sup> Webb 2001, 79; Pickles and Peltenburg 1998, 90.

<sup>1256</sup> Karageorghis 2002, 57.

B.C.; eventually, the site was reoccupied by the Phoenicians about 150 years later.<sup>1257</sup> While no discoveries of oxhide ingots or ingot fragments have been made at Kition, extensive evidence of metallurgical activity has been found in two separate areas of the settlement, Areas I and II, on the northern side of the site; these remains were found in Floors IV, III, and II, and I in a different area, which date to the LC IIC-Cypro-Geometric I (c. 1320-1200 B.C.), LC III A (c. 1200-1100 B.C.—Floors IIIA and III), and LC IIIB (c.1100 B.C.—Floor II), and Cypro-Geometric I (c. 950/900 B.C.— Floor I), respectively.<sup>1258</sup> Tombs predating the LC IIC period have been found in both Areas I and II, but no evidence of structures from before the LC IIC period has been uncovered.<sup>1259</sup>

In Area I, on the northern side of the site, copper slag and ashes and the remains of two to three furnaces in the form of pits were found in the enclosed court of a structure in association with apparent bronzesmiths' workshop.<sup>1260</sup> These pits were probably used to heat crucibles for copper or bronze refining or casting; the lack of large amounts of slag suggests that metallurgical activity was on a small scale, although the area could also have been regularly cleaned of slag.<sup>1261</sup> Furnace remains (Furnace B), consisted of a depression in the bedrock measuring about 75 x 30 cm, with a depth of about 5-10 cm; throughout the courtyard in which the furnace was found were “numerous small pits and channels”, perhaps the remains of furnaces that had been

<sup>1257</sup> Karageorghis and Demas 1985, 279; Sandars 1985, 152.

<sup>1258</sup> Karageorghis and Demas 1985, 24; Stech et al. 1985, 388-400; Karageorghis 2002, 5, 143.

<sup>1259</sup> Karageorghis and Demas 1985, 24.

<sup>1260</sup> Stech et al. 1985, 388-93.

<sup>1261</sup> Stech et al. 1985, 392-3.



used and subsequently dismantled.<sup>1262</sup> In a neighboring room (Room 39), which the excavator reconstruct as a courtyard, a second furnace was found (Furnace C), consisting of “two pits within a large oval area covered with ashes” and associated with copper slag.<sup>1263</sup> In Room 41, which also adjoined Room 40 and may have been an open or partially roofed area, a third furnace (Furnace A) was discovered adjacent to a wall; the north end of the furnace consisted of a circular pit, 70 cm in diameter and 1.2 m deep.<sup>1264</sup> The pit extends to the south another 30 cm, but only at a depth of about 20 cm; this extension was bordered by “a thick level of *havara* [local limestone bedrock] which rose 0.10 m above floor level,” while the southern end of the furnace consists of another pit “which joins to a channel running below the shallow extension of the northern pit ... and thus connects with the northern pit”<sup>1265</sup> This arrangement may have housed a downward-pointing tuyere, a furnace, and slag-tapping pit, as suggested by Tylecote.<sup>1266</sup> Copper slag was found in other parts of Area I, though no other metallurgical remains were found; it was most likely used as a paving material for another open space.<sup>1267</sup> In the succeeding period (Floor IIIA), the copper working installations were abandoned and the structure rebuilt.<sup>1268</sup>

Area II was located on the northern part of the settlement, adjacent to the city wall.<sup>1269</sup> The first architectural remains date to the LC II period, and the area was occupied continuously through much of the 10th century B.C. and abandoned until the

<sup>1262</sup> Karageorghis and Demas 1985, 6-7, Pl. VII:1, Pl. 7.

<sup>1263</sup> Karageorghis and Demas 1985, 7, Pl. 23:2.

<sup>1264</sup> Karageorghis and Demas 1985, 7-8, Pl. 8:2.

<sup>1265</sup> Karageorghis and Demas 1985, 8, 10, Pl. 8: 2, 8:3.

<sup>1266</sup> Tylecote 1982a, 91.

<sup>1267</sup> Karageorghis and Demas 1985, 8.

<sup>1268</sup> Karageorghis and Demas 1985, 10-1.

<sup>1269</sup> Karageorghis and Demas 1985, 24.

Phoenician occupation of the ninth century B.C.<sup>1270</sup> This area was used as a temple precinct beginning in the LC IIC period, which had adjoining workshops beginning in the LC IIIA period, according to the excavators, when the complex was rebuilt.<sup>1271</sup>

The Floor IIIA structure was a large, dominating edifice along the northern wall of the city, which served as a temple or sanctuary with adjoining workshops.<sup>1272</sup> In this period, the complex consisted of a pair of “twin” temples (Temples 1 and 2) linked by a temenos or entrance hall (Temenos B), probably designed as a “grand entrance hall” for the temple.<sup>1273</sup> Ashlar masonry was first used in the Floor IIIA reconstruction of Temple 1.<sup>1274</sup> The clearest evidence for metallurgical activity in Floor IIIA occurs in Room 12 of the Northern Workshops. In this room, a pair of probable workbenches had been constructed as well as the remains of a small clay-lined pit (pit E-- approx. 50 x 30 cm, and 5 cm deep) which had “bits of a greenish substance (copper?) adhering to it.”<sup>1275</sup> Between the workbenches was built a furnace (Furnace J), consisting of a pit (95 cm in diameter and 26 cm deep) with a clay lining and a mudbrick border around at least a part of the pit’s rim; the pit was later filled with ashes, including bone-ash, probably in the Floor III occupation.<sup>1276</sup> Large amounts of burnt bone were found; these were probably used as fuel or possibly as a deoxidant during refining or casting.<sup>1277</sup> Several other pits were excavated in the immediate vicinity. These were

<sup>1270</sup> Karageorghis and Demas 1985, 24.

<sup>1271</sup> Karageorghis and Demas 1985, 24, 24-81; Knapp 1986, 47-8. The excavators state that “considerable quantities” of copper slag as well as a fragmentary crucible were found in the Floor IV level, however, indicating that some copper metallurgy may have taken place at the site or nearby (Karageorghis and Demas 1985, 30-1, 37).

<sup>1272</sup> Karageorghis and Demas 1985, 89-90.

<sup>1273</sup> Karageorghis and Demas 1985, 90.

<sup>1274</sup> Karageorghis and Demas 1985, 92.

<sup>1275</sup> Karageorghis and Demas 1985, 81-2.

<sup>1276</sup> Karageorghis and Demas 1985, 82, Pl. 59.

<sup>1277</sup> Stech et al. 1985, 393-4; Tylecote 1982a, 82; Karageorghis and Kassianidou 1999, 178, 180-3.

full of debris which included ash, slag, and “greenish-coloured sand”; the pits range from approximately 30-65 cm in diameter and from 5-18 cm deep.<sup>1278</sup> A “huge stone anchor... of burnt coarse conglomerate” was also situated in the room in Floor IIIA; a smaller anchor and three fragmentary skulls and five horns were associated with the anchor; the excavators suggest that it had “religious significance.”<sup>1279</sup> Copper slag was also found between Floors IIIA and III, in the small pits, and in neighboring rooms.<sup>1280</sup>

Tylecote (1971; 1977) identified pieces of “skull-shaped slag” in the form of plano-convex blocks in Area II, in some cases cemented to walls, as tap slag; no sign of the furnaces which produced this slag were found, however.<sup>1281</sup> Complete examples would measure approx. 26 x 20 cm, with a thickness of 16 cm and an estimated weight of 11 kg.<sup>1282</sup> This slag seems to have been tapped into sandy pits, and was found to contain particles of precipitated copper and matte; Tylecote states that it was smelting slag either produced on the site or brought there, probably for further refining.<sup>1283</sup> Furnace slags that had cooled slowly within a furnace, as well as furnace conglomerate—a mixture of ore, fuel, and other materials that had fused together during an unsuccessful smelt—were also recovered.<sup>1284</sup> The slags collected at the site are a somewhat heterogeneous group, suggesting that several types of metallurgical operations were performed there and perhaps several types of ore were smelted or refined.<sup>1285</sup>

<sup>1278</sup> Karageorghis and Demas 1985, 82-3.

<sup>1279</sup> Karageorghis and Demas 1985, 83, Pl. XCVI:1.

<sup>1280</sup> Karageorghis and Demas 1985, 83-4.

<sup>1281</sup> Tylecote 1971, 53; 1977, 320; Stech et al. 1985, Pl. A-C.

<sup>1282</sup> Tylecote 1982a, 89; Koucky and Steinberg 1982b, 118.

<sup>1283</sup> Tylecote 1982a, 89-92; Stech et al. 1985, 399-401.

<sup>1284</sup> Stech et al. 1985, 397-9; Pl. A.

<sup>1285</sup> Stech et al. 1985, 395, 397-401, Pl. A-C; Zwicker 1985.

Kition, like Enkomi, provides evidence of a significant scale of metallurgical activity in temple or elite contexts. Slag, scrap bronze, and metallurgical debris have been found at other sites, such as at Kalavassos *Ayios Dhimitrios*, *Toumba tou Skorou*, *Kalopsidha Koufos*, and *Maa-Palaekastro*, but these and several other instances seem to be the result of small-scale metallurgy, probably to produce objects for the local community rather than for export, and are not as clearly associated with an elite context.<sup>1286</sup> There is little evidence of large-scale smelting at Kition in the temple area, although some smelting slags have been identified from other parts of the site, and a fragment of a crucible used for smelting was recovered in the temple area.<sup>1287</sup> The slag remains seem to have been the result of a variety of operations, but seem to indicate that refining rather than primary smelting operations most commonly took place there; in addition, tin-rich slag and bronze scrap were also found.<sup>1288</sup>

Stech (1982, 112-3) has interpreted the variety of slag and partially refined materials such as furnace conglomerate and matte as evidence of strict central control over all stages of the production and sale of copper: “Copper provided the economic means by which Cyprus could participate in Eastern Mediterranean commerce, and it was therefore regarded as something over which control was desirable.”<sup>1289</sup> The transport of partially refined copper products such as those found at Kition is ostensibly

<sup>1286</sup> South 1989, 320; Åström 1966, 115; Vermeule and Wolsky 1990, 122, 128; Knapp 1986, 52. Webb (1999, 237) argues that slag and scrap metal on Late Cypriot sanctuary sites “can have no practical function in a ritual context and may be presumed to be votive or symbolic in character.” This is certainly incorrect for Kition and perhaps other sites; however, the premise that metallurgical waste could be used as votives is sound. At the Temple of Hathor at Timna, in addition to a casting installation (1988, 64-5, Pl. Pl. 68-9) and a mass of ore nodules heaped against a wall (66, Pl. 66) copper spills and minerals were apparently deposited as votives; both smelting and refining slags were also found, as well as metallurgical equipment including crucibles and querns and hammerstones for the beneficiation of ore (Rothenberg 1988, 200-3, 266, 268-9). Such material does not prove the existence of a temple-related industry, although it is certainly likely (Rothenberg 1988, 277).

<sup>1287</sup> Karageorghis and Kassianidou 1999, 179, 186; Stech et al. 1985; Zwicker 1985, 404.

<sup>1288</sup> Karageorghis and Kassianidou 1999, 174-7, 179; Zwicker 1985, 407-11.

<sup>1289</sup> Stech 1982, 112-3; Stech et al. 1985, 398; Zwicker 1985.

inefficient. Stech et al. estimate that a caravan of fifty donkeys would be necessary to carry all the fuel, ore, and fluxes to a smelting and refining site in order to produce a mere 10 kg of copper.<sup>1290</sup> Significant planning would be required to mobilize these kinds of resources on a regular basis, and would probably require the participation or approval of a central authority. The costs of maintaining such an operation may have been offset by the guarantee of a steady supply of metal and the control that could be exerted over the copper production process once the materials were in the city. Such elaborate preparations are likely to be made only if they would bring even greater profits; thus, it appears that such centralization of the copper trade was initiated by profit-minded elites.<sup>1291</sup>

Karageorghis and Kassianidou come to a similar conclusion. They identify the Kition temple workshop as part of a temple-based recycling operation, where scrap metal collected from various sources, including older tombs and votive offerings to the temples, were processed into new objects during the 12th century B.C., possibly for export.<sup>1292</sup> Metal in tombs and from votives would be an easily obtained source of metal in addition to newly-smelted material arriving from the interior. The disposal of metal votives for profit is a likely feature of this production; Temple 2 was in use for several centuries, and would likely have accumulated a large number of votives which would have been occasionally disposed of, as figurines and sculpture found in *bothroi* of the Late Bronze Age and later demonstrate.<sup>1293</sup> A Linear B text from Pylos may

<sup>1290</sup> Stech et al. 1985, 399.

<sup>1291</sup> Stech et al. 1985, 398.

<sup>1292</sup> Karageorghis and Kassianidou 1999, 172-3.

<sup>1293</sup> Karageorghis and Kassianidou 1999, 183-6. See Rothenberg 1988, (29, Pl. 6) for a probable *bothros* from the New Kingdom period Temple of Hathor at Timna; this hoard of votive objects included pottery, faience, beads and jewelry, copper ore and slag as well as charcoal and animal bones. The absence of metal artifacts in this collection may be significant—the temple could have recycled old votives in a casting furnace at the site—but metal votives which were perhaps part of another

provide evidence of similar activities on Mycenaean sites (see Chapter II).<sup>1294</sup> Recycling of metals as a temple-based activity also seems to have occurred at contemporary sanctuary sites in the Levant, including Akko and Tel Nami.<sup>1295</sup> A casting installation at the New Kingdom period Temple of Hathor at Timna may have been used to make votive objects.<sup>1296</sup> Perhaps similar activities could have been carried out at Kition; the temple could even profit from the sale of metal votives to worshippers. Cypriot sanctuaries seem to have adopted many aspects of Near Eastern cultural influences, particularly in elite and religious structures and in votive offerings; perhaps temple industries such as the recycling of metals were adopted as well.<sup>1297</sup> The apparently ritual context of the metallurgy evidence from Enkomi, Kition, and several other sites indicates that a clear distinction between economic and ritual activity was not necessarily recognized in some cases by Cypriot elites in these settlements.

In addition to Enkomi and Kition, two other major Late Cypriot centers, Hala Sultan Tekke and Kalavassos, may have played important roles in copper production and export in the Late Cypriot period. Unfortunately, little intact metallurgical evidence has survived from these sites.

---

group of discarded votives, this in a pile of ore nodules, were found in other areas (Rothenberg 1988, 66).

<sup>1294</sup> Knapp 1986, 49.

<sup>1295</sup> Artzy 2000, 27-8. While no clear evidence of recycling of other metallurgical activities occur at the New Kingdom period Temple of Hathor at Timna, many of the votives are strongly metallurgical in character (querns and hammerstones probably used for ore beneficiation, lumps of ore possibly meant as votives, a deposit of ore nodules, copper spills, crucibles, etc.), doubtless reflecting the worshippers' professions (Rothenberg 1988, 147-203, 266, 268-9, Pl. 126, 128, 155). A casting installation (64-5, Pl. 68-9) was also found during the excavation. Webb (1999, 300-1) notes that metallurgical equipment and waste could appear as votives on Cypriot sanctuary sites as well; although slag and other metallurgical materials are known from a variety of LC sanctuary sites, including Athenioun and Kalopsidha Koufos, only Temple 1 at Kition has clear evidence for metallurgical activities within a temple complex.

<sup>1296</sup> Rothenberg 1988, 242.

<sup>1297</sup> Negbi 2005, 9-13; Hult 1983; Knapp 1986, 6-9, 15-24, 43-56; Webb 1999, 223-37.

### 3) Hala Sultan Tekke

Like Enkomi and Kition, Hala Sultan Tekke was a major coastal settlement which was founded in the MC III period and gained prominence in the Late Cypriot period (LC IA-LC IIIA); it is in fact much larger than Enkomi, although less extensively excavated.<sup>1298</sup> Hala Sultan Tekke is located on the east coast of Cyprus on Larnaca Bay, only three kilometers from Kition; their proximity and the fact that Kition was founded in the LC IIC period, during the period of major urban expansion on the island, suggests that Kition may have been founded as a second port for Hala Sultan Tekke, or perhaps a rival urban center.<sup>1299</sup> Metallurgical remains from the site are ambiguous and poorly preserved, but it appears that smelting or metal-refining activities took place at a large scale.<sup>1300</sup> Besides evidence for an undetermined number of small bronzesmiths' workshops, large amounts of copper slag, probably from smelting, were found scattered across the site in early 14th- to late 12th-century B.C. contexts, often in ploughed-up strata or in Bronze Age refuse pits, wells, and domestic spaces; these remains date from the 16th to 12th centuries B.C.<sup>1301</sup> Unlike the finds at Enkomi and Kition, no potential ritual or religious association of slag or metallurgical materials were apparent.<sup>1302</sup> Reconstruction of slag pieces from one area of the site indicate the slag was formed in conical pits, perhaps tapping pits; Bachmann and Tylecote believe this was from primary or matte smelting of roasted sulfide ore,

<sup>1298</sup> Negbi 1986, 105; 2005, 4; Knapp 1993, 1997; Keswani 1993. Negbi (2005, 3) notes that "With the exception of Enkomi and Kition... which were protected by massive walls and solid towers... excavations of other urban sites [on Cyprus] are mostly restricted to small soundings that seldom extend to the edges of any given site. Therefore, the size of many urban centers on Cyprus is highly tentative." Other sites, such as Toumba *tou Skorou*, have experienced extensive destruction due to modern activity such as plowing (Vermeule and Wolsky 1990; Negbi 2005, 16).

<sup>1299</sup> Negbi 1986, 105.

<sup>1300</sup> Åström 1982, 177-8, 183.

<sup>1301</sup> Åström 1982, 177-8; 2000, 33-4; Tylecote 1982a, 87. For a full index to the metallurgical finds from the site, see Åström 1989, 118, 130.

<sup>1302</sup> Åström 1982, 178.

possibly in “small, bowl-shaped furnaces.”<sup>1303</sup> Several types of smelting processes may have occurred on the site; both tap slag and furnace slag have been identified at the site.<sup>1304</sup> Unfortunately, little remains of the original context of the slag and other metallurgical remains; it appears that the original inhabitants destroyed or moved much of this material on their own, and subsequent ploughing has destroyed many of the archaeological contexts on the site as well. Nonetheless, it is clear that Hala Sultan Tekke was involved in some significant metallurgical production in the Late Bronze Age and, based on the small amounts of slag that have been analyzed, this production consisted partly of smelting copper sulfide ore or perhaps some impure intermediate product derived from sulfide ore.

The LC site of Toumba *tou Skorou* in northwestern Cyprus may have played an important role in copper trading networks of the Late Cypriot period.<sup>1305</sup>

Unfortunately, the site has been largely destroyed by modern agricultural development, but fragmentary architectural evidence and relatively large amounts of foreign imports of precious materials and pottery in tombs and at the site indicate substantial contacts with the Near East and Aegean in the LC-I-II periods.<sup>1306</sup>

Fragments of monumental architecture such as ashlar blocks were also recovered from the site.<sup>1307</sup> Toumba *tou Skorou* is also fairly close to the Apliki, Ambelikou and Skouriotissa mining districts and the rich MC cemetery sites of Vounous and Lapithos, which suggests that the wealthiest area on the island during the Middle and

<sup>1303</sup> Bachmann 1976, 128; 1982, 145; Tylecote 1982a, 87; Åström 1982, 177, 179.

<sup>1304</sup> Bachmann 1976, 128; 1982, 145; Tylecote 1977, 324; 1982a, 87.

<sup>1305</sup> Vermeule 1996, 51-3; Keswani and Knapp 2003, 214-5.

<sup>1306</sup> Keswani and Knapp 2003, 214-5; Vermeule and Wolsky 1990. The site originally consisted of several mounds which were eventually leveled for orchards.

<sup>1307</sup> Vermeule 1974.



early Late Cypriot periods were in the north rather than the south and east.<sup>1308</sup> The site is landlocked today, but may have been on the seacoast in ancient times.<sup>1309</sup>

Although the only remains of metallurgical processes from the site consist of some slag pieces dating to the 13th century B.C., Keswani and Knapp have proposed it was the capital of one of at least two major copper-producing polities on the island during the Late Bronze Age.<sup>1310</sup> They represent Toumba *tou Skorou* as an administrative center in control of copper mining villages and smelting camps in copper rich areas as well as ‘agricultural support villages’ which provide food and other necessities for the city and its miners and smelters in the mountains.<sup>1311</sup> Large towns of the east coast of the island may have been rival political entities, particularly Enkomi, Kition, and Hala Sultan Tekke.<sup>1312</sup> Although this argument is based on circumstantial evidence—the location of the site, vague reports of its size, and evidence for substantial access to foreign prestige goods at a fairly early period—the site may well have been a major competitor or perhaps a predecessor of the large, wealthy settlements on the east coast.

#### *Metallurgy at Inland Settlements*

Several significant inland sites are established in the Late Cypriot period that may have had some involvement in the copper trade. All show an increase in wealth and activity in the 13th century B.C.

<sup>1308</sup> Catling 1964, 29-32.

<sup>1309</sup> Catling 1964, 30.

<sup>1310</sup> Keswani and Knapp 2003, 215; Stech 1982, 108; Vermeule and Wolsky 1990, 44.

<sup>1311</sup> Keswani and Knapp 2003, 215-20.

<sup>1312</sup> Keswani and Knapp 2003, 219-20.

### 1) Atheniou

Atheniou is located 20 km southeast of Nicosia in central Cyprus, in close proximity to major copper deposits in the Troodos mountains.<sup>1313</sup> The site was occupied from the 16th century B.C. until the first half of the 12th century B.C., with the main occupation occurring in Strata III (late 16th to late 13th century B.C.) and II (c. 1200-1100 B.C.).<sup>1314</sup> The main occupation of this site was therefore contemporary with the rise of other major centers on the island such as Enkomi, Kition, and Kalavassos *Ayios Dhimitrios*.<sup>1315</sup> The site seems to have been a cult center, based on large deposits of votive vessels, many of them crude miniature imitations of Cypriot types; over 10,000 of these were found, the largest concentration of Cypriot votive pottery found on Cyprus at a single site.<sup>1316</sup> Large numbers of imports, such as Mycenaean pottery and luxury items such as an ivory rhyton, attest to remarkably close connections to international trade networks for such a small site.<sup>1317</sup> Evidence of metallurgical activity was discovered in Strata III and II; the excavators hypothesize a connection between the metallurgical activity conducted at the site and cultic activity.<sup>1318</sup> Over a half a ton of copper ore and slag were discovered on the site, some pieces weighing as much as 25 kg.<sup>1319</sup> No clear evidence for furnaces were discovered, however, nor were any crucibles or tuyeres found; this may indicate that the material was removed during a subsequent rebuilding of the site or by later human activity, which caused considerable damage to the Bronze Age deposits.<sup>1320</sup> Most copper ore and slag on the site were found in the vicinity of the “northeastern platform”, an area of approximately

<sup>1313</sup> Dothan and Ben-Tor 1983, 1.

<sup>1314</sup> Dothan and Ben-Tor 1983, 1.

<sup>1315</sup> Dothan and Ben-Tor 1983, 139-40.

<sup>1316</sup> Dothan and Ben-Tor 1983, 139-40.

<sup>1317</sup> Dothan and Ben-Tor 1983, 46-53, 119-21, 123-5, 139-140.

<sup>1318</sup> Dothan and Ben-Tor 1983, 140.

<sup>1319</sup> Dothan and Ben-Tor 1983, 140.

<sup>1320</sup> Dothan and Ben-Tor 1983, 1, 140.

70 square meters covered by a 10 cm thick layer of lime plaster.<sup>1321</sup> The platform dates to Stratum II (c. 1200-1100 B.C.), although much of the slag and ore predate the construction of the platforms.<sup>1322</sup> The excavators interpret these remains as evidence that Athenioun “was a cultic site connected with with metalworking,” despite the ambiguous context of the slag.<sup>1323</sup> Features on the Level II platform include mudbrick benches, a line of five shallow circular depressions, and a mudbrick platform; one section of the platform was burned, and sherds of broken pithoi are associated with the feature as well.<sup>1324</sup> These pithoi apparently contained olives or olive oil.<sup>1325</sup> Two large pits filled with debris and clay and a system of channels cut into and under the platform were also associated with the feature; some of these channels were lined with stone slabs and filled with chunks of copper ore.<sup>1326</sup> The channels slope gently to the north. Their function is unknown, but may have involved some sort of industrial activity such as olive oil production.<sup>1327</sup>

Dothan and Ben-Tor, the site’s excavators, identify the feature as an industrial installation, with “metalworking and ceramics being the most obvious possibilities.”<sup>1328</sup> Muhly discounts the idea that this installation was used for roasting copper ore, pointing out that much of the copper ore seems to have been built into the platform, indicating that the roasting and/or smelting activity that resulted in these deposits occurred before the construction of the feature.<sup>1329</sup> He also rejects the

---

<sup>1321</sup> Dothan and Ben-Tor 1983, 10-1. The platform original area is estimated to have been about 120 square meters.

<sup>1322</sup> Dothan and Ben-Tor 1983, 12, 140.

<sup>1323</sup> Dothan and Ben-Tor 1983, 140.

<sup>1324</sup> Dothan and Ben-Tor 1983, 12, 139.

<sup>1325</sup> Dothan and Ben-Tor 1983, 13.

<sup>1326</sup> Dothan and Ben-Tor 1983, 12.

<sup>1327</sup> Dothan and Ben-Tor 1983, 12.

<sup>1328</sup> Dothan and Ben-Tor 1983, 12.

<sup>1329</sup> Muhly 1985b, 33-4.

suggestion that the pitthoi on the northeastern platform contained olive oil used as fuel for the roasting fires.<sup>1330</sup>

Maddin *et al.* divide the copper ore and metallurgical debris on the site into two categories: ‘nodules’, and ‘large chunks’.<sup>1331</sup> Both were the result of smelting chalcopyrite ore, the most widely available ore on the island and, according to several researchers, the only ore that was available on the island in any significant quantities, even in ancient times.<sup>1332</sup> The nodules come in two sizes: small chunks from 2-6 cm in diameter, of which about 120 kg were found, and large chunks of approximately 10 cm in diameter, of which 202.5 kg were found, about 100 kg of which were over 20 cm in diameter.<sup>1333</sup> The smaller nodules appear to date mainly to Stratum III, which is dated primarily to the 14th and 13th centuries B.C. based on pottery finds.<sup>1334</sup> The smaller nodules were deposited under the northeastern platform, concentrated in a pit in Stratum III in the main courtyard at the site, and scattered around the northern part of the courtyard.<sup>1335</sup> The larger nodules came from the eastern part of the site, beyond a platform dating to Stratum II; more nodules dating to the same period were found on the eastern part of the site.<sup>1336</sup> The larger chunks exhibit charcoal and wood impressions, and several have “rounded lower contours”, perhaps due to melting in a furnace; the diameters of some of these pieces measure between 30-40 cm, typical

<sup>1330</sup> Maddin et al. 1983, 137.

<sup>1331</sup> About 5 kg of scrap metal found in a pit dating to Stratum III were also found (Maddin et al. 1983, 134-5).

<sup>1332</sup> Maddin et al. 1983, 132, 136. This view is opposed by Gale and Stos-Gale (1994, 95-6), who cite modern discoveries of oxide and carbonate ores on the island as proof that they would have been available in significant quantities to ancient miners.

<sup>1333</sup> Maddin et al. 1983, 132, 134.

<sup>1334</sup> Dothan and Ben-Tor 1983, 139.

<sup>1335</sup> Maddin et al. 1983, 132.

<sup>1336</sup> Maddin et al. 1983, 132. Some of the smaller nodules under the northeastern platform may be assigned to Stratum II, however, although they may have ended up in this stratum due to later disturbance such as plowing.

dimensions for Bronze Age furnaces.<sup>1337</sup> Two of the small nodules that were analyzed contained structures consistent with an origin from chalcopyrite ore.<sup>1338</sup> Maddin *et. al.* propose that these nodules are the remains of larger nodules which were roasted in an open fire to remove the sulfur and break up the ore:

The roasting reaction begins on the surface of the chunks, forming a porous oxide coating. As the reaction proceeds, the oxide coating becomes thicker, increasing the difficulty of oxidizing the inner part of the ore chunk since it becomes more difficult for the sulphur dioxide to escape. The reaction slows in proportion to the thickness of the oxide layer or even reaches an equilibrium state in which no more sulphide is converted to oxide. Therefore particles with diameters of over a few centimeters will roast slowly and often incompletely. If an attempt is made to speed the roasting process by raising the temperature, sintering or fusion of the ore results, and the roasting process is retarded or stopped. Therefore, the size of the chunks to be roasted is most important. Since the progress of the roasting process cannot be judged by external appearance, it will not be surprising to find that ancient roasting operations were often incomplete, with some sulphur remaining in the ore. It is possible to smelt incompletely-roasted copper ores successfully, with the formation of a waste product called matte, which is composed of copper, iron, and sulphur. When roasting is complete or judged to be so, the ore is smelted in a reducing atmosphere to produce metallic copper.<sup>1339</sup>

This reconstruction accounts for the formation of these nodules as well as their relatively uniform size; Maddin *et al.* theorize that these chunks are the cores of chalcopyrite chunks which were roasted, then smelted; the larger pieces are ore chunks which did not oxidize during roasting.<sup>1340</sup> Ancient smelters likely stopped roasting the ore when yellow sulfur dioxide gas was no longer visibly emanating from the roasting pile, although this would not necessarily mean that all of the ore had been completely

---

<sup>1337</sup> Maddin *et al.* 1983, 134.

<sup>1338</sup> Maddin *et al.* 1983, 132-3.

<sup>1339</sup> Maddin *et al.* 1983, 133.

<sup>1340</sup> Maddin *et al.* 1983, 134.

oxidized.<sup>1341</sup> The experimental melting of two ore nodules indicate that they had originally been heated to between 1100 ° and 1270 ° Celsius; proof that the nodules had never been molten is shown by the lack of dendritic structures found in microscopic analyses, though dendritic structures were reproduced in the heating of a nodule in a crucible to 1420 ° Celsius.<sup>1342</sup> The smelting process, therefore, probably involved heating the chunks to about 1100 °, a temperature at which the ore chunks “became mushy” and the copper ore in the roasted layers began to precipitate, sinking to the bottom of the ore chunk and the furnace and separating into copper prills in the body of the ore chunk.<sup>1343</sup> Because the center of the ore chunks were not oxidized, then no copper would be found in the nodules and they would be discarded, while visible copper would be removed from the ore chunk by crushing.<sup>1344</sup> It is important to note that this process would produce no slag; the nodules themselves are the waste products.<sup>1345</sup> The two different sizes of the ore chunks may also represent two different stages of in the copper smelting process; the larger chunks may have been the original ore chunks to be roasted and smelted while the smaller pieces underwent roasting and/or smelting several times.<sup>1346</sup> Copper-iron sulfide particles within analyzed scrap copper and bronze also found at the site would be consistent with the smelting process described above, suggesting the possibility that finished objects were

---

<sup>1341</sup> Maddin et al. 1983, 136.

<sup>1342</sup> Maddin et al. 1983, 133.

<sup>1343</sup> Maddin et al. 1983, 134.

<sup>1344</sup> Maddin et al. 1983, 134, 136.

<sup>1345</sup> Maddin et al. 1983, 137.

<sup>1346</sup> Maddin et al. 1983, 134.

also made at the site.<sup>1347</sup> This smelting method has not been experimentally tested, however.

Thin sections of the larger chunks show the beginnings of the formation of dendritic structures, indicating that the larger chunks were heated to higher temperatures (about 1200 ° Celsius). Although essentially the same process was used on the larger chunks as on the nodules, this evidence shows that a larger yield of copper was obtained from the ore and therefore it was processed in a more efficient way.<sup>1348</sup> This technological improvement indicates that smelting technology had improved in the Stratum II period though the smelting methods used were basically the same as in Stratum III.<sup>1349</sup>

Maddin *et al.* estimate that this method could have produced about 150 kg of copper from about 600 kg of chalcopyrite ore in which the proportions of copper, iron, and sulfur were equal, making this a fairly efficient smelting method.<sup>1350</sup>

The site's excavators state that "Atheniou must be understood as a station on the trade route leading from the mining area to the large marketing centers on the east coast of the island. The variety of the finds, astonishing for such a small inland site, testifies to close connections with these coastal centers, and through them, with the cities of the Aegean and eastern Mediterranean."<sup>1351</sup> The large amount of metallurgical debris indicates that a substantial amount of copper production took place on the site.

---

<sup>1347</sup> Maddin et al. 1983, 136.

<sup>1348</sup> Maddin et al. 1983, 134.

<sup>1349</sup> Maddin et al. 1983, 137.

<sup>1350</sup> Maddin et al. 1983, 137.

<sup>1351</sup> Dothan and Ben-Tor 1983, 140.

However, much more slag would have been present if a large number of oxhide ingots had been produced from primary ore on the site; perhaps additional copper production took place in the surrounding area and the copper was collected at Atheniou before being sent elsewhere. If so, then the metallurgical debris from Atheniou could represent only a small fraction of the total amount of copper to pass through the settlement. Whether it has any connection with the operation of the sanctuary is unclear, however. It is also unclear how common the smelting method used at the site was; so far, it is the only recognized example of this type of metallurgical treatment known.

## 2) Kalavastos *Ayios-Dhimitrios* and Maroni *Vournes*

Kalavastos *Ayios-Dhimitrios* is located in the Vasilikos Valley in southern Cyprus; its main occupation dates to the Late Cypriot IIC period (c. 1300-1190 B.C.).<sup>1352</sup> The site is located about 8.5 km away from the copper mines at Kalavastos near the Vasilikos River and about 3.5 km north of the coast; it is thought to have originally covered an area of about 11.5 ha.<sup>1353</sup> These ore deposits, as well as the intersection of two natural avenues of communication at the site, were likely the reasons for the site's importance; activity at the mines could be coordinated and supervised from the site and communication with the outside world, particularly with the nearby LC site at Maroni *Vournes* on the coast in an adjacent valley, could be easily maintained.<sup>1354</sup> The importance of these copper deposits likely extended back into the Middle Cypriot

<sup>1352</sup> South 1980, 23, 48-9; 1989, 317, 319; 1997, 152, 161.

<sup>1353</sup> South 1980, 23, 25; 1989, 319.

<sup>1354</sup> South 1980, 51; Cadogan 1989, 43.



period, as indicated by relatively large amounts of bronze finds in tombs in the Vasilikos Valley dating to this period.<sup>1355</sup> Major settlement at the site of Kalavasos *Ayios-Dhimitrios* seems to have begun during the LC II period.<sup>1356</sup> The site was abandoned around 1200 B.C. and not reoccupied.<sup>1357</sup>

Many features found at Kalavasos *Ayios Dhimitrios* are also found at Maroni-*Vournes*. Based on pottery finds from the site, Maroni-*Vournes* was occupied slightly earlier (LC IA period) and abandoned slightly earlier than Kalavasos *Ayios-Dhimitrios*, before the beginning of the LC III period.<sup>1358</sup> Near *Vournes* is Maroni-*Tsaroukas*, a settlement site 500 m away probably associated with the important buildings at *Vournes*; these include the ‘Basin Building’, containing a unique basin of unknown function (found with “copper debris” at its bottom), and the Ashlar Building, a large structure measuring approximately 30.5 x 20 m and with external walls built with finely dressed ashlar blocks to a thickness of up to two meters.<sup>1359</sup> The Ashlar Building is thought by the excavator to have been two or more storeys due to the thickness of the walls, although almost all of the original stone has been robbed; in its original form, it would have been a highly visible and imposing structure.<sup>1360</sup> Remains of the floor and other features of a large building were found below the 13th-century Ashlar Building; these, combined with rich tombs of LC IIA-B date excavated in the

<sup>1355</sup> South 1989, 316-7.

<sup>1356</sup> South 1989, 317.

<sup>1357</sup> South 1989, 322-3.

<sup>1358</sup> Cadogan 1996, 20; 1998, 8.

<sup>1359</sup> Cadogan 1996, 16-7. “Many of the internal and some of the external walls” were made of mud brick and mortar (Cadogan 1989, 46).

<sup>1360</sup> Cadogan 1989, 45; 1998, 8.

area, indicate that an established elite had developed in the area sometime before the 13th century BC.<sup>1361</sup>

Pottery evidence indicates the Ashlar Building was built early in the 13th century B.C., making it one of the earlier examples of true ashlar masonry on the island.<sup>1362</sup> The building seems to have been divided into domestic, storage, and production areas involved in the pressing of olive oil.<sup>1363</sup> Metallurgical debris was also found in the central ‘courtyard’ area, although much of it appears in fill thought to predate the construction of the building.<sup>1364</sup> Metallurgical material from the site includes slag from “secondary smelting (much furnace charge) and melting” as well as four oxhide ingot fragments with characteristics of Cypriot copper, in association with fragments of Canaanite jars.<sup>1365</sup> Finished bronze objects and scrap metal were also found in the LC IIC layer of metallurgical debris, though the excavator states that none of the metallurgical evidence “suggests that copper was worked inside the building.”<sup>1366</sup>

Both Maroni *Vournes* and the larger town of Kalavassos *Ayios Dhimitrios* were clearly regional centers in the 13th century B.C. Many of the Late Cypriot tombs excavated nearby were built for local elites. Although these tombs were partially looted, they have revealed rich finds, including gold, silver, lapis lazuli, glass, faience, and amber jewelry, as well as Mycenaean import pottery, bronze and ivory objects, fragments of alabastara, and seals.<sup>1367</sup> A child’s burial dating to the 13th century B.C. was

<sup>1361</sup> Cadogan 1996, 16.

<sup>1362</sup> Negbi 2005, 7-8; Hult 1983.

<sup>1363</sup> Cadogan 1989, 46-7; 1996, 16.

<sup>1364</sup> Cadogan 1996, 17.

<sup>1365</sup> Cadogan 1989, 47; 1996, 17; Muhly et al. 1988, 285.

<sup>1366</sup> Cadogan 1996, 17; 1998, 8.

<sup>1367</sup> South 1980, 44; 1989, 318; 1997, 163-5; Karageorghis 2002, 34, 36.

discovered near Building X; it contained a rare Hittite silver figurine, indicating that the burial was for a member of an elite group, perhaps local nobility.<sup>1368</sup> *Ayios Dhimitrios* shows some degree of planning in its construction, including streets aligned on a grid plan similar to that of Enkomi, as well as a variety of items such as bronze objects and imported pottery.<sup>1369</sup> Building X in the northeast area of the site was constructed with ashlar masonry.<sup>1370</sup> Like the Ashlar Building at Maroni-*Vournes*, Building X is clearly an example of monumental architecture (it is about 30 x 30 m, with some of the ashlar blocks as long as 3.2 m), probably for the use of the ruling elites of the settlement as a residence and administrative center.<sup>1371</sup> The structure was built around a central courtyard and includes a large storerooms containing 47 pithoi; several long Cypro-Minoan inscriptions on clay tablets were also found as well as large amounts of imported Mycenaean pottery and other high-status goods.<sup>1372</sup> The structure was rebuilt at least once in its history, and may predate the LC IIC period.<sup>1373</sup> The main occupation evidence dates to the LC IIC period; the site was abandoned at the end of this period and never reoccupied to any large extent.<sup>1374</sup>

South identifies Building IX on the site as a coppersmith's workshop, based on finds of a probable hearth or furnace, about 135 kg of slag in a 50 x 50 cm area, crucible or furnace lining fragments, a tuyere, and deposits of bronze tools, scrap, three oxhide

<sup>1368</sup> South 1997, 163; Karageorghis 2002, 34.

<sup>1369</sup> South 1989, 320, 322; 1997, 151-2, 154-6; Cadogan 1998, 7.

<sup>1370</sup> South 1989, 320.

<sup>1371</sup> South 1989, 322.

<sup>1372</sup> South 1989, 320-2; 1997, 151-2, 154-6.

<sup>1373</sup> South 1997, 152, 154-5. Roof beams from Building X on the site have been radiocarbon dated to the mid-15th century B.C., while dendrochronology dates on the beams range from c. 1470-1400 B.C.; however, these represent the dates in which the timber was cut and not necessarily the date of the building's construction, since roof beams could have been recycled in the construction of the building (South 1997, 172-3).

<sup>1374</sup> South 1989, 322-3.

ingot fragments and seven possible ingot fragments of a different type.<sup>1375</sup> Lead-isotope analyses of slag and metal from the site indicate that the metal used on the site was *not* from the adjacent Kalavassos deposits, however.<sup>1376</sup> A cylinder seal and hematite weight found in Building IX suggest that it represents a “small-scale, private enterprise” according to the excavator.<sup>1377</sup> Several pierced stones, one a trapezoidal stone resembling a Bronze Age anchor, were found at the site; some of these may have been used as weights for olive presses or for weighing bulk goods (including metal?).<sup>1378</sup> Other weights, including a hematite weight and a set of zoomorphic hollow bronze weights filled with lead were discovered; these were calibrated to weight standards in use in Syria and the Aegean, and the bronze weights have stylistic parallels from other sites in Cyprus, the Near East, Anatolia (the Uluburun shipwreck), Crete, and Egypt.<sup>1379</sup>

Kalavassos *Ayios Dhimitrios* was likely one of the major centers in the organization of the Cypriot copper trade, based on the wealth at the site and its proximity to the copper mines at Kalavassos and to major communication routes. The Ashlar Building at *Vournes* closely resembles the larger and more elaborate Building X at *Ayios Dhimitrios*, both in its general design (ashlar masonry, size, layout) and in the functions that seemed to have occurred in it (a probable combination of residence, industrial production and storage site, and perhaps administrative activities). The Ashlar Building may have therefore been a prototype for Building X; Cadogan suggests that Building X at *Ayios Dhimitrios* “superseded *Vournes* in importance and

<sup>1375</sup> South 1989, 320; South et al. 1989, 25-6, Fig. 22, Pl. VIII.

<sup>1376</sup> Gale 1999, 115.

<sup>1377</sup> South 1989, 320.

<sup>1378</sup> South 1980, 46.

<sup>1379</sup> South 1989, 320; Muhly 1985b, 42; South et al. 1989, 26-7, 30, Fig. 24-5, Pl. I, IX-X; Lassen 2000, 236-9.

control, making Vournes its junior partner.”<sup>1380</sup> He also notes that both would be easy to attack from the sea, a factor that likely caused their destruction or influenced their abandonment.<sup>1381</sup> A recent petrographic study of Alashian clay tablets from Amarna and Ugarit indicate that the clay used to make the tablets originated from the southern Troodos region, in the general vicinity of Kalavassos *Ayios Dhimitrios*, making it or a nearby center a possible candidate for the ‘capital’ of an Alashian state.<sup>1382</sup> However, its lack of archaeologically visible defenses (unlike Enkomi and Kition) and its proximity to the sea appear to make it a dangerous choice for the capital of a major polity.

*Alassa Pano Mandilaris* and *Paliotaverna* are further examples of the type of Late Cypriot regional centers seen at *Ayios Dhimitrios* and Maroni, located 15 km northwest of Limassol and 10 km north of the Bronze Age site of Episkopi-*Phaneromeni*.<sup>1383</sup> *Alassa* is also located close to copper-rich areas on the southern side of the Troodos Mountains; the site’s size and proximity to copper sources indicates a probable function as a major local center involved in the copper trade.<sup>1384</sup>

At *Alassa* there are two sites: *Pano Mandilaris*, the lower part of the settlement, and *Paliotaverna*, the upper part, about 20 m higher in elevation (260 m above sea level).<sup>1385</sup> Later agricultural and construction activity has destroyed much of the Bronze Age remains, making it impossible to determine the original extent of the

<sup>1380</sup> Cadogan 1998, 8.

<sup>1381</sup> Cadogan 1998, 8.

<sup>1382</sup> Goren et al. 2003, 242-4, 248-51.

<sup>1383</sup> Hadjisavvas 1996, 23.

<sup>1384</sup> Hadjisavvas 1996, 23.

<sup>1385</sup> Hadjisavvas 1989, 34.

site.<sup>1386</sup> Excavators discovered residential areas dating to the LC IIC to LC IIIA periods and three small sanctuary or cultic sites, one of which included terracotta bull figurines in association with a miniature oxhide ingot.<sup>1387</sup> A ceramic pot bellows was found in one of the habitation areas in a room adjacent to the one where the miniature oxhide ingot was found.<sup>1388</sup> Small amounts of slag and copper sulfide ore were found in at least three other areas, indicating “primary smelting” activities; however, no furnaces have been found on the site.<sup>1389</sup> Excavation of *Paliotaverna* revealed a pair of large ashlar buildings constructed along a wide, probably pre-planned, avenue; Building II, the better preserved, is approximately 30 x 7 m in area and was constructed with stones weighing up to three tons.<sup>1390</sup> The structure was burned and abandoned some time in the LC IIIA period.<sup>1391</sup> A large ‘hearth room’ showing some resemblance to a Mycenaean megaron as well as a large number of sealings with Aegean or Near Eastern motifs (chariots, lions, etc.) suggest some sort of central authority at the site, familiar with foreign prestige symbols and likely involved in administrative activities at the site.<sup>1392</sup>

#### *Late Cypriot Metallurgical Activity in Mining Areas*

Two Late Cypriot smelting sites with significant metallurgical remains have been identified.

<sup>1386</sup> Hadjisavvas 1996, 23.

<sup>1387</sup> Hadjisavvas 1986, Pl. XVIII: 3, 4, 6; 1989, 35-8; 1996, 25.

<sup>1388</sup> Hadjisavvas 1989, 39.

<sup>1389</sup> Hadjisavvas 1989, 39; 1996, 25, 28.

<sup>1390</sup> Hadjisavvas 1996, 28-34.

<sup>1391</sup> Hadjisavvas 1996, 32.

<sup>1392</sup> Hadjisavvas 1996, 34-5, 38; Steele 2004, 161.

### 1) Politiko Phorades

Politiko *Phorades* is a small primary smelting site in the northeast Troodos foothills. The site is located along an ancient creek bed, a tributary of the Kouphos River, in a heavily eroded area; it consists of a large heap of slag and gossan, some carefully stacked/deposited within the creek channel.<sup>1393</sup> The site was identified from its metallurgical debris, included tuyeres, furnace lining fragments (over 6,000 were eventually collected), the remains of a furnace, and an artificial bank constructed by the smelters, probably through the gradual dumping of slag in the creek bed.<sup>1394</sup> Over 3.5 tons of slag was recovered from the site; the composition of the cobble bank as well as the large number of snail shells found within the bank indicate that it was probably deposited over a period of time, most likely by small-scale, seasonal smelting activity.<sup>1395</sup> Several strata seem to indicate such activity on the site; Stratum 2, which consisted mostly of furnace lining fragments, may have resulted from the collapse of a furnace, while Stratum 3, located on the edge of the creek, was likely an intentional dump for industrial debris.<sup>1396</sup> Based on pottery and radiocarbon dates obtained from the site, Knapp estimates that these remains point to a use of the site for “one century or less.”<sup>1397</sup>

The furnace lining fragments recovered from the site include pieces of furnace bases and rounded rim fragments; the walls were built at an approximately 90° angle from the furnace bottom, and fingerprint impressions on the outer surfaces of some furnace lining fragments indicate that they were built above ground, and either left as

<sup>1393</sup> Given et al. 1999, 31; Knapp et al. 1999.

<sup>1394</sup> Knapp et al. 1999, 127-8; 2002, 319-20; Kassianidou 1999, 92-3; Given et al. 1999, 35.

<sup>1395</sup> Knapp et al. 1999, 127-33; 2002, 320.

<sup>1396</sup> Kassianidou 1999, 93.

<sup>1397</sup> Knapp 2003, 575.

freestanding furnaces or then lowered into depressions dug into the hillside.<sup>1398</sup> The thicknesses of these pieces vary; at least two furnace lining fragments consist of several superimposed layers.<sup>1399</sup> Radiocarbon, dendrochronology, and pottery dates indicate that the site was in use from c. 1700-1500 B.C., or the early part of the Late Bronze Age.<sup>1400</sup> Ancient plow marks were also found at the site, indicating that the area was once cultivated.<sup>1401</sup> A large conical diabase boulder was also uncovered, next to which was found a small deposit of bone; since diabase is not native to the area and the stone showed no signs of wear (from use as a grindstone, for example); the excavators suggest some sort of ritual function.<sup>1402</sup>

The slag from the site consists of plano-convex slag cakes. Copper matte, which had separated from the slag during smelting, was removed from the bottom of the slag cake.<sup>1403</sup> Intact slag cakes are estimated to have weighed about 15-20 kg each.<sup>1404</sup> Large fayalite crystals in the slag indicate that it cooled slowly, possibly in the furnace, although gravel was embedded in the slag (but not in furnace lining fragments), as well as the obtuse angles of the slag cakes' sides (which do not match evidence from furnace lining fragments that the furnaces' sides were roughly cylindrical) indicates that the slag may have been tapped into a pit next to the furnace.<sup>1405</sup> This type of slag has not been discovered on any other Cypriot site, although a similar slag was produced in smelting experiments.<sup>1406</sup> The smelting

<sup>1398</sup> Knapp et al. 1997, 260-1.

<sup>1399</sup> Knapp et al. 1997, 260-1.

<sup>1400</sup> Knapp 2003, 561-3.

<sup>1401</sup> Kassianidou 1999, 94.

<sup>1402</sup> Kassianidou 1999, 94.

<sup>1403</sup> Given and Knapp 2003, 216; Knapp et al. 1999, 137.

<sup>1404</sup> Given et al. 1999, 32.

<sup>1405</sup> Kassianidou 1999, 95-6.

<sup>1406</sup> Kassianidou 1999, 91, 96; Bamberger and Wincierz 1990, 131.



process used at Politiko *Phorades* seems to have been fairly efficient, since no large copper prills are visible within the slag cakes; this indicates that a good separation between slag and copper was attained.<sup>1407</sup> The lack of evidence for crushing slag to retrieve copper prills also indicates that fairly uniform results were achieved in smelting operations.<sup>1408</sup> Metallographic analyses of several slag samples indicate that the slag was likely produced from chalcopyrite ore, and contain no pure copper, indicating that matte was produced in the primary smelt rather than pure copper.<sup>1409</sup> Copper-iron matte has a lower melting point than copper (they melt at below 1000° Celsius, while pure copper melts at 1083° Celsius), and take longer to solidify, allowing good separation between matte and slag.<sup>1410</sup> A single piece of matte was found on the site as well, possibly a desired end-product of this smelting process; the matte piece was found to contain 73.5% Cu, 2.6% Fe, and 23.9% S, with some highly pure (99.5%) copper prills within the matte matrix.<sup>1411</sup> A piece of furnace conglomerate, possibly the result of an incomplete smelt rather than roasting of ore, was also found at the site; similar examples are known from Enkomi, Kition, Atheniou, Kalavastos *Ayios Dhimitrios*, Maroni-*Vournes* and Myrtou *Pigadhes*.<sup>1412</sup>

Extremely large tuyeres were excavated from the site, with 2-3 cm bores and up to 30 cm long; these were probably pointed directly into the open mouth of the furnace.<sup>1413</sup> An ‘elbow’ tuyere, similar to examples from Enkomi, was found at the site, as well as four double tuyeres consisting of a second layer of clay built around the first,

<sup>1407</sup> Kassianidou 1999, 95.

<sup>1408</sup> Kassianidou 1999, 95.

<sup>1409</sup> Knapp et al. 1999, 136-7.

<sup>1410</sup> Knapp et al. 1999, 137.

<sup>1411</sup> Knapp et al. 1999, 138.

<sup>1412</sup> Knapp et al. 1999, 138-9.

<sup>1413</sup> Given et al. 1999, 32; Knapp et al. 1999, 138.

presumably in an attempt to reuse or reinforce the tuyere; one has a slagged tip, indicating that it was built into a furnace wall.<sup>1414</sup> This is a design previously unknown in Cyprus (but known from New Kingdom smelting in Timna).<sup>1415</sup> Some of the slagged tuyeres have slag deposits extending to 10 cm of their length, indicating that were set deep inside the furnace.<sup>1416</sup>

Although the surrounding area is heavily eroded, roasting and ore beneficiation as well as charcoal burning probably took place nearby.<sup>1417</sup> The creek bed would supply water for the workers and water and clay for the construction of furnaces and tuyeres for the smelting operations.<sup>1418</sup> The relative lack of pottery at the site indicate that it was purely a work area and not located next to a settlement; the nearest evidence for a Bronze-Age settlement comes from Aredhiou *Vouppes* a few kilometers away, a recently identified Late Cypriot site. This site was probably an agricultural village, judging from the large number of pithoi fragments found in surface collections, and may have been the home of the smelters, or at least supplied them with food and other necessary supplies.<sup>1419</sup> The copper ore used in the smelting operations was likely mined from a nearby outcrop about 500 m from the site; since no evidence of ore beneficiation or roasting was found at Politiko *Phorades*, these activities may have

<sup>1414</sup> Given et al. 1999, 32; Knapp et al. 1997, 260-2; 1999, 140.

<sup>1415</sup> Rothenberg 1990, 41.

<sup>1416</sup> Knapp et al. 1997, 261.

<sup>1417</sup> Kassianidou 1999, 94.

<sup>1418</sup> Knapp et al. 2002, 320; Knapp et al. 1997, 260-1.

<sup>1419</sup> Knapp 2003, 569-71; Knapp et al. 1999, 134-5; Given et al. 1999, 30-1. Three possible post holes were excavated, however, perhaps the remains of a temporary shelter for the smelters (Knapp et al. 1999, 130). J. M. Webb and D. Frankel (1994, 6-7, 16-7, 20-1) believe they have located another 'agricultural support village' from the Late Cypriot period at Analiondas *Palioklichia* in central Cyprus.

been carried out at the mine, or else in an area closer to the site that has since eroded away.<sup>1420</sup>

Keswani and Knapp postulate that Politiko *Phorades* was a typical smelting site of the Late Bronze Age; many small, seasonal smelting operations could be conducted in copper-rich areas, while nearby agricultural villages would supply food, clothing, and probably miners and smelters.<sup>1421</sup> The site would likely be integrated into a larger trade network, probably centered in the LC IIC and LC III periods on a large coastal site such as Toumba *tou Skorou* to the northwest or perhaps further to Enkomi in the east.<sup>1422</sup> This type of organization could have easily evolved to meet local needs, and gradually expanded to accommodate a copper export trade with the copper producing communities either acting autonomously or under the direction of a central authority. The lack of copper in the slag may indicate that copper matte was produced at the site and then transported elsewhere to be further refined.<sup>1423</sup> The excavators estimate from the amount of slag recovered at Politiko *Phorades* that about 300 kg of copper, or enough copper for approximately ten oxhide ingots, could have been produced from this smelting operation.<sup>1424</sup> The partially refined matte produced at Politiko *Phorades* were likely processed at some regional or urban center like Atheniou, Enkomi, or Kition.<sup>1425</sup> To produce a large copper cargo, such as the Uluburun ship's copper cargo or the copper amounts cited by the King of Alashia in the Amarna letters, would have required dozens of smelting operations the size of the Politiko *Phorades* site. It seems

---

<sup>1420</sup> Kassianidou 1999, 95.

<sup>1421</sup> Keswani and Knapp 2003, 215, 217; Given et al. 1999, 30, 35.

<sup>1422</sup> Knapp et al. 1999, 144; Keswani and Knapp 2003, 214-5.

<sup>1423</sup> Kassianidou 1999, 95.

<sup>1424</sup> Knapp et al. 2002, 320.

<sup>1425</sup> Muhly 1989, 302.

likely that such smelting operations continued in the 14th and 13th centuries B.C., which may have been supplemented by larger, more centralized operations as well.

## 2) Apliki Karamallos

Apliki *Karamallos* was a Late Bronze Age settlement dating to the 13th century and early 12th century B.C. (LC IIC-LC IIIA), discovered during mining operations at the Apliki mine in northwest Cyprus; it was the first settlement of this period found in the area.<sup>1426</sup> Short salvage excavations were conducted during 1938-1939, after which the site was destroyed by mining activity.<sup>1427</sup> The site may have originally covered the entire plateau it was situated on; it was located on a ridge near the ore deposits, where the buildings were constructed on terraces cut into the bedrock.<sup>1428</sup> Four buildings, identified as residences based on the finds, were excavated on the site; these contained pottery (both tableware and storage vessels), querns and other domestic objects and small finds dating between the LC IIB and the beginning of the LC IIIA periods to the LC III B period (late 14th to late 13th centuries B.C.).<sup>1429</sup> Large amounts of metallurgical debris were also found in the dwellings, including slag and ash, a crucible or furnace lining fragment, and twelve exceptionally large tuyeres and tuyere fragments of several types (straight, bent or 'elbow', and 'D-shaped' tuyeres), probably intended for primary smelting operations.<sup>1430</sup> Many of the slag pieces consisted of large blocks, clearly the result of slag tapping, as well as 'ropy' slag, indicating that a tap hole was left open during the smelting operation.<sup>1431</sup> A large pile

<sup>1426</sup> Du Plat Taylor 1952, 133; Muhly 1989, 306.

<sup>1427</sup> Du Plat Taylor 1952, 133, 144, 150.

<sup>1428</sup> Du Plat Taylor 1952, 133, 138, 150.

<sup>1429</sup> Du Plat Taylor 1952, 142, 144.

<sup>1430</sup> Du Plat Taylor 1952, 138, 140, 148, 150, 152-3, 164, Pl. XXVIII; Muhly 1989, 307-8; 1991, 183.

<sup>1431</sup> Muhly 1989, 306-9; Merkel 1983, 174.

of this type of slag ('Phoenician' or 'red' slag) was located at the base of the hill near the Bronze-Age settlement; it was initially thought to be Roman in date, but Muhly points out that no surviving Roman finds were associated with the slag, and suggests it was the result of Bronze Age and not later industrial activity.<sup>1432</sup> Ancient mining galleries on the site may have also been associated with Bronze-Age mining activity.<sup>1433</sup> Muhly identifies the site as a Late Bronze-Age "mining and smelting site" and "miner's village."<sup>1434</sup> No furnaces were identified in the excavated areas, however, despite the large amounts of metallurgical debris.<sup>1435</sup>

If this identification is correct, then it is some of the best evidence in this period on Cyprus for a centralized labor organization in the actual mining areas, as opposed to central collection points for copper smelted in the surrounding area. The fact that the inhabitants of Apliki lived at the copper deposits show that an entire settlement was likely involved in specialized mining and copper production; this suggests a higher degree of organization than small smelting operations such as those discovered at Politiko *Phorades* and Ayia Varvara *Almyras*, which could have been run by small numbers of workmen a few days at a time, probably when they were not required for agricultural work. Whether this work was conducted by an autonomous village or under the direction of a larger center such as Toumba *tou Skorou*, is unclear, although the latter seems more likely for the LC IIC-III A period, when several wealthy centers flourished.<sup>1436</sup>

<sup>1432</sup> Muhly 1989, 307, 309; Du Plat Taylor 1952, 153.

<sup>1433</sup> Muhly 1989, 306, 309; Du Plat Taylor 1952, 150.

<sup>1434</sup> Muhly 1989, 306, 309.

<sup>1435</sup> Du Plat Taylor 1952, 152.

<sup>1436</sup> Negbi 1986, 111.

Keswani and Knapp propose the existence in Late Bronze Age Cyprus of “agricultural support villages” established by a central authority to supply small-scale mining operations in copper-rich areas with food and other goods.<sup>1437</sup> The Late Cypriot sites of Aredhiou *Vouppes*, discovered by the Sydney Cyprus Survey Project (SCSP), and Analiondas *Palioklichia*, surveyed by Webb and Frankel, both apparently villages of significant size, have been proposed as examples of this type of site due to their proximity to copper ore deposits and the large number of pithos sherds found in surface collections.<sup>1438</sup> Copper production on Cyprus in the Bronze Age may have been characterized by many small seasonal mining and smelting operations in copper-rich areas, whose products were sent to central collection points as tribute, perhaps supplemented by occasional large-scale mining parties consisting of unskilled laborers or soldiers accompanied by a few professional miners and prospectors and led by officials of a central authority.<sup>1439</sup> The hiring or impressments of local populations was another possible source of labor; the use of indigenous labor by Egyptian-run smelting operations at Timna may account for the presence of ‘Midianite’ pottery and artifacts from northwestern Arabia in the smelting camps at Timna.<sup>1440</sup>

It appears that a locally developed, small-scale metallurgical industry was gradually co-opted by elites on Cyprus in order to obtain copper to exchange for foreign goods,

<sup>1437</sup> Keswani and Knapp 2003, 217.

<sup>1438</sup> Webb and Frankel 1994, 5-7, 17-8, 20; Knapp 1997, 53; 2003, 569-71; Given and Knapp 2003, 179-81, 266-70.

<sup>1439</sup> Shaw 1998, 243-4, 246-7. See also Pritchard 1950, 229-230, for a Twelfth Dynasty (c. 1840-1790 B.C.) text referring to an Egyptian mining expedition in Egypt’s Eastern Desert. An inscribed stela found in the desert southeast of Aswan records an expedition by an official named Hor to collect “copper of the Land of Nubia”; the stela dates to the reign of Senwoset I (Twelfth Dynasty) (Lucas and Harris 1999, 209). Large workings and mining camps dating to the Old and Middle Kingdom, as well as Egyptian inscriptions, are known from Sinai (Petrie 1906, 51-2; Shaw 1998, 247-8, 253; Lucas and Harris 1999, 202-3; Mumford 2006, 52-60).

<sup>1440</sup> Rothenberg 1988, 8.

which began to appear in some quantity by the mid-second millennium B.C.<sup>1441</sup> The smelting site of Politiko *Phorades* also dates to this period. The slag and furnace remains from the site suggest a well-developed smelting technology by this time, although the size of the site and circumstantial evidence for seasonal use suggest that copper production may not have been strictly controlled. A tribute system, where settlements were required to supply a specific amount of copper annually, seems the most likely model for production on Cyprus for most of the Bronze Age. Funerary evidence and the presence of luxury imports on the island indicate an elite class had developed by the Late Bronze Age, but there is little evidence for strict control over the mining districts. The incised marks on the Uluburun ingots may also support this conclusion; the wide variety of signs seems more consistent with origins in many different small sites in the mining districts rather than origins in one or a few major production centers. It may be significant that far fewer different signs are found on the Uluburun tin ingots, which would necessarily be imported over longer distances before being loaded on the ship than the Cypriot copper oxhide ingots; if the signs were made by Cypriot merchants, they would have had fewer channels to procure tin imported over long distances than copper which could be obtained from the many deposits on their native island.<sup>1442</sup> Of Raber's three models for the organization of copper production in premodern world, the third, a "transitional, mobilized, local industry," seems to best fit the archaeological evidence from Late Bronze Age Cyprus.<sup>1443</sup> In this model, traditional local industries were 'mobilized' by a central

<sup>1441</sup> Karageorghis 2002, 11-25.

<sup>1442</sup> The greater variety in signs on the copper ingots could also be due to the way in which they were transported. The Uluburun copper ingots may have been assembled in a Levantine port many small shipments by independent Cypriot merchants over a period of time; the copper could have been stored in a warehouse until the entire ship's cargo was assembled). The tin ingots may have also been imported by Cypriot merchants, but brought in in fewer, larger shipments over a longer distance (C. Pulak, personal communication).

<sup>1443</sup> Raber 1987, 301-2.

authority by “either... direct interference through the state, indirect interference through tribute or levy, or indirect interference through a market system.”<sup>1444</sup> The Cypriot evidence seems to show a great degree of exploitation of copper resources by elites, who nonetheless lack the ability to strictly control the population in the mining areas or develop the degree of control seen, for example, in the mining and quarrying expeditions conducted by the Egyptians in the Eastern Desert and Sinai, or later Roman exploitation of copper and other metals in Spain.<sup>1445</sup>

The 13th-century B.C. settlement evidence from Cyprus strongly suggests an increase in wealth and centralized control, probably based on the intensification of the copper trade. The rise and relatively short lifespans of Kalavassos *Ayios Dhimitrios* and Maroni *Vournes* (as well as other more poorly documented centers) are probably due to such an intensification and perhaps to competition between rival centers, as Keswani and Knapp have recently suggested;<sup>1446</sup> it has been noted that there is no clear evidence for a single central authority on the island (i.e., no ‘palaces’), and although seal use and the recovery of Cypro-Minoan texts indicate some use of script by elites, there is no evidence for the developed central bureaucracies seen in Near Eastern and Aegean palaces.<sup>1447</sup> The development of two or more rival centers, each with its own copper-procuring network and each competing for portions of the copper trade, could help explain the increase and later collapses of several Late Cypriot centers on the island. However, lead-isotope evidence from copper ingot finds dating to after c. 1250 B.C. seem to indicate an origin from the Apliki ore body, suggesting that one city in the northwest (Toumba *tou Skorou*?) was dominating the production

<sup>1444</sup> Raber 1987, 301-2.

<sup>1445</sup> Shaw 1998; Forbes 1966:7, 158-62; 1964:8, 101.

<sup>1446</sup> Keswani and Knapp 2003, 220.

<sup>1447</sup> Muhly 1985b, 42-4; Smith 2002, 10-25.



and trade of these objects by the later 13th century B.C.<sup>1448</sup> The evidence for centralized control and production of copper on Cyprus remains ambiguous.

---

<sup>1448</sup> Gale 1999, 116; 2001; Stos-Gale et al. 1997. The identification of specific ore bodies using lead-isotope analysis is not universally accepted, however (see Knapp 2000, 37-48, and rebuttal in Gale 2001, 113-30).

## CHAPTER IX

CONCLUSION. THE ORGANIZATION AND EVOLUTION OF THE  
COPPER TRADE IN THE BRONZE-AGE MEDITERRANEAN

Based on current evidence, the use of oxhide ingots can be divided into three phases. The earliest evidence comes from at least seven sites on Crete, the earliest dating to the LM IB (c. 1500-1450 B.C.) period.<sup>1449</sup> Before this period, Aegean metallurgy seems to have relied on a combination of local sources, mainly in Greece (Laurion) and the Cyclades, and smaller amounts of metal transported from further afield. In this respect they are similar to other civilizations, particularly Egypt and Mesopotamia, whose copper came from a variety of sources throughout the Bronze Age: the Mesopotamians seem to have imported copper from Iran, Anatolia, Oman, and on occasion Cyprus, while the Egyptians exploited local copper sources and intermittently, copper deposits in the Sinai, as well as importing copper from Syria, Cyprus, and perhaps other regions.<sup>1450</sup> The metal industries of Cyprus and Anatolia, by contrast, were fueled primarily by local copper sources, though both regions imported tin.

The use of oxhide ingots seems to be closely connected with the Minoan palaces; they are found in metallurgical installations and in the remains of storerooms at Hagia Triadha, Zakros, and Tylissos, and in bronze workshops at Gournia, Palaikastro,

---

<sup>1449</sup> Muhly et al. 1988, 283-4; Mangou and Ioannou 2000.

<sup>1450</sup> Moorey 1994, 243-7; Rothenberg 1972, 229-33; Lucas and Harris 1999, 208-12; Gale and Stos-Gale 1999, 272.

Mochlos, and Poros-Katsambas.<sup>1451</sup> However, the origin of the oxhide ingot shape and the source of much of the copper from which oxhide ingots were made is unknown. The lead-isotope measurements from many early oxhide ingots found in Minoan palaces are not consistent with any measured ore source.<sup>1452</sup> An origin in central Asia, Anatolia, or the Caucasus are the most likely possibilities. Stech and Piggott as well as Muhly have suggested a tin trade route from the Black Sea, either via Mesopotamia (Stech and Piggott) or across the Black Sea from Colchis (Muhly), and then to Troy, which is unusually rich in tin bronze at an early date, and from Troy to the Aegean in order to explain the early tin sources of the Minoans.<sup>1453</sup> If such a tin route existed, perhaps copper in the form of oxhide ingots were traded along it as well; it could be introduced at any leg of the journey. However, a source of Trojan tin in Anatolia and Minoan tin from central Asia via the Levant seems much more likely, particularly based on texts from Mari mentioning the export of tin to ‘Caphtor.’<sup>1454</sup> The oxhide ingot shape probably evolved either in Anatolia or central Asia as a response to foreign markets for copper and tin. Lead isotope evidence indicates that a portion of copper and other metals used in the Early and Middle Bronze Age Aegean came from Anatolia; perhaps increased demand from Minoan palaces and other regions (likely in conjunction with demand elsewhere) stimulated an export trade in copper from the as-yet unidentified sources of the Hagia Triadha and Zakros ingots during the 16th and 15th century B.C.<sup>1455</sup> These seem to have been transported by sea on at least some occasions, as the Kyme ingots and ‘pillow’ ingots recovered from the Bay of Antalya show. The volume of the copper trade in this early period is difficult to ascertain, but

---

<sup>1451</sup> Muhly et al. 1988, 282-5; Hakulin 2004, 54-5.

<sup>1452</sup> Gale 1999, 110.

<sup>1453</sup> Muhly 1999, 18-9; Stech and Piggott 1986, 54-7.

<sup>1454</sup> Malamat 1971, 34; Strange 1980, 90.

<sup>1455</sup> Gale 1991, 224-6.

judging from the sophisticated Minoan bronze work of the period it was probably fairly large (although not in comparison to the demand in Egypt and Mesopotamia). By the 15th century B.C., the oxhide ingot was already recognized as an international standard ingot shape. Wherever the first copper oxhide ingots came from, it was not the only source of copper for the Minoans; lead isotope ratios of the early Minoan ingots indicate they were made from a variety of unidentified sources.<sup>1456</sup>

The ‘pillow’ ingot form (Buchholz/Bass Type 1) was the only oxhide ingot form in use in this early period. The shapes of oxhide ingots had changed and multiplied by the late 14th century B.C.; the Uluburun ship carried at least three major types of oxhide ingots, but only five were of the older Type 1 ingots.<sup>1457</sup> Bass (1991, 72) and others have pointed out the fact that the oxhide ingot shape cannot be used as a reliable chronological indicator, although the Type 1 ingots were in use first and were more prevalent in the earlier Bronze Age (15th century B.C.), while Types 2 and 3 were more common in the 14th and 13th centuries B.C., the period in which Cyprus became a major copper supplier for much of the Mediterranean and Near East.<sup>1458</sup> Cypriot copper began to be exported into the Aegean by the mid-17th century B.C., as shown by copper scrap from Akrotiri with a lead isotope signature consistent with a Cypriot source.<sup>1459</sup> Around this time references to copper from ‘Alashia’ begin to appear in Near Eastern and Hittite texts, indicating that the island’s copper wealth was

---

<sup>1456</sup> Evely 2000, 335.

<sup>1457</sup> Pulak 1987, 30-2. See also Yalçın et al. 2005, 561-8 for some examples of variation in copper oxhide ingot shape.

<sup>1458</sup> Bass 1991, 72.

<sup>1459</sup> Minoan copper importation seems to have involved the exploitation of a number of smaller sources of copper into the LM IB and perhaps later. The lead isotope results from copper ingot fragments and copper and bronze scrap from the Artisans’ Quarter at Mochlos reveal that the copper ingot fragments are almost exclusively from Cyprus while the scrap metal comes from a variety of sources, including Laurion, the Taurus Mountains of Anatolia, and Cyprus (Soles and Stos-Gale 2004, 54-9). These results may be due to the operation of a trade in scrap copper and bronze which occurred alongside and was perhaps largely replaced for a time by the trade in oxhide ingots.

becoming known far from its source. At some point the Cypriots either copied or adapted the oxhide ingot shape as a form for locally produced ingots. The increasing importance of Cyprus in this trade becomes apparent in the 14th and 13th centuries B.C., judging from the combination of oxhide ingot and Cypriot pottery finds in Crete, particularly at Kommos.<sup>1460</sup> Copper ingot fragments from the LM IB Artisans' Quarter at Mochlos are made from Cypriot copper, including a piece Soles and Stos-Gale identify as the corner of a Type 1 oxhide ingot.<sup>1461</sup> If this identification is correct, then this is perhaps the earliest oxhide ingot from Cyprus yet identified. Its 'pillow' ingot shape suggests that the Type 1 oxhide ingot shape was copied directly by Cypriot metallurgists.<sup>1462</sup> By the 14th century B.C., however, this shape has been almost entirely abandoned, judging from the copper cargo from Uluburun; only five of the 354 oxhide ingots are of this type, while the rest are Type 2 and 3 ingots.<sup>1463</sup> Significantly, all of these ingots are also made of Cypriot copper.<sup>1464</sup> It appears that the change to more elongated handles and the pinched 'waist' seen on the majority of known Late Bronze Age ingots occurred sometime during the later 15th and 14th century B.C. Perhaps this modification to the ingot form was a Cypriot invention, either to facilitate their transport on land or as a 'trademark.' Such a change may have been desirable if copper ingots were being cast near the ore sources and then

<sup>1460</sup> Rutter 1999, 140, 142; Vagnetti and LoSchiavo 1989; Hirschfield 2001; Shaw 2004.

<sup>1461</sup> Soles and Stos-Gale 2004, 54, Fig. 19.

<sup>1462</sup> This piece could also be from a Buchholz/Bass Type 3 ingot, however; similar ingot 'corners' were found in the Oberwilfligen hoard in Bavaria and have been reconstructed in this way (Primas and Pernicka 1998, 28, 30-33, 42; 2005, 389; cf. Bass 1967, 53). This hoard is dated to the 14th or early 13th century B.C. (Primas and Pernicka 1998, 27). The undated Kyme ingots, which are also Type 1, have lead isotope ratios consistent with Cypriot ore sources; perhaps these could also date to soon after the introduction of the oxhide ingot shape to Cyprus (Gale 1999, 117).

<sup>1463</sup> There is a significant amount of variation in the shapes of the four-handled oxhide ingots from Uluburun for which the Buchholz/Bass oxhide ingot typology does not fully encompass. A more detailed ingot typology is being developed by C. Pulak. It is unclear whether the variation in shapes is accidental or the result of regional styles of manufacture, the preferences of individual smelters, or some other potentially discernible pattern.

<sup>1464</sup> Gale 1999, 118.

transported overland to coastal towns where they were consumed or exported. Some smelting and refining activity may have occurred in coastal towns in this period (particularly at the 'Fortress' at Enkomi) and perhaps Hala Sultan Tekke, but it is unlikely that this was the dominant method of ingot production.<sup>1465</sup> The reason or reasons for the wide distribution of the lead isotope ratios of these ingots within the Cypriot field could mean that they were smelted from a variety of deposits, or an unrecorded one.<sup>1466</sup> The variation in oxhide ingot shapes and in the marks incised on them imply that a range of production methods were in use. There is clearly a significant increase in copper production for export during this period; Cyprus was becoming the dominant source of copper for much of the eastern Mediterranean by the end of the 14th century B.C.<sup>1467</sup> This transformation of the island's role in the Mediterranean can be considered the second stage in the evolution of the oxhide ingot trade.

Syro-Palestinian city-states, particularly Ugarit, seem to play a major role in this second stage, both as consumers and as distributors of copper. Textual evidence shows that Ugarit was forced to import copper in the Late Bronze Age. Since 'Alashia,' only a short distance by sea, was already becoming famous as a copper source, the rulers of Ugarit and other Levantine cities were likely keen to cultivate extensive trade relationships with the island. The introverted nature of indigenous Cypriot society in the Early and Middle Cypriot periods suggests that Near Eastern merchants made the first overtures for large-scale trade, and offered exotic foreign 'prestige goods' in change for copper and perhaps other raw materials. This development likely had the

---

<sup>1465</sup> Knapp 1990, 137.

<sup>1466</sup> Gale 1999, 118.

<sup>1467</sup> Knapp 1990, 137.

effect of increasing social differentiation and economic production of export goods, very likely for the reasons proposed by Keswani.<sup>1468</sup> By the middle of the second millennium, the towns of Enkomi and Hala Sultan Tekke and possibly other towns such as Toumba *tou Skorou* were involved in foreign trade at a significant scale, probably revolving around the procurement of prestige goods by elites in exchange for large amounts of raw materials available on the island such as copper and perhaps timber and a few manufactured goods such as pottery.<sup>1469</sup> Finds on Cyprus from this period include imports of Minoan, Near Eastern, and Egyptian material; Cypriot pottery was also exported to Egypt in increasing amounts.<sup>1470</sup> These materials could be obtained through Near Eastern intermediaries or by independent Cypriot trading or gift-exchange ventures. One such expedition was sent to Thutmosis III in c. 1470 B.C. by the King of 'Isy,' a locality often identified with Cyprus; the pharaoh received copper, lead, horses, timber, ivory, and lapis lazuli.<sup>1471</sup> It may be significant that most of the King of Isy's gifts are raw materials which cannot be obtained on Cyprus or in the neighboring Aegean.

About 150 years later, the King of Alashiya's correspondence with the pharaoh Akhenaton runs along similar lines; he sends copper and timber for ships, along with smaller gifts of horses and ivory. In return, he asks for silver, an exotic foreign prestige good in exchange for a 'strategic' raw material.<sup>1472</sup> He is the only ruler in the Amarna tablets to send bulk cargoes of raw materials as his 'gift' to the pharaoh; this suggests a relative lack of access to precious metals, stones, and other exotic materials

<sup>1468</sup> Keswani 2005, 393-4.

<sup>1469</sup> Karageorghis 2002, 11, 13; Knapp 1997, 47.

<sup>1470</sup> Karageorghis 2002, 11-7; Muhly 1985b, 29-31.

<sup>1471</sup> Karageorghis 2002, 15; Strange 1980. See also n. 95.

<sup>1472</sup> Moran 1992, 110.

that usually comprise the gifts exchanged in Amarna-period diplomatic correspondence.

The Cypriot cargo of the Uluburun ship perhaps shows that Cypriot merchants were also in a similarly ambiguous position in their economic relations with foreigners. Kassianidou<sup>1473</sup> has recently argued that a Cypriot origin for the Uluburun ship is “equally probable” as a Syro-Palestinian one, an origin which has been considered more likely by Bass<sup>1474</sup> and Pulak.<sup>1475</sup> Though Kassianidou is of course correct in assigning the Cypriots a major role in international trade in this period (the Cypriot copper is the largest and heaviest category of object tonnage-wise in the cargo), the exotic manufactured goods on the vessel, as well as the bulk cargoes of glass ingots and terebinth resin have origins in the Levant, Egypt, or elsewhere in the Near East.<sup>1476</sup> The goods that can be unambiguously identified as Cypriot on the vessel are valuable raw materials—copper—supplemented by a few pithoi of Cypriot pottery. S. Sherratt counts the latter as a “sub-elite” good, never intended to be part of a royal gift exchange and probably brought aboard by a merchant in the service of the ruler or elite who dispatched the ship.<sup>1477</sup> Such smaller secondary cargoes could have been traded by lower-level officials or palace functionaries attached to the more official trade. Some of these cargoes may have even been assembled by smaller, independent merchants with looser connections to palace elites; such semi-independent merchants seem to be a feature of Bronze Age trade of the 14th century B.C. and later. A 13th-

<sup>1473</sup> Kassianidou 2003, 115.

<sup>1474</sup> Bass 1991, 75.

<sup>1475</sup> Pulak 1997, 252.

<sup>1476</sup> Pulak 1997, 252; 1998, 204-7. These glass ingots may have been manufactured in Egypt or Mesopotamia, while the terebinth resin cargo is from Syria (Pulak 2001, 25-8, 33-7).

<sup>1477</sup> Sherratt 1994, 64; 2000, 83. Some categories of objects from the ship, such as sets of weights and stone anchors, correspond to types found both in the Levant and Cyprus, however (Pulak 1997, 252). Used lamps on board the ship with charred nozzles are Syro-Palestinian in origin (Pulak 1997, 252).



century B.C. text from Ugarit mentions a lost copper cargo from a ship (KTU 4.394), and lists owners of portions of the cargo (“20 for the people of Umd/ 10 for Kutilana”) as though they are investors.<sup>1478</sup>

The presence of Cypriot export pottery on sites in the Levant and Egypt and, to a lesser extent the Aegean, suggests that such ‘sub-elite’ trade occurred at a considerable scale.<sup>1479</sup> The Late Bronze Age escalation of Cypriot copper export may have been initiated by Syro-Canaanite merchants and rulers, but it could have also offered Cypriots lucrative opportunities, either to arrange the production and transport of copper and other goods desired by their Levantine trading partners or by entering their service. Cypriot merchants likely began to take a more independent role by the Late Bronze Age. In one of the Amarna tablets (EA 39), the King of Alashia requests a safe-conduct for men who are his “merchants.”<sup>1480</sup> In another letter, he requests the return of the possessions of an Alashian who died in Egypt; this man was most likely “a merchant or trading agent similar... to the Alashian traders at Ugarit.”<sup>1481</sup> Two more letters from Alashia contain complaints about the taxing of the cargoes of Alashian ships by Egyptian officials.<sup>1482</sup> The abundant Mycenaean pottery as well as the Cypriot pottery at Amarna may have been transported to the site by Cypriot merchants, who recognized a lucrative foreign market for Mycenaean goods.<sup>1483</sup> Some tentative documentary evidence exists in Linear B texts for the presence of Cypriots at

<sup>1478</sup> Hoftijzer and Van Soldt 1998, 339.

<sup>1479</sup> Muhly 1985b, 23-30; Wachsmann 1987, 116.

<sup>1480</sup> EA 39: 14-20.

<sup>1481</sup> EA 35: 30-4; Wachsmann 1987, 116.

<sup>1482</sup> EA 39: 17-20; EA 40:24-6; Wachsmann 1987, 116.

<sup>1483</sup> Wachsmann 1987, 115.

Pylos and Knossos.<sup>1484</sup> The only solid archaeological evidence for a Cypriot presence in Egypt is a Cypriot-style stone anchor made of local Egyptian stone found in the Temple of Amun at Karnak; this object must have been made by a Cypriot stonemason or sailor in Egypt, who perhaps left it in the temple as a dedication.<sup>1485</sup>

Similar evidence for the presence of Cypriots occurs at Ugarit. Numerous references to individuals identified as ‘Alashians’ occur in Ugaritic archives, and texts in Cypro-Minoan have been found on the site, indicating the presence of literate Cypriots, perhaps merchants or officials (see Chapter II).<sup>1486</sup> One text pertains to the metals trade, mentioning a ship from Alashia with various copper and bronze goods on board; this has been compared to the Cape Gelidonya ship and described as a private merchant vessel.<sup>1487</sup> Such an identification of the Cape Gelidonya ship as an independent merchant vessel is likely, but an identity as a royal cargo, albeit a less wealthy one than the Uluburun ship, is possible; the elites who supervised the production at Kition’s Temple 1 seemed to have no qualms about dealing with large amounts of scrap metal for profit.<sup>1488</sup>

The incised marks on the copper and tin ingots from Uluburun and other sites strongly suggest a Cypriot involvement in the procurement and assembling of the metal cargo, if Kassianidou’s application of Hirschfield’s theory on the use of these marks being a distinctly Cypriot practice is correct.<sup>1489</sup> The marks on the tin ingots are particularly

<sup>1484</sup> Four references in Linear B texts mention goods received from *ku-pi-ri-jo*, proposed by Chadwick (1976, 158) to refer to traders “from Cyprus.” Another text mentions “120 liters of cyperus seed from Cyprus” or “of the Cyprian variety” (Wachsmann 1987, 117).

<sup>1485</sup> Wachsmann 1987, 116; 1998, 281, Fig. 12.44..

<sup>1486</sup> Muhly 1985b, 36; Wachsmann 1987, 116-7.

<sup>1487</sup> Hoftijzer and Van Soldt 1998, 339; Linder 1972, 163-4; Maddin et al. 1977, 361-2; Bass 1991, 73.

<sup>1488</sup> Karageorghis and Kassianidou 1999, 183-6; Bass 1991, 73.

<sup>1489</sup> Kassianidou 2003, 115-7.

suggestive; perhaps a Cypriot merchant in a Levantine port assembled these as well as the copper ingots. This does not necessarily mean that a Cypriot was aboard the ship, but Cypriot merchants could have arranged the procurement of the metal cargo. It may be significant that incised marks appear on ingots from Hagia Triadha and a recently discovered ingot from a LM IB context at Mochlos, perhaps the earliest known oxhide ingots in the Aegean.<sup>1490</sup>

During this period, the Mycenaeans seem to have played some role as well, perhaps primarily as supporting personnel (mercenaries, porters, etc.), producers of trade goods such as pottery, and consumers rather than exporters. Imported luxury items occur in Linear B texts, including spices, ivory, blue glass paste, bronze, purple dye, exotic woods, alum, and terebinth resin; some of these commodities are identified by Semitic or Anatolian terms, indicating trade connections with these regions.<sup>1491</sup>

Various personal effects on the Uluburun ship suggest the presence of at least two high-status Mycenaeans on board, perhaps involved in the importation of foreign goods to the Aegean. Based on the preponderance of Syrian utilitarian goods on board, the ship is probably Near Eastern in origin, but could have been chartered to travel to an Aegean port.<sup>1492</sup> Pulak bases the argument for the presence of Mycenaean elites on the Uluburun ship on several factors. A large number of Mycenaean personal objects, many of an elite nature, are found on the vessel; these include tablewares, weapons (swords, spears, daggers), knives, razors, chisels, glass relief beads, beads of faience, quartz, and amber, and lentoid seals.<sup>1493</sup> Some of these items seem to occur in pairs or in sets, as is the case with the tableware, and many are not usually found outside of the

<sup>1490</sup> Buchholz 1959, 32-4; Evely 2000, 343-5; Whitley 2005, 102-3.

<sup>1491</sup> Wachsmann 1998, 154.

<sup>1492</sup> Pulak 1998, 216, 218-9; 2005, 306-9.

<sup>1493</sup> Pulak 2005, 296-306.

Aegean.<sup>1494</sup> Several other items of probable Balkan origin suggest a third foreigner on board, perhaps associated with the Aegeans; Pulak suggests that a Balkan mercenary was on board.<sup>1495</sup> Only one of the 150 weights found on the shipwreck is of probable Aegean origin, leading Pulak to believe that these individuals were envoys on a gift-exchanging voyage rather than high-status merchants.<sup>1496</sup> References in Linear B texts to high-ranking officials known as *e-qe-ta*, or ‘followers [of the king]’, appear in some cases to have had duties similar to ambassadors or governors, and may have undertaken such diplomatic missions to foreign courts.<sup>1497</sup> Two references in letters of Hattusili III mention envoys from Ahhiyawa (usually identified as a Mycenaean state) who were derelict in their gift-giving obligations; these texts indicate that Mycenaeans were at least sporadically involved in foreign diplomacy at the palace level, though not necessarily at the level of the other ‘great powers’ of the period.<sup>1498</sup>

Archaeological evidence of Mycenaean influence or colonization at the peripheries of the Aegean are clearly seen on the islands of Ialysos and Rhodes, and on the Anatolian mainland at Miletus and Müskebi, while signs of more indirect influence are apparent on Cyprus and further afield, including central Europe, where Aegean weight systems may have been used in the amber trade.<sup>1499</sup> The archaeological evidence of Mycenaean activities abroad is consistent with Hittite texts describing foreign, perhaps Mycenaean, raids and depredations on the Anatolian mainland and Cyprus in the same period.<sup>1500</sup> Wachsmann sees references to Ahhiyawan raids and naval activity in Late

<sup>1494</sup> Pulak 2005, 296-306. See Bachhuber 2006 for a critique of Pulak’s arguments and a discussion of the context and implications of the Aegean objects on the Uluburun ship.

<sup>1495</sup> Pulak 2005, 296, 308.

<sup>1496</sup> Pulak 2000b, 247-66; 2005, 308-9.

<sup>1497</sup> Bachhuber 2003, 138-41; Pulak 2005, 308-9.

<sup>1498</sup> Pulak 2005, 309; Bachhuber 2006, 354-7.

<sup>1499</sup> Ruiz-Gálvez 2000, 267-75.

<sup>1500</sup> Güterbock 1997b, 205-10; Singer 1983.

Bronze Age texts as consistent with pirates and mercenaries rather than traders.<sup>1501</sup> Mycenaean ship depictions on pottery are consistent with this interpretation; many clearly represent oared ships which could be packed with raiders rather than slower, roomier merchant ships.<sup>1502</sup> Despite large amounts of Mycenaean pottery outside of the Aegean, little evidence has surfaced to indicate that Mycenaean merchants were exporting the material themselves. The relative lack of other Aegean goods in the Levant and Egypt in this period indicates that they were more likely integrated into a system of international trade already established and dominated by Semitic and Cypriot merchants.<sup>1503</sup> The distribution of Minoan, Mycenaean, and Cypriot pottery and ‘Canaanite’ jars throughout most of the eastern and parts of the central Mediterranean testifies to the extensive trade links developed, perhaps in large part due to exports, including copper, that have not always survived in the archaeological record.<sup>1504</sup> The Knossos and Pylos tablets show that the Mycenaean were major consumers of metal, producing large numbers of finished objects, while the distribution of Mycenaean pottery finds show that they produced large amounts of pottery for export. Incised marks on commonly exported Mycenaean pottery may be evidence of Cypriot rather than Mycenaean control of the trade and transport of these items, in a trade primarily oriented towards the Near East for most of the Late Bronze Age.<sup>1505</sup>

<sup>1501</sup> Wachsmann 1998, 128-30, 154-5.

<sup>1502</sup> Wachsmann 1998, 130-8.

<sup>1503</sup> Pulak 2005, 309.

<sup>1504</sup> Bass 1967, 165-6; Muhly 1985b, 22-30; Ridgway 1996, 117-9; Vagnetti 1996, 109-16.

<sup>1505</sup> Muhly (1985b, 22-4, 29-30) among others has noted the large amounts of exported Cypriot pottery in the Levant and Egypt, particularly in comparison to Anatolia and the Aegean, and its almost ubiquitous association with Mycenaean pottery on Levantine sites. See Hirschfield (1996, 291-3; 2002) for a discussion of the probable Cypriot connection to incised marks on pottery.

Even if Cypriots had no involvement with the Cypriot portion of the Uluburun cargo once it left the island, it shows a considerable degree of economic sophistication, in the size and relative uniformity of the copper cargo-- particularly the types of ingots and the quality and sources of the copper-- and in the wide variety of incised marks, which suggest that the ingots were received from many different localities on the island or through different intermediaries. Studies of the composition of oxhide ingots show that they are the products of a fairly sophisticated copper industry, a premise supported by the slag finds from Politiko *Phorades*, Apliki *Karamallos*, and other sites, which are the products of fairly efficient smelting processes.

The role of Cypriot craftsmen in the manufactured goods from the Uluburun cargo seems to be a subordinate one. A century later, one might expect Cypriot bronze stands in a cargo as rich as the Uluburun ship's, along with many other examples of distinctively Cypriot metalwork. This is a major difference between the archaeological evidence for Cypriot metallurgy in the 14th century B.C. and the evidence from a century or two later. A third major stage in the evolution of the oxhide ingot trade seems to have occurred in this period. Besides a larger number of metal finds, more elaborate and distinctly Cypriot bronzework is in evidence, including a bronze 'wall bracket' and portable hearth from Sinda, numbers of Cypriot stands, all of which seem to date from c. 1200 B.C. or later; the bronze sculptures of probable deities from Enkomi and other Late Cypriot sites are also significant examples.<sup>1506</sup> Indigenous production of finished bronzes seems to have increased dramatically, both in volume and sophistication, as a response to foreign influence and a desire by indigenous elites

<sup>1506</sup> Karageorghis 1973; Catling 1964, 192-211. Buchholz recently published a two-sided limestone mold from Sinda with open molds for several objects, including what may be a mold for a miniature oxhide ingot (length: 4.5 cm; width: 1.8 cm) (Buchholz 2003, 126-8, 130).

to assert their superior social status. The changes in Cypriot metallurgy are contemporary with an expansion in numbers of large settlements on the island, construction of elite structures using ashlar masonry, an increase in foreign imports such as Mycenaean pottery, the adoption of new types of foreign weapons and armor, and the most numerous finds of oxhide ingots and ingot fragments on land sites.<sup>1507</sup>

The large numbers of Cypriot metal objects in the central Mediterranean—including bronze stands, smithing tools, oxhide ingots, and small amounts of Cypriot pottery—indicate a significant and probably independent involvement by Cypriots in large-scale foreign trade in the area. The concentration of metal-related Cypriot goods in the central Mediterranean suggests an interest in new sources of metal to some scholars, especially tin, which could have been imported to Sardinia from the Iberian Peninsula<sup>1508</sup>; unfortunately, there is little evidence for what central Mediterranean people traded to the Cypriots. Although the duration and volume of this trade are poorly understood, a significant metals trade between Cyprus and Sardinia after 1200 B.C. could have been a major reason for the continued prosperity of many important Cypriot sites into the next two centuries, long after important Cypriot trading partners such as Ugarit had been destroyed.<sup>1509</sup>

Major settlements in this period such as Enkomi, Kition, and Hala Sultan Tekke probably included areas where partially refined copper was brought to be purified and cast into oxhide ingots. Area III at Enkomi is the best example for what this kind of a facility might have looked like; Temple 1 at Kition is also a possible production

<sup>1507</sup> Karageorghis 2002, 92-9; Knapp 1990, 137; Steel 2004, 196. See also Appendix 2.

<sup>1508</sup> Ruiz-Gálvez 2003, 153-5; LoSchiavo 2003, 129-30; Fadda 2003, 138;

<sup>1509</sup> Knapp 1990, 137.

center. Unfortunately, the archaeological contexts of metallurgical workshops in urban sites tended to be destroyed or extensively modified by their users and other local inhabitants. Slag on these sites was dumped in refuse pits and wells, used as floor material or rubble fill for later structures. Furnaces were probably demolished after one use in order to retrieve the copper after one or a few uses, leaving only the bowl shaped depressions or pits found in various levels in the 'Fortress' at Enkomi and Temple 1 at Kition; some of these seem to have been filled in or recycled as refuse pits. Similarly, crucibles and tuyeres probably had a short lifespan. The molds used to cast copper ingots could have been most likely cut directly into the floors of these workshops (similar to rammed-earth copper tapping pits described by Agricola); they would probably also be obliterated fairly quickly.<sup>1510</sup> An oxhide-ingot production center under control of a central authority within a settlement may therefore go undetected.

Alternately, such centralized production as seen in the furnaces of Enkomi may have been the exception rather than the rule. The differences in the physical characteristics of copper ingots suggest that there were different regional traditions in copper ingot casting within Cyprus, or metallurgists and merchants had a practical preference for ingots of difference sizes in order to simplify ingot-breaking or weighing procedures. These were probably not produced only in large settlements at the height of production in the Late Bronze Age, although the reusable bun ingot molds used to make many ingots from Uluburun imply some standardization. Many Cypriot settlements near ore deposits may have initiated small, seasonal smelting operations to produce oxhide

---

<sup>1510</sup> Hoover 1950, 377-8. The metallurgical remains from the Arabah and Feinan regions seem to be so well-preserved in large part because they are found in arid, almost uninhabited regions (see Weisgerber 2003; Rothenberg and Glass 1992; Rothenberg 1988, 1.



ingots or, more likely, had such measures forced upon them in the form of annual taxes or tribute to regional centers.<sup>1511</sup> This type of production probably continued at some scale throughout the period of their manufacture. A relocation of the later stages of ingot production to large towns on the coast probably occurred to maximize economic control over the rate of production and over metallurgical specialists. The Late Cypriot site at Apliki seems to indicate that in at least one case an effort may have been made to relocate such centrally-controlled operations to the mining area itself.<sup>1512</sup> Slag remains from the LC IIC sites of Maroni *Vournes* and Atheniou suggest that small-scale metallurgical activity on these sites occurred before the main period of occupation. Small smelting sites probably covered the mining district by the Late Cypriot period. Some may have been visited seasonally over many years, as Politiko *Phorades* and Ayia Varvara *Almyras* on Cyprus and Chrysokamino on Crete seem to have been, but many more may have been used only once. This is likely a major factor in why Late Bronze Age smelting sites are so rarely identified.

Another lingering problem is the relationship between elite culture, foreign contacts, and copper production on Cyprus in the 13th and 12th centuries B.C. Did the intensification of production and increase of wealth and foreign contacts on the island occur by the dominance of a single center (Enkomi?) with a “King of Alashia?” Or was the island divided into rival centers, each with their own network of mines, agricultural settlements, and ports? The settlement, funerary, and architectural evidence from the LC IIC shows that elite groups whose wealth seems to have derived

<sup>1511</sup> Knapp 2003, 569.

<sup>1512</sup> Knapp 2003, 574. Keswani and Knapp (2003, 215) point out the “large and well-constructed” House A at Apliki, in which were found “substantial storage facilities,” and “elite prestige goods such as a gold earring, a Mycenaean granary style crater, an ivory cylinder and a steatite cylinder seal.” Keswani (1993, 77) suggests House A may have been a sort of elite residence for an administrator of the mining village (Keswani and Knapp 2003, 215).

primarily from copper wielded considerable power across the island.<sup>1513</sup> It is not clear whether these groups were in competition with each other, either regionally or even within communities; however, the lead-isotope data from artifacts of the period including oxhide ingots suggests a shift to copper production for export to the Apliki ore body, which in turn implies some kind of central authority over the copper production and export on the island or else a virtual monopoly on copper production by one of several independent regional groups on the island.<sup>1514</sup>

By 1200 B.C., the copper trade was likely connected with cult activity in several settlements on Cyprus, particularly Enkomi and Kition, and perhaps in the Levant at Ras Ibn Hani, Tel Nami, and several other sites as well.<sup>1515</sup> The use of copper in ritual contexts was not new, for example, in Hittite and Egyptian foundation deposits. But the close association of oxhide ingots with the proposed ‘Ingot God’ and ‘Ingot Goddess’ of Enkomi, in apparently ritual scenes including oxhide ingots on bronze stands, and in the evidence of metallurgical activity in sanctuaries or important administrative buildings provide strong evidence for a ritual role for copper among Cypriot elites. This appears to be a fairly late (LC IIC) development, during the height of Cyprus’ importance as an exporter of copper and other goods; it could be seen as an attempt by Cypriot elites to ensure the continued abundance of Cypriot copper production through religious means. Participation at lower levels of society may have occurred as well (for example at Alassa, where a miniature oxhide ingot was found in association with terracotta bulls in an apparent domestic shrine); it may be more accurate to see the promotion of Cypriot deities connected with copper production (if

<sup>1513</sup> Knapp 1990, 149.

<sup>1514</sup> Gale 1999; 2001.

<sup>1515</sup> Knapp 1986, 80; Negbi 1986, 114-7; Artzy 1995, 23; 2000.

it was in fact that explicit) as part of a state-sponsored religion rather than an exclusive religion of elites. The Temple of Hathor at Timna has perhaps the best archaeological evidence of such an elite or state-sponsored cult with close associations to mining and metallurgy.<sup>1516</sup>

Webb notes a wide variety of potentially religious iconography on seals and other elite objects in the period, and cites a reference in an Ugaritic tablet to “all of the gods of Alashiya” as evidence of the complexity of Cypriot religious practices.<sup>1517</sup> Cypriot copper was involved in the practices of Cypriot elites, but the roles it played and the beliefs connected to it probably varied from one site to the next. This is reflected in the temples at Enkomi and Kition; in the former, the oxhide ingot is used as a probable religious symbol in the form of the ‘Ingot God’ and miniature votive ingots. At Kition, metallurgy also has a close connection to religious activity, although no evidence of religious iconography explicitly associated with oxhide ingots has been found there.

The evidence for the variation in religious iconography and practices found in LC IIC elite contexts offers support to the idea that no single ruler or political entity exerted direct control over all of the major settlements on the island. Each region may have therefore pursued its own programs of copper production and trade. Other evidence from the 13th century B.C. may also indicate that a system of purely or primarily palace-based trade in metals, as exemplified by the Amarna texts and the Uluburun ship cargo, may have been changing as well. According to S. Sherratt, it is in the second half of the 13th century B.C. when large numbers of ‘Urnfield’ type bronzes of European styles begin to appear in the Mediterranean in large numbers; these include

---

<sup>1516</sup> Rothenberg 1988.

<sup>1517</sup> Webb 1999, 239, 276-81.

fibulae, pins, weapons and armor types, particularly Naue Type II swords, ‘Perschiera’ daggers, and one-piece cast bronze spears.<sup>1518</sup> This matches pottery finds in the central Mediterranean, which indicate increasingly important trade contacts with Sicily, southern Italy, the Aeolian Islands, and Sardinia.<sup>1519</sup> These were deposited in graves, votive deposits, and scrap or foundry hoards, often in “otherwise unremarkable graves and sanctuaries.”<sup>1520</sup> One of the earliest imports from the central Mediterranean (an Italian-style sword of the ‘Pertosa’ type) as well as the Balkans (a globe-headed pin, a stone scepter-mace, several spearheads, and a bronze weight) were found on the Uluburun shipwreck, and the find spots of many of these objects cluster around “long-distance maritime and isthmus routes,” indicating a close connection with maritime traffic<sup>1521</sup> Trade between the central and eastern Mediterranean, in which Cyprus likely played a prominent role, probably accounts for these objects, as well as the general increase in scrap metal finds on Bronze Age sites in the eastern Mediterranean dating to around 1200 B.C. Sherratt believes this is due to an “increase in the velocity of circulation of bronze scrap at an informal level in the eastern Mediterranean,” due to the establishment of new trade contacts in the central Mediterranean in this period by eastern Mediterranean non-elite traders who had largely bypassed the palace-controlled directional trade between eastern Mediterranean ports: “what we are seeing is the growth of alternative networks: the erosion of monopolistic control by entrepreneurial activity, uniting European ‘barbarians’ and eastern Mediterranean ‘free traders’ in a mobile commodity flow, which undermined and swept away the older system.”<sup>1522</sup>

<sup>1518</sup> Sherratt 2000, 84-5, 87.

<sup>1519</sup> Vagnetti 1996; Cline 1994b, 78-81; Ridgway 1996.

<sup>1520</sup> Sherratt 2000, 87.

<sup>1521</sup> Sherratt 2000, 85; Giardino 2000b, 100; Pulak 2001, 46-7; 2005, 296, 299.

<sup>1522</sup> Sherratt 2000, 87, 89.

One example of this process may be the 13th-century B.C. site of Tel Nami, located on the southern Levantine coast close to the major port of Tel Abu Hawam. According to the M. Artzy, the site's excavator, it may have been situated to bypass Tel Abu Hawam in maritime trade; similarly, the sites of Sinda, Pyla-Kokkinokremos, and Maa-Palaekastro on Cyprus, which have been proposed as 'refugee' settlements by Karageorghis and Demas (1984; 1985; 1988), also straddled important trade routes.<sup>1523</sup> All of these sites show substantial wealth in the form of metal scrap hoards of bronze and copper, silver and gold (at Maa-Palaekastro), rich metal grave goods (Tel Nami), as well as a concern with defense in the form of substantial fortifications.<sup>1524</sup> These sites are also contemporaneous with the majority of oxhide ingots finds from land sites and the furthest extent of their discovery in datable archaeological contexts; their use continues into the 12th and 11th centuries B.C., but most evidence for their existence after 1200 B.C. comes from Sardinia (see Appendix 1). In the meantime, Cyprus was becoming a major early producer of utilitarian iron objects, perhaps the first major producer in the eastern Mediterranean.<sup>1525</sup>

M. Artzy theorizes that participants in earlier, palace-controlled long-distance trade, such as the incense trade from Arabia to the Levant on land and trade in other products by sea, may have contributed to overwhelming this system when the palaces weakened; for example, Egyptian palace officials may have been involved "only in

<sup>1523</sup> Artzy 1994, 130-1.

<sup>1524</sup> Karageorghis and Demas 1984, 23-4, 26, 29-32, 60-5; 1985, 274; 1988, 261-6; Artzy 1994, 126-8; 1995, 22-5, 28.

<sup>1525</sup> Sherratt 2000, 82, 88-9; Waldbaum 1980, 84; Snodgrass 1982, 285-6; Maddin 1982, 311; Karageorghis 1982, 299.

taxation at important spots, such as Beth Shan and Megiddo” rather than in the actual transport of incense<sup>1526</sup>:

Nomads or semi-nomads (who at times would serve as intermediaries, other times as bandits, caravan leaders, or mercenaries) were the important link between Arabia, the sown lands and the established political systems... Upon the first signs of weakness, and eventually the demise of the Egyptian authorities, they slowly assumed more agricultural elements in their economy and came to inhabit areas which were already settled [for example, Tel Nami]. Likewise, it was intermediaries who might have played a large part in the sea-going transport. These intermediaries, who we would like to refer to as the ‘Nomads of the Sea’ were the emissaries of systems who needed the products; and when authority crumbled and could no longer supply the necessary economic safety, the intermediaries reverted to piracy [and independent trade as well?] and eventually settlement in areas which became known to them during their involvement in the trade. The ‘Peoples of the Sea’ would thus have been the equivalent of the ‘Peoples of the Desert.’<sup>1527</sup>

The details of Sherratt’s and Artzy’s reconstruction of the end of the Bronze Age are certainly debatable, as are most reconstructions of the c. 1200 B.C. changes in the eastern Mediterranean; however, it is clear that strong Late Cypriot cultural and economic traditions continued after those of many of their old trade partners disappear. Oxhide ingot production seems to have continued as a response to continued demand (perhaps by Sardinia in particular) for copper after c. 1200 B.C.<sup>1528</sup> This demand may have allowed the hierarchical structures developed in the LC IIC period to survive for a time. But eventually they collapsed, probably under the pressures of increased competition and unrest in the native Cypriot population as well as increasing pressure from foreign ‘refugees’ or ‘colonizers.’

<sup>1526</sup> Artzy 1994, 133-4.

<sup>1527</sup> Artzy 1994, 134.

<sup>1528</sup> Knapp 1990, 138, 149.

The export of iron objects may have also played a role in Cyprus' continued prosperity at the end of the Bronze Age—Cyprus was apparently one of the major early producers of carburized iron knives, perhaps for a 'sub-elite' market.<sup>1529</sup> While some scholars have stated that Cyprus has only insignificant unmixed iron deposits of its own, iron-rich slag byproducts from the smelting of chalcopyrite ore must have been fairly common; additionally, pure iron may have sometimes been accidentally produced during copper smelts.<sup>1530</sup> If iron export was playing a major role in Cypriot exports during the late second millennium B.C., this could have had an effect on the remains of copper smelting. Slag heaps from copper smelting may have begun to have been seen as sources of valuable raw material rather than simply as waste, and many Bronze Age copper smelting remains could have been destroyed as a result. Regardless, a Cypriot dominance of early quenched or carburized iron objects was unlikely to last, due to the wider availability of iron and the relative simplicity of the technology once the basic process is understood.<sup>1531</sup>

A social and economic environment like that described by Artzy and Sherratt may have brought about the extinction of the oxhide ingot by the end of the second millennium B.C. Although the oxhide ingot has advantages from a practical standpoint—its shape may facilitate carrying by porters, lashing to pack saddles, or stacking in the hold of a ship—it is in many respects unwieldy.<sup>1532</sup> Assyrian and Anatolian merchants involved in trading copper at Kanish in the early second

<sup>1529</sup> Sherratt 1994, 64-71; Pickles and Peltenburg 1998, 84-6.

<sup>1530</sup> Sherratt 1994, 66-7; Wertime 1980, 16; Rothenberg 1990, 182-90 Pickles and Peltenburg 1998, 79-86. V. Kassianidou argues that Cyprus has sufficient iron deposits to support an early ironworking industry and that extracting pure iron from copper smelting slags was likely an uneconomical option (Kassianidou 1994, 78-9).

<sup>1531</sup> Pickles and Peltenburg 1998, 84-5.

<sup>1532</sup> Which may, however, be the point: Tylecote (1987a) writes that large ingots were made at various times in history because the "The larger an ingot is the more difficult it is to steal" (1987a, 203).

millennium B.C. seemed to prefer broken-up ingots; the quality of the copper (number and size of inclusions and impurities, etc.) could be better assessed in this way, and smaller pieces were probably much easier to weigh. They also seem to have had no problem transporting metals over long distances on pack animals, using leather bags or “textiles for wrapping.” Oxhide ingots would need to be broken up by heating in a fire and hammering before use; a larger ingot, Tylecote points out, is “difficult to break up,” and he theorizes that “most metal workers would have been much happier with... bar ingots.”<sup>1533</sup> The decision to make larger ingots probably has more to do with accounting procedures and with simplifying the production and routine transport of extremely large amounts of metal than issues of convenience for metallurgist.

The oxhide ingot seems to have been uniquely suited to palace-based trade. They are associated with elite gift-exchanges and the palace economy from their first appearances in the archaeological and iconographic record, and gradually disappear after the collapse or reduction of palace-based states in the eastern Mediterranean. The breaking up of ingots to examine the metal’s purity may have been a necessity in the relatively small-scale copper trade conducted through Kanish in the early second millennium B.C., when many different varieties and purities of copper were being exchanged. But the large size of the oxhide ingot shape and the fact that it was often transported in this form implies that such scrutiny of the ingot’s quality was not usually considered necessary. Oxhide ingots seem to have had a well-known, standard level of purity, a theory corroborated by chemical and metallographic analyses of ingots. Their relatively high level of purity suggests centralized control of their manufacture in response to a high demand. Ingot fragments, scrap bronze, or ‘loose

---

<sup>1533</sup> Tylecote 1987a, 203; Merkel 1986b, 269.



tin' and other metals are well-suited for transactions involving smaller-scale independent merchants; metals in these forms are easily carried, weighed and assessed. Because of their size, oxhide ingots are best suited for the large transactions that characterize palace-controlled trade rather than the numerous smaller transactions of independent merchants. Their disappearance marks one of the profound changes in the role of the copper trade in the ancient Mediterranean ushered in by the development of iron metallurgy.

## WORKS CITED

- Adams, R. B., and H. Genz. 1995. "Excavations at Wadi Fidan 4, a Chalcolithic Village Complex in the Copper Ore District of Feinan, Southern Jordan." *PEQ* 127:8-20.
- Agouridis, C. 1999. "The Late Bronze Age Shipwreck at Point Iria: Discovery and Excavation." In *The Point Iria Wreck: Interconnections in the Mediterranean ca. 1200 BC*, edited by W. Phelps, Y. Lolos, and Y. Vichos, 25-42. Athens, Greece: Hellenic Institute of Marine Archaeology (HIMA).
- Albright, W. F. 1938. *The Excavations of Tell Beit Mirsim. Vol. II: The Bronze Age*. Annual of the American Schools of Oriental Research, Vol. XVII. New Haven, CT: American Schools of Oriental Research.
- Alpözen, T. O., A. H. Özdaş, and B. Berkaya. 1995. *Commercial Amphoras of the Bodrum Museum of Underwater Archaeology*. Ankara, Turkey: Dönmez Offset.
- Artzy, M. 1994. "Incense, Camels and Collared Rim Jars: Desert Trade Routes and Maritime Outlets in the Second Millennium." *OJA* 13:121-47.
- \_\_\_\_\_ 1995. "Nami: A Second Millennium International Maritime Trading Center in the Mediterranean." In *Recent Excavations in Israel: A View to the West*, edited by S. Gilin, 17-41. Archaeological Institute of America Colloquia and Conference Papers 1. Dubuque, IA: Kendall/Hunt.
- \_\_\_\_\_ 1998. "Routes, Trade, Boats, and 'Nomads of the Sea'." In *Mediterranean Peoples in Transition, Thirteenth to Early Tenth Centuries BCE*, edited by S. Gitin, A. Mazar, and E. Stern, 439-48. Jerusalem: Israel Exploration Society.
- \_\_\_\_\_ 2000. "Cult and Recycling at the End of the Late Bronze Age." In *Periplus: Festschrift für Hans-Günther Buchholz zu seinem achtzigsten Geburtstag am 24.*

- Dezember 1999*, edited by P. Åström and D. Sörenhagen, 27-31. Jonsered, Sweden: Paul Åströms Förlag.
- \_\_\_\_\_ 2006. "The Carmel Coast During the Second Part of the Late Bronze Age: A Center for Eastern Mediterranean Transshipping." *BASOR* 343: 45-64.
- Astour, M. C. 1970. "Ma'hadu, the Harbor of Ugarit." *JESHO* 13:113-27.
- \_\_\_\_\_ 1981. "Ugarit and the Great Powers." In *Ugarit in Retrospect: Fifty Years of Ugarit and Ugaritic*, edited by G. D. Young, 3-30. Winona Lake, IN: Eisenbrauns.
- Åström, P. 1966. *Excavations at Kalopsidha and Ayios Iakovos in Cyprus*. SIMA vol. II. Lund, Sweden: Carl Bloms Boktryckeri A.-B.
- \_\_\_\_\_ 1982. "The Bronzes of Hala Sultan Tekke." In *Early Metallurgy in Cyprus, 4000-500 B.C.*, edited by J. D. Muhly, R. Maddin, and V. Karageorghis, 177-84. Nicosia, Cyprus: Department of Antiquities.
- \_\_\_\_\_ 1989a. *Hala Sultan Tekke 9. Trenches 1972-1987 With an Index for Volumes 1-9*. SIMA XLV:9. Göteborg, Sweden: Paul Åströms Förlag.
- \_\_\_\_\_ 1989b. "Trade in the Late Cypriot Bronze Age." In *Early Society in Cyprus*, edited by E. Peltenburg, 202-8. Edinburgh, Scotland: Edinburgh University Press.
- \_\_\_\_\_ 1996. "Hala Sultan Tekke—a Late Cypriote Harbour Town." In *Late Bronze Age Settlement in Cyprus: Function and Relationship*, edited by P. Åström and E. Herscher, 9-14. Jonsered, Sweden: Paul Åströms Förlag.
- \_\_\_\_\_ 2000. "A Coppersmith's Workshop at Hala Sultan Tekke." In *Periplus: Festschrift für Hans-Günther Buchholz zu seinem achtzigsten Geburtstag am 24.*

- Dezember 1999*, edited by P. Åström and D. Sörenhagen, 32-5. Jonsered, Sweden: Paul Åströms Förlag.
- Åström, P., D. M. Bailey, and V. Karageorghis. 1976. *Hala Sultan Tekke 1. Excavations 1897-1971*. SIMA XLV:1. Jonsered, Sweden: Paul Åströms Förlag.
- Åström, P., G. Hult, and M. Strondberg Olofsson. 1977. *Hala Sultan Tekke 3. Excavations 1972*. SIMA XLV:3. Göteborg, Sweden: Paul Åströms Förlag.
- Åström, P., E. Åström, A. Hatziantoniou, K. Niklasson, and U. Öbrink. 1983. *Hala Sultan Tekke 8. Excavations 1971-1979*. Göteborg, Sweden: Paul Åströms Förlag.
- Bachhuber, C. 2003. "Aspects of Late Helladic Trade." M.S. thesis, Texas A&M University, College Station.
- \_\_\_\_\_. 2006. "Aegean Interest on the Uluburun Ship." *AJA* 110:345-63.
- Bachmann, H.-G. 1976. "Copper Slag Preliminary Report." In *Hala Sultan Tekke 1. Excavations 1897-1971*, edited by P. Åström, D. M. Bailey, and V. Karageorghis, 127-8. Göteborg, Sweden: Paul Åströms Förlag.
- \_\_\_\_\_. 1978. "Appendix 2: The Phase Composition of Slags from Timna Site 39." In *Chalcolithic Copper Smelting*, edited by B. Rothenberg, 21-3. Institute for Archaeo-Metallurgical Studies n. 1. London: Institute for Archaeo-Metallurgical Studies.
- \_\_\_\_\_. 1982. "Copper Smelting Slags from Cyprus: Review and Classification of Analytical Data." In *Early Metallurgy in Cyprus, 4000-500 B.C.*, edited by J. D. Muhly, R. Maddin, and V. Karageorghis, 143-52. Nicosia, Cyprus: Department of Antiquities.

- Balmuth, M. S., and R. J. Rowland (eds.). 1984. *Studies in Sardinian Archaeology*. Ann Arbor, MI: University of Michigan Press.
- Balthazar, J. W. 1990. *Copper and Bronze Working in Early Through Middle Bronze Age Cyprus*. Jonsered, Sweden: Paul Åström Förlag.
- Bamberger, M., and P. Wincierz. 1990. "Ancient Smelting of Oxide Copper Ore. In *The Ancient Metallurgy of Copper*, edited by B. Rothenberg, 123-57. London: Institute for Archaeo-Metallurgical Studies, Institute of Archaeology, University College, London.
- Bamberger, M., P. Wincierz, H.-G. Bachmann, and B. Rothenberg. 1986. "Ancient Smelting of Oxide Copper Ore." *Metall*, 40.1:2-10.
- Bar-Adon, P. 1980. *The Cave of the Treasure*. Jerusalem: Israel Exploration Society.
- Bass, G. F. 1967. *Cape Gelidonya: A Bronze Age Shipwreck*. Transactions of the American Philosophical Society, v. 57, pt. 8. Philadelphia, PA: The American Philosophical Society.
- \_\_\_\_\_ 1976. "Sheytan Deresi: Preliminary Report." *IJNA* 5(4):293-303.
- \_\_\_\_\_ 1986. "A Bronze Age Shipwreck at Ulu Burun (Kaş): 1984 Campaign." *AJA* 90:269-96.
- \_\_\_\_\_ 1991. "Evidence of Trade from Bronze Age Shipwrecks." In *Bronze Age Trade in the Mediterranean*, edited by N. H. Gale, 69-82. Göteborg, Sweden: Paul Åströms Förlag.
- Bass, G. F., C. Pulak, D. Collon, and J. Weinstein. 1989. "The Bronze Age Shipwreck at Uluburun: 1986 Campaign." *AJA* 93:1-29.

- Bear, M. L. 1963. *The Mineral Resources and Mining Industry of Cyprus*. Nicosia, Cyprus: Republic of Cyprus Ministry of Commerce and Industry, Geological Survey Department.
- Becker, M. J. 1980. "Sardinia and the Mediterranean Copper Trade: Political Development and Colonialism in the Bronze Age (1)". *Anthropology* 4.2:91-117.
- \_\_\_\_\_ 1984. "Sardinian Stone Moulds: An Indirect Means of Evaluating Bronze Age Metallurgical Technology." In *Studies in Sardinian Archaeology*, edited by M. S. Balmuth and R. J. Rowland, 163-208. Ann Arbor, MI: The University of Michigan Press.
- Begemann, F., S. Schmitt-Strecker, E. Pernicka, and F. LoSchiavo. 2001. "Chemical Composition and Lead Isotopy of Copper and Bronze from Nuragic Sardinia." *EJA* 4:43-85.
- Belgiorno, M. R. 1999. "Preliminary Report on Pyrgos Excavations 1996, 1997." *RDAC*:71-86.
- \_\_\_\_\_ 2000. "Project 'Pyrame' 1998-1999: Archaeological, Metallurgical and Historical Evidence at Pyrgos (Limassol)." *RDAC*:1-17.
- Belli, O. 2004. *Anadolu'da Kalay ve Bronzun Tarihçesi*. Istanbul, Turkey: Vehbi Koç Vakfı.
- Benvenuti, M., L. Charantini, L. Norfini, A. Casini, S. Guideri, and G. Tanelli. 2003. "The 'Etruscan Tin': A Preliminary Contribution from Researches at Monte Valerio and Baratti—Popolonia (Southern Tuscany, Italy)." In *The Problem of Early Tin*, edited by A. Giumlia-Mair and F. LoSchiavo, 55-66. BAR-IS 1199. Oxford, England: Archaeopress.

- Betancourt, P., T. S. Wheeler, R. Maddin, and J. D. Muhly. 1978. "Metallurgy at Gournia." *MASCA Journal* 1:7-8.
- Betancourt, P. P., J. D. Muhly, W. R. Farrand, C. Stearns, L. Onyshkevych, W. B. Hafford, and D. Evely. 1999. "Research and Excavation at Chrysokamino, Crete 1995-1998." *Hesperia* 68(3):343-70.
- Bietak, M. 1995. "Connections Between Egypt and the Minoan World: New Results from Tell el-Dab'a /Avaris." In *Egypt, the Aegean, and the Levant: Interconnections in the Second Millennium BC*, edited by W. V. Davies and L. Schofield, 19-28, Pl. 1-4. London: British Museum Press.
- Bisson de la Roque, F. 1950. *Tresor de Tôd*. Cairo, Egypt: Imprimerie de L'Institut Français Archéologie Orientale.
- Blake, E. 1997. "Strategic Symbolism: Miniature Nuraghi of Sardinia." *JMA* 10(2):151-64.
- Blitzer, H. 1995. "Minoan Implements and Industries." In *Kommos I. The Kommos Region and Houses of the Minoan Town. Part 1: The Kommos Region, Ecology, and Minoan Industries*, 403-536. Princeton, NJ: Princeton University Press.
- Bourriau, J., L. Smith, and M. Serpico. 2001. "The Provenance of Canaanite Amphorae Found at Memphis and Amarna in the New Kingdom." In *The Social Context of Technological Change: Egypt and the Near East, 1650-1550 BC: Proceedings of a Conference Held at St, Edmund's Hall, Oxford, 12-14 September 2000*, edited by A. Shortland, 113-46. Oxford UK: Oxbow Books.
- Bouzek, J. 1985. *The Aegean, Anatolia, and Europe: Cultural Interrelations in the Second Millennium B.C.* SIMA 29. Göteborg, Sweden: Paul Åströms Förlag.

- Bradley, J. W., and S. T. Childs. 1991. "Basque Earrings and Panther's Tails: The Form of Cross-Cultural Contact in Sixteenth Century Iroquoia." In *Metals in Society: Theory Beyond Analysis*, edited by R. M. Ehrenreich, 7-18. MASCA Research Papers in Science and Archaeology, v. 8, pt. II. Philadelphia, PA: MASCA, The University Museum of Archaeology and Anthropology.
- Bradley, R., and M. Edmonds. 1993. *Interpreting the Axe Trade: Production and Exchange in Neolithic Britain*. Cambridge, UK: Cambridge University Press.
- Branigan, K. 1968. *Copper and Bronze Working in Early Bronze Age Crete*. Studies in Mediterranean Archaeology v. XIX. Lund, Sweden: Carl Bloms Boktryckeri A.-B.
- \_\_\_\_\_. 1974. *Aegean Metalwork of the Early and Middle Bronze Age*. Oxford UK: Clarendon Press.
- \_\_\_\_\_. 1982. "Minoan Metallurgy and Cypriot Copper." In *Early Metallurgy in Cyprus, 4000-500 B.C.*, edited by J. D. Muhly, R. Maddin, and V. Karageorghis, 203-12. Nicosia, Cyprus: Department of Antiquities.
- Braudel, F. 1995. *The Mediterranean and the Mediterranean World in the Age of Philip II*, v. I. Translated by S. Reynolds. Berkeley: University of California Press.
- Brinkman, J. A. 1987. "Twenty Minas of Copper." In *Language, Literature, and History: Philological and Historical Studies Presented to Erica Reiner*, edited by F. Rochberg-Halton, 33-6. American Oriental Series, vol. 67. New Haven, CT: American Oriental Society.
- Broodbank, C. 1993. "Ulysses Without Sails: Trade, Distance, Knowledge, and Power in the Early Cyclades." *WorldArch* 24(3):315-31.



- Bruce, J. L. 1937. "Antiquities in the Mines of Cyprus." In *Swedish Cyprus Expedition* 3, edited by E. Gjerstad, J. Lindros, E. Sjöquist, and A. Westholm, 639-71. Stockholm: Swedish Cyprus Expedition.
- Buchanan, B. 1966. *Catalogue of Ancient Near Eastern Seals in the Ashmolean Museum Volume I: Cylinder Seals*. Oxford UK: Clarendon Press.
- Buchholz, H.-G. 1959. "Keftiubarren und Erzhandel im zweiten vorchristlichen Jahrtausend." *PZ XXXVII*, p. 1-40.
- \_\_\_\_\_ 1988. "Der Metallhandel des zweiten Jahrtausends im Mittelmeer." In *Society and Economy in the Eastern Mediterranean (c. 1500-1000 B.C.)*, edited by M. Heltzer and E. Lipiński, 187-228. Leuven, Belgium: Orientaliste.
- \_\_\_\_\_ 2003. "Einige Zyprische Gußformen." *RDAC*: 113-38.
- Buchholz, H.-G., and V. Karageorghis. 1973. *Prehistoric Greece and Cyprus: An Archaeological Handbook*. Translated by F. Garvie. London: Phaidon Press Ltd.
- Buchholz, H.-G., and G. Weisgerber. 2005. "Prominenz mit Steingerät." In *Das Schiff von Uluburun. Welthandel vor 3000 Jahren*, edited by Yalçın, Ü., C. Pulak, and R. Slotta, 149-56. Bochum, Germany: Deutsches Bergbau-Museum.
- Budd, P., A. M. Pollard, B. Scaife, and R. G. Thomas. 1995a. "Oxhide Ingots, Recycling, and the Mediterranean Metals Trade." *JMA* 8(1):1-32.
- \_\_\_\_\_ 1995b. "Lead Isotope Analysis and Oxhide Ingots: A Final Comment." *JMA* 8(1):70-5.
- Burnet, J. E. 2004. *Forest Bioresource Utilisation in the Eastern Mediterranean since Antiquity. A case study of Makheras, Cyprus*. BAR-IS 1243. Oxford UK: Archaeopress.

Cadogan, G. 1989. "Maroni and her monuments." In *Early Society in Cyprus*, edited by E. Peltenburg, 43-51. Edinburgh, Scotland: Edinburgh University Press.

\_\_\_\_\_ 1996. "Maroni: Change in Late Bronze Age Cyprus." In *Late Bronze Age Settlement in Cyprus: Function and Relationship*, edited by P. Åström and E. Herscher, 15-22. Jonsered, Sweden: Paul Åströms Förlag.

\_\_\_\_\_ 1998. "The Thirteenth Century Changes in Cyprus in their Eastern Mediterranean Context." In *Mediterranean Peoples in Transition, Thirteenth to Early Tenth Centuries BCE*, edited by S. Gitin, A. Mazar, and E. Stern, 6-16. Jerusalem: Israel Exploration Society.

Catling, H. W. 1957. "The Metal Objects and Coins." In *Myrtou-Pigadhes. A Late Bronze Age Sanctuary in Cyprus*, by J. du Plat Taylor, 86-91. Oxford UK: Ashmolean Museum.

\_\_\_\_\_ 1964. *Cypriot Bronzework in the Mycenaean World*. London: Oxford University Press.

\_\_\_\_\_ 1971. "A Cypriot Bronze Statuette in the Bomford Collection." In *Alasia I*, edited by C. F.-A. Schaeffer, 15-32. Leiden, Holland: E. J. Brill.

Chadwick, J. 1976. *The Mycenaean World*. Cambridge, UK: Cambridge University Press.

Charles, J. A. 1967. "Early Arsenical Bronzes—A Metallurgical View." *AJA* 71:21-6.

\_\_\_\_\_ 1980. "The Coming of Copper and Copper-Base Alloys and Iron: A Metallurgical Sequence." In *The Coming of the Age of Iron*, 151-82. New Haven, CT: Yale University Press.

- Cherry, J. F., and A. B. Knapp. 1991. "Quantitative Provenience Studies and Bronze Age Trade in the Mediterranean: Some Preliminary Reflections." In *Bronze Age Trade in the Mediterranean*, edited by N. H. Gale, 92-120. SIMA v. XC. Jonsered, Sweden: Paul Åströms Förlag.
- Childs, S. T. 1998. "Find the *Ekijunjumira*? Iron Mine Discovery, Ownership, and Power among the Toro of Uganda." In *Social Approaches to an Industrial Past: The Archaeology and Anthropology of Mining*, edited by A. B. Knapp, V. C. Piggott, and E. W. Herbert, 123-38. London: Routledge.
- Ciorny, J., and G. Weisberger. 2003. "Bronze Age Tin Mines in Central Asia." In *The Problem of Early Tin*, edited by A. Giunlia-Mair and F. LoSchiavo, 23-34. BAR-IS 1199. Oxford UK: Archaeopress.
- Ciorny, J., T. Stöllner, and G. Weisgerber. 2005. "Zinn in und aus Mittelasien." In *Das Schiff von Uluburun. Welthandel vor 3000 Jahren*, edited by Yalçin, Ü., C. Pulak, and R. Slotta, 431-48. Bochum, Germany: Deutsches Bergbau-Museum.
- Cleuziou, S., and T. Berthoud. 1982. "Early Tin in the Near East: A Reassessment in the Light of New Evidence from Western Afghanistan." *Expedition* 25(1):14-9.
- Cline, E. H. 1994. *Sailing the Wine-Dark Sea: International Trade and the Late Bronze Age*. BAR-IS 591. Oxford UK: Hadrian Books.
- \_\_\_\_\_ 1995a. "My Brother, My Son!: Rulership and Trade Between the LBA Aegean, Egypt, and the Near East." In *The Role of the Ruler in the Prehistoric Aegean*, edited by P. Rehak, 143-50. *Aegeum* 11. Liège, Belgium: R. Laffiner.
- \_\_\_\_\_ 1995b. "Egyptian and Near Eastern Imports at Late Bronze Age Mycenae." In *Egypt, the Aegean, and the Levant: Interconnections in the Second Millennium*

*BC*, edited by W. V. Davies and L. Schofield, 91-114. London: British Museum Press.

Coghlan, H. H. 1975. *Notes on the Metallurgy of Copper and Bronze in the Old World*. Oxford UK: Oxford University Press.

Coldstream, J. N. 1989. "Status Symbols in the Eleventh Century BC." In *Early Society in Cyprus*, edited by E. Peltenburg, 325-35. Edinburgh, Scotland: Edinburgh University Press.

Constantinou, G. 1982. "Geological Features and Ancient Exploitation of the Cupriferos Sulphide Orebodies of Cyprus." In *Early Metallurgy in Cyprus, 4000-500 B.C.*, edited by J. D. Muhly, R. Maddin, and V. Karageorghis, 13-24. Nicosia, Cyprus: Department of Antiquities.

\_\_\_\_\_ 1992. "Ancient Copper Mining in Cyprus." In *Cyprus, Copper, and the Sea*, edited by A. Marangou and K. Psillides, 43-76. Nicosia: Government of Cyprus.

Courtois, J.-C. 1971. "Le Sanctuaire du Dieu au Lingot D'Enkomi-Alasia." In *Alasia I*, edited by C. F.-A. Schaeffer, 151-366. Leiden, Holland: E. J. Brill.

\_\_\_\_\_ 1982. "L' Activité Métallurgique et Les Bronzes d'Enkomi au Bronze Récent (1650-1100 avant J. C.)." In *Early Metallurgy in Cyprus, 4000-500 B.C.*, edited by J. D. Muhly, R. Maddin, and V. Karageorghis, 155-76. Nicosia, Cyprus: Department of Antiquities.

Courtois, J.-C., and E. Lagarce. 1986. *Enkomi et Le Bronze Récent à Chypre*. Nicosia, Cyprus: A. G. Leventis Foundation.

- Craddock, P. T. 1995. *Early Metal Mining and Production*. Washington D.C.: Smithsonian Institution Press.
- Craddock, P. T., I. C. Freestone, and C. D. Dawe. 1997. "Casting Metals in Limestone Moulds." *The Journal of the Historical Metallurgy Society* 31(1):1-7.
- Cummer, W. W., and E. Schofield. 1984. *Keos III. Ayia Irini: House A*. Mainz on Rhine, Germany: Verlag Philipp von Zabern.
- Cunliffe, B. (ed.). 2001. *The Oxford Illustrated History of Prehistoric Europe*. Oxford UK: Oxford University Press.
- Curtis, A. 1985. *Ugarit/Ras Shamra*. Grand Rapids, MI: William B. Eerdsman Publishing.
- Dalley, S. 1986. "Near Eastern Patron Deities of Mining and Smelting in the Late Bronze Age and Early Iron Ages." *RDAC*:63-8, Pl. XIX.
- Davey, C. J. 1979. "Some Ancient Near Eastern Pot Bellows." *Levant* 11:101-11.
- \_\_\_\_\_ 1988. "Tell Edh-Dhiba'i and the Southern Near Eastern Metalworking Tradition." In *The Beginning of the Use of Metals and Alloys*, edited by R. Maddin, 63-8. Cambridge, MA: The MIT Press.
- Davies, N. de G. 1935. "The King as Sportsman." *BMMA* 30(2): 49-52.
- \_\_\_\_\_ 1973. Reprint. *The Tomb of Rekh-mi-re at Thebes*. New York: Arno Press. Original edition, New York, Metropolitan Museum of Art, 1944.
- Davies, O. 1979. *Roman Mines in Europe*. New York: Arno Press.
- Day, P. M. 1999. "Petrographic Analysis of Ceramics from the Shipwreck at Point Iria." In *The Point Iria Wreck: Interconnections in the Mediterranean ca. 1200 BC*,

- edited by W. Phelps, Y. Lolos, and Y. Vichos, 59-76. Athens, Greece: Hellenic Institute of Marine Archaeology (HIMA).
- De Jesus, S. P. 1978. "Metal Resources in Ancient Anatolia." *AnatSt* 28:97-102.
- Demakopoulou, K. 1998. "Shipwrecks in the Eastern Mediterranean." In *Gods and Heroes of the European Bronze Age*, edited by K. Demakopoulou, C. Eluère, J. Jensen, A. Jockenhövel, and J.-P. Mohen, 35-7. New York: Thames & Hudson.
- Denk, R. 1995. "Die Verschiedenen Formen der Sog, Katanga Kreuze." In *Kissipenny und Manilla: Geld und Handel in Alten Afrika*, edited by S. Lux and R. Althoff, 65-80. Duisberg, Germany: Kultur- und Tadtgeschichtliches Museum, Duisberg.
- Derckson, J. G. 1996. *The Old Assyrian Copper Trade in Anatolia*. Istanbul, Turkey: Nederlands Historisch-Archaeologisch Instituut.
- Dever, W. G., and M. Tadmor. 1976. "A Copper Hoard of the Middle Bronze Age I." *IEJ* 26: 163-9.
- Dietz, S. 1984. *Lindos IV, 1. Excavations and Surveys in Southern Rhodes: The Mycenaean Period*. Odense, Denmark: AiO Print Ltd.
- Dikaios, P. 1969a. *Enkomi: Excavations 1948-58. Volume I: The Architectural Remains; The Tombs*. Mainz am Rhein, Germany. Verlag Philipp von Zabern.
- \_\_\_\_\_ 1969b. *Enkomi: Excavations 1948-58. Volume IIIa: Plates*. Mainz am Rhein, Germany: Verlag Philipp von Zabern.
- \_\_\_\_\_ 1969c. *Enkomi: Excavations 1948-58. Volume IIIb: Plans*. Mainz am Rhein, Germany: Verlag Philipp von Zabern.

- \_\_\_\_\_ 1971. *Enkomi: Excavations 1948-58. Volume II: Chronology, Summary, and Conclusions, Catalogue, Appendices*. Mainz am Rhein, Germany: Verlag Philipp von Zabern.
- Dimitrov, B. 1979. "Underwater Research Along the South Bulgarian Black Sea Coast in 1976 and 1977." *IJNA* 8(1):70-79.
- Dimopoulou, N. 1997. "Workshops and Craftsmen in the Harbour-Town of Knossos at Poros-Katsambas." In *TEXNH: Craftsmen, Craftswomen, and Craftsmanship in the Aegean Bronze Age*, edited by R. Laffineur and P. P. Betancourt, p. 433-8. *Aegeum* 16. Liège, Belgium: Universite die Liège.
- Domergue, C., and C. Rico. 2002. "À Propos de Deux Lingots de Cuivre Antiques Trouvés en Mer sur la Côte Languedocienne." In *Vivre, Produire et Échanger: Reflets Méditerranéens. Mélanges Offerts à Bernard Liou*, 141-52. Montagnac, France: Editions Monique Mergoil.
- Doonan, R. C. P. 1999. "Copper Production in the Eastern Alps during the Bronze Age: Technological Change and the Unintended Consequences of Social Reorganization." In *Metals in Antiquity*, edited by S. M. M. Young, A. Mark Pollard, P. Budd, and R. A. Ixer, 72-7. BAR-IS 792. Oxford UK: Archaeopress.
- Dothan, T., and A. Ben-Tor. 1983. *Excavations at Atheniou, Cyprus 1971-1972*. Jerusalem: Ahva Press.
- Drews, R. 1993. *The End of the Bronze Age: Changes in Warfare and the Catastrophe ca. 1200 B.C.* Princeton, NJ: Princeton University Press.
- Du Plat Taylor, J. 1952. "A Late Bronze Age Settlement at Apliki, Cyprus." *AntJ* XXXII:133-67.

- Durham, E. 1971. Reprint. *High Albania*. New York: Arno Press & the New York Times. Original edition, London: Edward Arnold, 1909.
- Edens, C. M., and P. L. Kohl. 1993. "Trade and World Systems in Early Bronze Age Western Asia." In *Trade and Exchange in Prehistoric Europe*, edited by C. Scarre and F. Healy, 17-34. Oxbow Monographs 33. Oxford UK: Oxbow Books.
- Elliott, C. 1984. "Appendix III. The Ground Stone Industry of Pyla-Kokkinokremos." In *Pyla-Kokkinokremos: A Late 13<sup>th</sup>-Century B.C. Fortified Settlement in Cyprus*, by V. Karageorghis and M. Demas, 86-94. Nicosia, Cyprus: Chr. Nicolaus & Sons Ltd.
- Evely, R. D. G. 2000. *Minoan Crafts: Tools and Techniques. Volume 2*. Jonsered, Sweden: Paul Åströms Förlag.
- Fadda, M. A. 2003. "The Discovery of Tin Near the 'Megaron Temple' of S'Arcu'e is Forras (Villagrande Strisaili, Nuoro)." In *The Problem of Early Tin*, edited by A. Giumlia-Mair and F. LoSchiavo, 133-8. BAR-IS 1199. Oxford UK: Archaeopress.
- Fasnacht, W. 1989. "Excavations at Ayia Varvara-*Almyras*." *RDAC*:59-76, Pl. V-VI.
- \_\_\_\_\_ 1999. "Excavations at Ayia Varvara-*Almyras*: A Review of Twelve Years of Research." *RDAC*:174-84.
- \_\_\_\_\_ 2005. "Bergbau und Kupfergewinnung auf Zypern." In *Das Schiff von Uluburun. Welthandel vor 3000 Jahren*, edited by Yalçın, Ü., C. Pulak, and R. Slotka, 515-25. Bochum, Germany: Deutsches Bergbau-Museum.
- Finley, M. I. 2002. *The World of Odysseus*. New York: New York Review of Books.



- Forbes, R. J. 1966. *Studies in Ancient Technology*, v. VI: *Heat and Heating, Refrigeration, Light*. Leiden, Holland: E. J. Brill.
- \_\_\_\_\_ 1963. *Studies in Ancient Technology*, v. VII. Leiden, Holland: E. J. Brill.
- \_\_\_\_\_ 1964a. *Studies in Ancient Technology*, v. VIII. Leiden, Holland: E. J. Brill.
- \_\_\_\_\_ 1964b. *Studies in Ancient Technology*, v. IX. Leiden, Holland: E. J. Brill.
- Forenbaher, S. 1995. "Trade and Exchange in Late Bronze Age and Early Iron Age Croatia." In *Handel, Tausch und Verkehr im Bronze- und Früheisenzeitlichen Südosteuropa*, edited by B. Hänsel, 316-82. München, Germany: Seminar für Ur- und Frühgeschichte der Freier Universität zu Berlin.
- Frankel, D. 1993. "Inter- and Intrasite Variability and Social Interaction in Prehistoric Bronze Age Cyprus: Types, Ranges, and Trends." *BASOR* 292:59-72.
- Freed, R. E., Y. J. Markowitz, and S. H. D'Auria (eds.). 1999. *Pharaohs of the Sun*. Boston, MA: Bulfinch Press/Little, Brown & Co.
- Freestone, I. C. 1989. "Refractory Materials and Their Procurement." In *Old World Archaeometallurgy*, edited by A. Hauptmann, E. Pernicka, and G. A. Wagner, 155-62. Bochum, Germany: Selbstverlag des Deutschen Bergbau-Museums.
- Gale, N. H. 1989. "Archaeometallurgical Studies of Late Bronze Age Ox-Hide Copper Ingots from the Mediterranean Region." In *Old World Archaeometallurgy*, edited by A. Hauptmann, E. Pernicka, and G. A. Wagner, 247-68. Bochum, Germany: Selbstverlag des Deutschen Bergbau-Museums.
- \_\_\_\_\_ 1991. "Copper Oxhide Ingots: their Origin and their Place in the Bronze Age Metals Trade in the Mediterranean." In *Bronze Age Trade in the*

*Mediterranean*, edited by N. H. Gale, 197-240. SIMA v. XC. Jonsered, Sweden: Paul Åströms Förlag.

\_\_\_\_\_ 1998. "The Role of Kea in Metal Production and Trade in the Late Bronze Age." In *Kea-Kythnos: History and Archaeology*, edited by L. G. Mendoni and A. J. Mazarakis Ainian, 737-58. Athens, Greece: Research Center for Greek and Roman Antiquity/National Hellenic Research Foundation.

\_\_\_\_\_ 1999. "Lead Isotope Characterization of the Ore Deposits of Cyprus and Sardinia and its Application to the Discovery of the Sources of Copper for Late Bronze Age Oxhide Ingots." In *Metals in Antiquity*, edited by S. M. M. Young, A. Mark Pollard, P. Budd, and R. A. Ixer, 110-21. BAR-IS 792. Oxford UK: Archaeopress.

\_\_\_\_\_ 2001. "Archaeology, Science-Based Archaeology, and the Mediterranean Bronze Age Metals Trade: A Contribution to the Debate." *EJA* 4: 113-30.

\_\_\_\_\_ 2005. "Die Kupferbarren von Uluburun. Teil 2. Bleiisotopenanalysen von Bohrkernen aus den Barren." In *Das Schiff von Uluburun. Welthandel vor 3000 Jahren*, edited by Yalçın, Ü., C. Pulak, and R. Slotta, 141-8. Bochum, Germany: Deutsches Bergbau-Museum

Gale, N. H., and Z. A. Stos-Gale. 1985. "Lead Isotope Analysis and Alashiya: 3." *RDAC*:83-99.

\_\_\_\_\_ 1986. "Oxhide Ingots in Crete and Cyprus and the Bronze Age Metals Trade." *ABSA* 81:81-100.

\_\_\_\_\_ 1987. "Oxhide Ingots from Sardinia, Crete and Cyprus and the Bronze Age Copper Trade: New Scientific Evidence." In *Studies in Sardinian Archaeology*

*III: Nuragic Sardinia and the Mycenaean World*, edited by M. S. Balmuth, 135-78. BAR-IS 387. Oxford UK: British Archaeological Reports.

\_\_\_\_\_ 1988. "Recent Evidence for a Possible Bronze Age Metal Trade between Sardinia and the Aegean." In *Problems in Greek Prehistory*, edited by E. B. French and K. A. Wardle, 349-84. Papers Presented at the Centenary Conference of the British School of Archaeology at Athens, Manchester, April 1986. Bristol, UK: Bristol Classical Press.

\_\_\_\_\_ 1999. "Copper Oxhide Ingots and the Aegean Metals Trade. New Perspectives." In *Meletemata: Studies in Aegean Archaeology Presented to Malcolm H. Wiener as He Enters His 65<sup>th</sup> Year, v. 1*, edited by P. P. Betancourt, V. Karageorghis, R. Laffineur, and W.-D. Niemeier, 267-78, Pl. LVIII-LIX. Eupen, Belgium: Kliemo SA B-4700.

\_\_\_\_\_ 2005. "Zur Herkunft der Kupferbarren aus dem Schiffswrack von Uluburun und der Spätbronzezeitliche Metallhandel im Mittelmeerraum." In *Das Schiff von Uluburun. Welthandel vor 3000 Jahren*, edited by Yalçın, Ü., C. Pulak, and R. Slotta, 117-32. Bochum, Germany: Deutsches Bergbau-Museum.

Gale, N. H., Z. A. Stos-Gale, and W. Fasnacht. 1996. "Copper and Copper Working at Alambra." In *Alambra: A Middle Bronze Age Settlement in Cyprus: Archaeological Investigations by Cornell University 1974-1985*, edited by J. E. Coleman, M. K. Mogelonsky, and K. W. Schaar, 359-402. SIMA 118. Jonsered, Sweden: Paul Åströms Förlag.

Gale, N. H., A. Papastamataki, Z. A. Stos-Gale, and K. Leonis. 1985. "Copper sources and copper metallurgy in the Aegean Bronze Age." In *Furnaces and Smelting*

*Technology in Antiquity*, edited by P. T. Craddock and M. J. Hughes, 81-102.

British Museum Occasional Paper No. 48. London: British Museum Publications.

Gale, N. H. Z. Stos-Gale, A. Raduncheva, I. Panayotov, I. Ivanov, P. Lilov and T.

Todorov. 2003. "Early Metallurgy in Bulgaria." In *Mining and Metal Production Through the Ages*, edited by P. T. Craddock and J. Lang, 122-73. London: British Museum Press.

Galili, E., N. Schmueli, and M. Artzy. 1986. "Bronze Age Ship's Cargo of Copper and Tin." *IJNA* 15(1):25-37.

Gallin, L. J., and R. H. Tykot. 1993. "Metallurgy at Nuraghe Santa Barbara (Bauladu), Sardinia." *JFA* 20:336-45.

Garstang, J. 1953. *Prehistoric Mersin: Yümük Tepe in Southern Turkey*. London: Oxford University Press.

Georgiou, H. 1979. "Relations Between Cyprus and the Near East in the Middle and Late Bronze Age." *Levant* 11:84-100.

Giardino, C. 1987. "The Early Exploitation of Mines and Working of Metal in Sardinia."

In *Studies in Sardinian Archaeology III: Nuragic Sardinia and the Mycenaean World*, 220-2. BAR-IS 387. Oxford UK: British Archaeological Reports.

\_\_\_\_\_ 1992. "Nuragic Sardinia and the Mediterranean: Metallurgy and Maritime Traffic." In *Sardinia in the Mediterranean: A Footprint in the Sea*, edited by R. H. Tykot and T. K. Andrews, 304-16. Sheffield, UK: Sheffield Academic Press.

\_\_\_\_\_ 2000a. "Prehistoric Copper Activity at Pyrgos." *RDAC*:19-32.

- \_\_\_\_\_ 2000b. "Sicilian Hoards and Protohistoric Metal Trade in the Central West Mediterranean." In *Metals Make the World Go Round: The Supply and Circulation of Metals in Bronze Age Europe. Proceedings of a Conference held at the University of Birmingham in June 1997*, edited by C. F. E. Pare, 99-107. Oxford UK: Oxbow Books.
- Giardino, C., G. E. Gigante, and S. Ridolfi. 2002. "Archaeometallurgical Investigations on the Early-Middle Bronze Age Finds from the Area of Pyrgos (Limassol). *RDAC*:33-48.
- Gillis, C. 1999a. "The Significance of Color for Metals in the Aegean Bronze Age." In *Meletemata: Studies in Aegean Archaeology Presented to Malcolm H. Wiener as He Enters His 65<sup>th</sup> Year*, edited by P. P. Betancourt, V. Karageorghis, R. Laffineur, and W.-D. Niemeier, v. 1, 289-98. Eupen, Belgium: KLIEMO-SA B-4700.
- \_\_\_\_\_ 1999b. "The Economic Value and Colour Symbolism of Tin." In *Metals in Antiquity*, edited by S. M. M. Young, A. M. Pollard, P. Budd and R. A. Ixer, 140-5. BAR-IS 792. Oxford UK: Archaeopress.
- Gitin, S., A. Mazar, and E. Stern (eds.). 1998. *Mediterranean Peoples in Transition: Thirteenth to Tenth Centuries BC*. Jerusalem: Israel Exploration Society.
- Giumlia-Mair, A. 2003. "Iron Age Bronze and Tin in the Oriental Alps." In *The Problem of Early Tin*, edited by A. Giumlia-Mair and F. LoSchiavo, 93-108. BAR-IS 1199. Oxford UK: Archaeopress.
- \_\_\_\_\_ 2005. "Handel und Rohstoffgewinnung im Italien der späten Bronzezeit." In *Das Schiff von Uluburun. Welthandel vor 3000 Jahren*, edited by Yalçın, Ü.,

- C. Pulak, and R. Slotta, 415-30. Bochum, Germany: Deutsches Bergbau-Museum.
- Given, M., and A. B. Knapp. 2003. *The Sydney Cyprus Survey Project: Social Approaches to Regional Archaeological Survey*. Monumenta Archaeologica 21, Cotsten Institute of Archaeology. Los Angeles: University of California.
- Given, M., A. B. Knapp, N. Meyer, T. E. Gregory, V. Kassianidou, J. Noller, L. Wells, N. Urwin, and H. Wright. 1999. "The Sydney Cyprus Survey Project: An Interdisciplinary Investigation of Long-Term Change in the North-Central Troodos." *JFA* 26:19-39.
- Glumac, P. D., and J. A. Todd. 1991. "Early Metallurgy in Southeast Europe: The Evidence for Production." In *Recent Trends in Archaeometallurgical Research*, edited by P. D. Glumac, 8-20. *MASCA Research Papers in Science and Archaeology*, v. 8, pt. 1. Philadelphia, PA: The University Museum of Archaeology and Anthropology, University of Pennsylvania.
- Gödecken, K. B. 1988. "A Contribution to the Early History of Miletus. The Settlement in Mycenaean Times and its Connections Overseas." In *Problems in Greek Prehistory*, edited by E. B. French and K. A. Wardle, 307-18. Papers Presented at the Centenary Conference of the British School of Archaeology at Athens, Manchester, April 1986. Bristol, UK: Bristol Classical Press.
- Goldman, H. 1956. *Excavations at Gözli Kule, Tarsus. Volume II: From the Neolithic through the Bronze Age*. Princeton, NJ: Princeton University Press.

- Goren, Y., S. Bunimovitz, I. Finkelstein, and N. Na'aman. 2003. "The Location of Alashiya: New Evidence from Petrographic Investigation of Alashiyan Tablets from El-Amarna and Ugarit." *AJA* 107:233-55.
- Gurney, O. R. 1952. *The Hittites*. London: Penguin Books.
- Güterbock, H. G. 1983. "The Hittites and the Aegean World: Part 1. The Ahhiyawa Problem Reconsidered." *AJA* 87:133-8.
- \_\_\_\_\_ 1997a. "The Hittite Conquest of Cyprus Reconsidered." In *Perspectives on Hittite Civilization: Selected Writings of Hans Gustav Güterbock*, edited by H. A. Hoffner and I. L. Diamond, 193-8. Oriental Institute of the University of Chicago Assyriological Studies No. 26. Saline, MI: McNaughton & Gunn, Inc.
- \_\_\_\_\_ 1997b. "Hittites and Akhaeans: A New Look." In *Perspectives on Hittite Civilization: Selected Writings of Hans Gustav Güterbock*, edited by H. A. Hoffner and I. L. Diamond, 205-10. Oriental Institute of the University of Chicago Assyriological Studies No. 26. Saline, MI: McNaughton & Gunn, Inc.
- Hadjisavvas, S. 1986. "Alassa. A New Late Cypriote Site." *RDAC*:62-7, Pl. XVI-XVIII.
- \_\_\_\_\_ 1989. "A Late Cypriot Community at Alassa." In *Early Society in Cyprus*, edited by E. Peltenburg, 32-42. Edinburgh, Scotland: Edinburgh University Press.
- \_\_\_\_\_ 1996. "Alassa: A Regional Centre of Alasia?" In *Late Bronze Age Settlement in Cyprus: Function and Relationship*, edited by P. Åström and E. Herscher, 23-38. Jonsered, Sweden: Paul Åströms Förlag.
- Hakulin, L. 2004. *Bronzeworking on Late Minoan Crete: A Diachronic study*. BAR-IS 1245. Oxford UK: Archaeopress.

- Hallager, B. P. 1985. "Crete and Italy in the Late Bronze Age III Period." *AJA* 89:293-305, Pl. 38.
- Harding, A. F. 2000. *European Societies in the Bronze Age*. Cambridge, UK: Cambridge University Press.
- Harmankaya, N. S. 1995. "Kozman Deresi Mevkii (Şarköy, Tekirdağ) Maden Buluntulury." In *Readings in Prehistory. Studies Presented to Halet Çambel*, 217-54. Istanbul, Turkey: Graphis.
- Hauptmann, A. 1989. "The Earliest Periods of Copper Metallurgy in Feinan/Jordan." In *Old World Archaeometallurgy*, edited by A. Hauptmann, E. Pernicka, and G. A. Wagner, 119-36. Bochum, Germany: Selbstverlag des Deutschen Bergbau-Museums.
- \_\_\_\_\_ 2003. "Developments in Copper Metallurgy During the Fourth and Third Millennium BC at Feinan, Jordan." In *Mining and Metal Production Through the Ages*, edited by P. T. Craddock and J. Lang, 90-100. London: British Museum Press.
- \_\_\_\_\_ 2005. "Aspekte zum Handwerk bronzzeitlicher Metallurgen." In *Das Schiff von Uluburun. Welthandel vor 3000 Jahren*, edited by Yalçın, Ü., C. Pulak, and R. Slotta, 475-83. Bochum, Germany: Deutsches Bergbau-Museum.
- Hauptmann, A., and R. Maddin. 2005. "Die Kupferbarren von Uluburun. Teil 1. Qualitätsmetall für den Weltmarkt?" In *Das Schiff von Uluburun. Welthandel vor 3000 Jahren*, edited by Yalçın, Ü., C. Pulak, and R. Slotta, 133-40. Bochum, Germany: Deutsches Bergbau-Museum.



- Hauptmann, A., G. Weisgerber, and H.-G. Bachmann. 1988. "Early Copper Metallurgy in Oman." In *The Beginning of the Use of Metals and Alloys*, edited by R. Maddin, 34-51. Cambridge, MA: The MIT Press.
- Hauptmann, A., F. Begemann, E. Heitkemper, E. Pernicka, and S. Schmitt-Strecker. 1992. "Early Copper Produced at Feinan, Wadi Araba, Jordan: The Composition of Ores and Copper." *Archaeomaterials* 6:1-33.
- Hauptmann, A., R. Maddin, and M. Prange. 2002. "On the Structure and Composition of Copper and Tin Ingots Excavated from the Shipwreck of Uluburun." *BASOR* 328:1-30.
- Hazzidakis, J. 1921. *Tylissos a L'Époque Minoenne*. Paris: Libraire Paul Geuthner.
- Held, S. O. 1993. "Insularity as a Modifier of Cultural Change: The Case of Prehistoric Cyprus." *BASOR* 292:25-34.
- Hellbing, L. 1979. *Alasia Problems*. SIMA LVII. Göteborg, Sweden: Paul Åströms Förlag.
- Heltzer, M. 1977. "The Metal Trade of Ugarit and the Problem of Transportation of Commercial Goods." *Iraq* 39(2):203-11.
- \_\_\_\_\_. 1982. *The Internal Organization of the Kingdom of Ugarit*. Wiesbaden, Germany: Dr. Ludwig Reichert Verlag.
- Herbert, E. W. 1998. "Mining as Microcosm in Precolonial Sub-Saharan Africa." In *Social Approaches to an Industrial Past: The Archaeology and Anthropology of Mining*, edited by A. B. Knapp, V. C. Piggott, and E. W. Herbert, 138-54. London: Routledge.

- Herdits, H. 2003. "Bronze Age Smelting Site in the Mitterberg Mining Area in Austria." In *Mining and Metal Production Through the Ages*, edited by P. T. Craddock and J. Lang, 69-75. London: British Museum Press.
- Hermann, G. 1968. "Lapis Lazuli: The Early Phases of Its Trade." *Iraq* 30:21-57.
- Hestrin, R., and M. Tadmor. 1963. "A Hoard of Tools and Weapons from Kfar Monash." *IEJ* 13(4):265-88.
- Hiller, S. 1991. "The Mycenaeans and the Black Sea." In *Thalassa. L'Egée préhistorique et la mer. Actes de la Troisième Rencontre Egéene Internationale de l'Université de Liège*, edited by R. Laffineur and L. Basch, 207-16. Liège, Belgium: Université de Liège.
- Hirschfield, N. E. 1990. "Incised Marks on Late Helladic and Late Minoan III Pottery." Master's thesis, Texas A&M University.
- \_\_\_\_\_. 2001. "Cypriots to the West? The Evidence of Their Potmarks." In *Italy and Cyprus in Antiquity: 1500-450 BC*, edited by L. Bonfante and V. Karageorghis, 121-30. Nicosia, Cyprus: Costakis and Leto Severis Foundation.
- \_\_\_\_\_. 2002. "Marks on Pots: Patterns of Use in the Archaeological Record at Enkomi." In *Script and Seal Use on Cyprus in the Bronze and Iron Ages*, edited by J. S. Smith, 49-110. Boston, MA: Archaeological Institute of America.
- Höckmann, O. 2003. "Zu Früher Seefahrt in den Meerengen." *Studia Troica* 12:133-60.
- Hoftijzer, J., and W. H. van Soldt. 1998. "Appendix: Texts from Ugarit Pertaining to Seafaring." In *Seagoing Ships and Seamanship in the Bronze Age Levant* by S. Wachsmann, 333-44. College Station: Texas A&M University Press.

- Hood, S. 1987. "Masons' Marks in the Palaces." In *The Function of the Minoan Palaces*, edited by R. Hägg and N. Marinatos, 205-12. Stockholm: Paul Åströms Förlag.
- Hoover, H. C., and L. H. Hoover (trans.). 1950. *De Re Metallica*, by Georgius Agricola. New York: Dover Publications.
- Horne, L. 1982. "Fuel for the Metal Worker: The Role of Charcoal and Charcoal Production in Ancient Metallurgy." *Expedition* 25(1):6-13.
- Hult, G. 1978. *Hala Sultan Tekke 4. Excavations in Area 8 in 1974 and 1975*. SIMA XLV:4. Göteborg, Sweden: Paul Åströms Förlag.
- \_\_\_\_\_ 1981. *Hala Sultan Tekke 7. Excavations in Area 8 in 1977*. SIMA v. XLV:7. Göteborg, Sweden: Paul Åströms Förlag.
- \_\_\_\_\_ 1983. *Bronze Age Ashlar Masonry in the Eastern Mediterranean: Cyprus, Ugarit, and Neighbouring Regions*. SIMA v. LXVI. Göteborg, Sweden: Paul Åströms Förlag.
- Huth, C. 2000. "Metal Circulation, Communication and Traditions of Craftsmanship in Late Bronze Age and Early Iron Age Europe." In *Metals Make the World Go Round: The Supply and Circulation of Metals in Bronze Age Europe. Proceedings of a Conference held at the University of Birmingham in June 1997*, edited by C. F. E. Pare, 176-93. Oxford UK: Oxbow Books.
- Iacovou, M. 1994. "The Topography of 11<sup>th</sup> Century Cyprus." In *Cyprus in the 11<sup>th</sup> Century B.C.*, edited by V. Karageorghis, 149-68. Nicosia, Cyprus: A. G. Leventis Foundation.
- Ilon, G. 1992. "Keftiubarren Ingot from an Urn-Grave Culture Settlement at Górkápolnadomb." In *Acta Archaeologica: Academiae Scientiarum Hungaricae*,

- edited by I. Bana, S. Bökönyi, I. Dienes, L. Gerevich, A. Kubinyi, M. Scabo, I. Torma, 239-59. Budapest, Hungary: Akadémiai Kiadó és Nyomda.
- Jablonka, P., and C. B. Rose. 2004. "Late Bronze Age Troy: A Response to Frank Kolb." *AJA* 108:615-30.
- Janzon, G. O. 1988. "Early Nonferrous Metallurgy in Sweden." In *The Beginning of the Use of Metals and Alloys*, edited by R. Maddin, 104-17. Cambridge, MA: The MIT Press.
- Joel, E. C., K. A. Yener, and E. V. Sayre. 1995. "Comments on 'Oxhide Ingots, Recycling, and the Mediterranean Metals Trade.'" *JMA* 8(1): 45-53.
- Jones, R. E., and L. Vagnetti. 1991. "Traders and Craftsmen in the Central Mediterranean." In *Bronze Age Trade in the Mediterranean*, edited by N. H. Gale, 127-47. SIMA v. XC. Jonsered, Sweden: Paul Åströms Förlag.
- Jovanović, B. 1980. "Primary Copper Mining and the Production of Copper." In *Scientific Studies in Early Mining and Extractive Metallurgy*, edited by P. T. Craddock, 31-40. British Museum Occasional Papers No. 20. London: British Museum.
- \_\_\_\_\_ 1985. "Smelting of Copper in the Eneolithic Period of the Balkans." In *Furnaces and Smelting Technology in Antiquity*, edited by P. T. Craddock and M. J. Hughes, 117-22. British Museum Occasional Paper No. 48. London: British Museum Publishers.
- \_\_\_\_\_ 1988. "Early Metallurgy in Yugoslavia." In *The Beginning of the Use of Metals and Alloys*, edited by R. Maddin, 69-79. Cambridge, MA: The MIT Press.
- Kaptan, E. 1986. "Ancient Mining in the Tokat Province." *Anatolica* 13:19-36.

- \_\_\_\_\_ 1995. "Tin and Ancient Tin Mining in Turkey." *Anatolica* 21:197-203.
- Karageorghis, V. 1973. "A Late Cypriote Hoard of Bronzes from Sinda." *RDAC*:72-82, Pl. VI-VIII.
- \_\_\_\_\_ 1982. "Metallurgy in Cyprus during the 11th Century B.C." In *Early Metallurgy in Cyprus, 4000-500 B.C.*, edited by J. D. Muhly, R. Maddin, and V. Karageorghis, 297-302. Nicosia, Cyprus: Department of Antiquities.
- \_\_\_\_\_ 1994. "The Prehistory of an Ethnogenesis." In *Cyprus in the 11<sup>th</sup> Century B.C.*, edited by V. Karageorghis, 1-10. Nicosia, Cyprus: A. G. Leventis Foundation.
- \_\_\_\_\_ 1999. "Aspects of Trade Between Cyprus and the West During the 14<sup>th</sup>-13<sup>th</sup> Centuries BC." In *The Point Iria Wreck: Interconnections in the Mediterranean ca. 1200 BC*, edited by W. Phelps, Y. Lolos, and Y. Vichos, 121-30. Athens, Greece: Hellenic Institute of Marine Archaeology (HIMA).
- \_\_\_\_\_ 2002. *Early Cyprus*. Los Angeles: J. Paul Getty Museum.
- Karageorghis, V., and M. Demas. 1984. *Pyla-Kokkinokremos: A Late-13<sup>th</sup> Century BC Fortified Settlement in Cyprus*. Nicosia, Cyprus: Chr. Nicolaou & Sons.
- \_\_\_\_\_ 1985. *Excavations at Kition V. The Pre-Phoenician Levels: Areas I and II: Parts 1-2*. Nicosia, Cyprus: Chr. Nicolou & Sons.
- \_\_\_\_\_ 1988. *Excavations at Maa-Palaeokastro 1979-1986*. Nicosia, Cyprus: Chr. Nicolaou & Sons, Ltd.
- Karageorghis, V., and V. Kassianidou. 1999. "Metalworking and Recycling in Late Bronze Age Cyprus—The Evidence from Kition." *OJA* 18(2):171-88.

Karageorghis, V., and G. Pappasavvas. 2001. "A Bronze Ingot-Bearer from Cyprus."

*OJA* 20(4):339-54.

Kassianidou, V. 1994. "Could Iron Have Been Produced in Cyprus?" *RDAC*:73-9.

\_\_\_\_\_. 1999. "Bronze Age Copper Smelting Technology in Cyprus-- The Evidence from Politico *Phorades*." In *Metals in Antiquity*, edited by S. M. M. Young, A. Mark Pollard, P. Budd, and R. A. Ixer, 91-7. BAR-IS 792. Oxford UK: Archaeopress.

\_\_\_\_\_. 2001. "Cypriot Copper to Sardinia. Yet Another Case of Bringing Coals to Newcastle?" In *Italy and Cyprus in Antiquity: 1500-450 BC*, edited by L. Bonfante and V. Karageorghis, 97-120. Nicosia, Cyprus: Costakis and Leto Severis Foundation.

\_\_\_\_\_. 2003. "The Trade of Tin and the Island of Copper." In *The Problem of Early Tin*, edited by A. Giunlia-Mair and F. LoSchiavo, 109-20. BAR-IS 1199. Oxford UK: Archaeopress.

Kassianidou, V., and A. B. Knapp. 2005. "Archaeometallurgy in the Mediterranean: The Social Context of Mining, Metallurgy, and Trade." In *The Archaeology of Mediterranean Prehistory*, edited by E. Blake and A. B. Knapp, 215-51. Malden, MA: Blackwell Publishing.

Kayafa, M., S. Stos-Gale and N. Gale. 2000. "The Circulation of Copper in the Early Bronze Age in Mainland Greece: the Lead Isotope Evidence from Lerna, Lithares and Tsoungiza." In *Metals Make the World Go Round: The Supply and Circulation of Metals in Bronze Age Europe. Proceedings of a Conference held*

- at the University of Birmingham in June 1997*, edited by C. F. E. Pare, 39-55.  
Oxford UK: Oxbow Books.
- Kempinski, A., and S. Košak. 1977. "Metal Inventories (CTH 242) and Their Economic Implications." *Tel Aviv* 4:87-93.
- Keswani, P. S. 1993. "Models of Local Exchange in Late Bronze Age Cyprus." *BASOR* 289:73-83.
- \_\_\_\_\_ 2005. "Death, Prestige, and Copper in Bronze Age Cyprus." *AJA* 109:341-401.
- Keswani, P. S., and A. B. Knapp. 2003. "Bronze Age Boundaries and Social Exchange in North-West Cyprus." *OJA* 22(3):213-23.
- Kitchen, K. A. 1987. "The Basics of Egyptian Chronology in Relation to the Bronze Age." In *High, Middle, or Low? Acts of an International Colloquium on Absolute Chronology held at the University of Gothenberg, 20<sup>th</sup>-22<sup>nd</sup> August 1987*, edited by P. Åström, 37-55. SIMA Pocketbook 57. Jonsered, Sweden: Paul Åströms Förlag.
- \_\_\_\_\_ 1991. "The Chronology of Ancient Egypt." *WorldArch* 23(2):201-8.
- Knapp, A. B. 1986. *Copper Production and Divine Protection: Archaeology, Ideology, and Social Complexity on Bronze Age Cyprus*. Göteborg, Sweden: Paul Åströms Förlag.
- \_\_\_\_\_ 1988. "Hoards D'Oeuvres: Of Metals and Men on Bronze Age Cyprus." *OJA* 7:147-76.
- \_\_\_\_\_ 1990. "Ethnicity, Entrepreneurship, and Exchange: Mediterranean Inter-Island Relations in the Late Bronze Age." *ABSA* 85:115-53.

- \_\_\_\_\_ 1991. "Spice, Drugs, Grain, and Grog: Organic Goods in Bronze Age East Mediterranean Trade." In *Bronze Age Trade in the Mediterranean*, edited by N. H. Gale, 21-68. Jonsered, Sweden: Paul Åströms Förlag.
- \_\_\_\_\_ 1993. "Social Complexity: Incipience, Emergence, and Development on Prehistoric Cyprus." *BASOR* 292: 85-106.
- \_\_\_\_\_ 1997. *The Archaeology of Late Bronze Age Cypriot Society: The Study of Settlement, Survey, and Landscape*. Glasgow, England: University of Glasgow.
- \_\_\_\_\_ 1999. "The Archaeology of Mining: Fieldwork Perspectives from the Sydney Cyprus Survey Project (SCSP)." In *Metals in Antiquity*, edited by S. M. M. Young, A. Mark Pollard, P. Budd, and R. A. Ixer, 98-109. BAR-IS 792. Oxford UK: Archaeopress.
- \_\_\_\_\_ 2002. "Excavations at Politiko *Phorades*: a Bronze Age Copper Smelting Site on Cyprus." *Antiquity* 76:319-20.
- \_\_\_\_\_ 2003. "The Archaeology of Community on Bronze Age Cyprus: Politiko *Phorades* in Context." *AJA* 107:559-80.
- Knapp, A. B., and J. Cherry. 1994. *Provenience Studies and Bronze Age Cyprus: Production, Exchange, and Politico-Economic Change*. Monographs in World Archaeology No. 21. Madison, WI: Prehistory Press.
- Knapp, A. B., J. D. Muhly, and P. M. Muhly. 1988. "To Hoard is Human: Late Bronze Age Metal Deposits in Cyprus and the Aegean." *RDAC*:233-62.
- Knapp, A. B., M. Donnelly, and V. Kassianidou. 1998. "Excavations at Politiko *Phorades*, 1997." *RDAC*:247-68.



- Knapp, A. B., V. Kassianidou, and M. Donnelly. 1999. "Excavations at Politiko Phorades, 1998." *RDAC*:125-46.
- Kolb, F. 2004. "Troy VI: A Trading Center and Commercial City?" *AJA* 108:577-614.
- Koucky, F., and A. Steinberg. 1982a. "The Ancient Slags of Cyprus." In *Early Metallurgy in Cyprus, 4000-500 B.C.*, edited by J. D. Muhly, R. Maddin, and V. Karageorghis, 117-142. Nicosia, Cyprus: Department of Antiquities.
- \_\_\_\_\_ 1982b. "Ancient Mining and Mineral Dressing on Cyprus." In *The Evolution of the First Fire-Using Industries*, edited by T. A. Wertime and S. F. Wertime, 149-80. Washington D. C.: Smithsonian Institution Press.
- Lagarce, J. 1986. "Herstellung von Kupferrohbarren in Ras Ibn Hani [Syrien]. *Acta Praehistorica et Archaeologica* 18:85-90.
- Lagarce, J., and E. Lagarce. 1996. "Les Lingots 'En Peau de Boeuf', Objets de Commerce et Symbols Idéologiques dans le Monde Méditerranéen." *Revue des Études Phenico-Puniques et d'Antiquites Libyennes*, 2-19, Figures 2, 11.
- Lagarce, J., É. Lagarce, A. Bounni, and N. Saliby. 1983. "Les Fouilles à Ras Ibn Hani en Syrie (Campagnes de 1980, 1981, et 1982). Contribution à L'Étude de Quelques Aspects de la Civilisation Ugaritique." *CRAI* 74:249-90.
- Lambert, W. G. 1991. "Metalworking and its Patron Deities in the Early Levant." *Levant* XXIII:183-6.
- Larsen, M. T. 1976. *The Old Assyrian City-State and Its Colonies*. Copenhagen Studies in Assyriology Volume 4. Copenhagen, Denmark: Akademisk Forlag.
- \_\_\_\_\_ 1977. "Partnerships in Old Assyrian Trade." *Iraq* 39(1):119-45.

- Lassen, H. 2000. "Introduction to Weight Systems in the Bronze Age East Mediterranean: the Case of Kalavassos-Ayios Dhimitrios." In *Metals Make the World Go Round: The Supply and Circulation of Metals in Bronze Age Europe. Proceedings of a Conference held at the University of Birmingham in June 1997*, edited by C. F. E. Pare, 233-46. Oxford UK: Oxbow Books.
- Leemans, W. F. 1950. *The Old Babylonian Merchant: His Business and Social Position*. Leiden, Holland: E. J. Brill.
- \_\_\_\_\_ 1960. *Foreign Trade in the Old Babylonian Period, as Revealed by Texts from Southern Mesopotamia*. Leiden, Holland: E. J. Brill.
- Levy, T. E., and S. Shalev. 1989. "Prehistoric Metalworking in the Southern Levant: Archaeometallurgical and Social Perspectives." *WorldArch* 20(3):352-72.
- Levy, T. E., R. B. Adams, and M. Najjar. 1999. "Early Metallurgy and Social Evolution: Jabal Hamrat Fidan." *ACOR Newsletter* 11(1):1-3.
- Levy, T. E., R. B. Adams, A. J. Witten, J. Anderson, Y. Arbel, S. Kuah, J. Moreno, A. Lo, and M. Wagonner. 2001. "Early Metallurgy, Interaction, and Social Change: The Jabal Hamrat Fīdān (Jordan) Research Design and 1998 Archaeological Survey: Preliminary Report." *ADAJ* 45:159-87.
- Levy, T. E., R. B. Adams, A. Hauptmann, M. Prange, S. Schmitt-Strecker, and M. Najjar. 2002. "Early Bronze Age Metallurgy: a Newly Discovered Copper Manufactory in Southern Jordan." *Antiquity* 76:425-37.
- Lichardus, J., R. Echt, I. K. Iliev, and C. J. Christou. 2002. "Die Spätbronzezeit an der Unteren Tundža und die Ostägäischen Verbindungen in Südostbulgarien." *Eurasia Antiqua* 8:135-84.

- Lin, S-H. S. 2003. "Lading of the Late Bronze Age Ship at Uluburun." Masters' thesis, Texas A&M University.
- Linder, E. 1972. "A Seafaring Merchant-Smith from Ugarit and the Cape Gelidonya wreck." *IJNA* 1:163-4.
- \_\_\_\_\_ "Ugarit: A Canaanite Thalassocracy." In *Ugarit in Retrospect: Fifty Years of Ugarit and Ugaritic*, edited by G. D. Young, 31-42. Winona Lake, IN: Eisenbrauns.
- Lipiński, E. 1977. "An Ugaritic Letter to Amenophis III Concerning the Trade with Alašiya." *Iraq* 39:213-7.
- Liverani, M. 1979, "'Irrational' Elements in the Amarna Trade." In *Three Amarna Essays*, p. 93-106. Translated by M. L. Jaffe. Monographs on the Ancient Near East [MANE] vol. 1, fascicle 5, p. 93-106. Malibu, CA: Undena Publications.
- \_\_\_\_\_ 1987. "The Collapse of the Near Eastern Regional System at the End of the Bronze Age: the Case of Syria." In *Centre and Periphery in the Ancient World*, edited by M. Rowlands, M. Larsen, and K. Kristiansen, 66-73. Cambridge, UK: Cambridge University Press.
- \_\_\_\_\_ 2000. "The Great Powers Club." In *Amarna Diplomacy*, edited by R. Cohen and R. Westbrook, 15-27. Baltimore: Johns Hopkins University Press.
- van Lokeren, S. 2000. "Experimental Reconstruction of the Casting of Copper Oxhide Ingots." *Antiquity* 74:275-6.
- Lolos, Y. G. 1999. "The Cargo of Pottery from the Point Iria Wreck: Character and Implications." In *The Point Iria Wreck: Interconnections in the Mediterranean*

*ca. 1200 BC*, edited by W. Phelps, Y. Lolos, and Y. Vichos, 43-58. Athens, Greece: Hellenic Institute of Marine Archaeology (HIMA).

LoSchiavo, F. 1982. "Copper Metallurgy in Sardinia During the Late Bronze Age: New Prospects on its Aegean Connections." In *Early Metallurgy in Cyprus, 4000-500 B.C.*, edited by J. D. Muhly, R. Maddin, and V. Karageorghis, 271-84. Nicosia, Cyprus: Department of Antiquities.

\_\_\_\_\_ 1986. "Sardinian Metallurgy: The Archaeological Background." In *Studies in Sardinian Archaeology, Volume II: Sardinia in the Mediterranean*, edited by M. S. Balmuth, 231-50. Ann Arbor, MI: University of Michigan Press.

\_\_\_\_\_ 1988. "Early Metallurgy in Sardinia." In *The Beginning of the Use of Metals and Alloys*, edited by R. Maddin, 92-103. Cambridge, MA: The MIT Press.

\_\_\_\_\_ 1989. "Early Metallurgy in Sardinia. Copper Oxhide Ingots." In *Old World Archaeometallurgy*, edited by A. Hauptmann, E. Pernicka, and G. A. Wagner, 33-8. Bochum, Germany: Selbstverlag des Deutschen Bergbau-Museums.

\_\_\_\_\_ 1995. "Cyprus and Sardinia in the Mediterranean: Trade Routes Toward the West." In *Cyprus and the Sea*, edited by V. Karageorghis and D. Michaelides, 45-60. Nicosia: University of Cyprus.

\_\_\_\_\_ 1998. "Sardinian Oxhide Ingots 1998." In *Metallurgica Antiqua: In honour of Hans-Gert Bachmann and Robert Maddin*, edited by Th. Rehren, A. Hauptmann, and J. D. Muhly, 99-112. Der Anschnitt, Beiheft 8. Bochum, Germany: Selbstverlag des Deutschen Bergbau Museum.

- \_\_\_\_\_ 2001. "Late Cypriot Bronzework and Bronzeworkers in Sardinia, Italy, and Elsewhere in the West." In *Italy and Cyprus in Antiquity: 1500-450 BC*, edited by L. Bonfante and V. Karageorghis, 131-52. Nicosia, Cyprus: Costakis and Leto Severis Foundation.
- \_\_\_\_\_ 2003. "The Problem of Early Tin from the Point of View of Nuragic Sardinia." In *The Problem of Early Tin*, edited by A. Giumlia-Mair and F. LoSchiavo, 121-32. BAR-IS 1199. Oxford UK: Archaeopress.
- \_\_\_\_\_ 2005. "Metallhandel im zentralen Mittelmeer." In *Das Schiff von Uluburun. Welthandel vor 3000 Jahren*, edited by Yalçın, Ü., C. Pulak, and R. Slotta, 399-414. Bochum, Germany: Deutsches Bergbau-Museum.
- LoSchiavo, F., E. MacNamara, and L. Vagnetti. 1985. "Late Cypriot Imports to Italy and their Influence on Local Bronzework." *Papers of the British School at Rome* LIII, 1-71.
- LoSchiavo, F., T. Stech, R. Maddin, and J. Muhly. 1987. "Ingots and Artifacts from Nuragic Contexts in Sardinia." In *Studies in Sardinian Archaeology III: Nuragic Sardinia and the Mycenaean World*, edited by M. S. Balmuth, 179-88. BAR-IS 387. Oxford UK: British Archaeological Reports.
- LoSchiavo, F., R. Maddin, J. Merkel, J. D. Muhly, and T. Stech. 1990. *Metallographic and Statistical Analyses of Copper Ingots from Sardinia*. Ozieri: Il Torchietto.
- Lucas, A., and J. R. Harris. 1999. Reprint. *Ancient Egyptian Materials and Industries*. Mineola, New York: Dover Publications, Inc. Original edition, London: Edward Arnold Publishers Ltd, 1962.

- MacNamara, E., and N. Meeks. 1986. "The Metallurgical Examination of Four Late Cypriot III Stands Now in the British Museum." *RDAC*:57-62, Pl. XVII-XVIII.
- Maddin, R. 1982. "Early Iron Technology in Cyprus." In *Early Metallurgy in Cyprus, 4000-500 B.C.*, edited by J. D. Muhly, R. Maddin, and V. Karageorghis, 303-14. Nicosia, Cyprus: Department of Antiquities.
- \_\_\_\_\_. 1988. "Technical Studies—Early Use of Metals." In *Material Issues in Art and Archaeology*, edited by E. V. Sayre, P. B. Vandiver, J. Druzik, and C. Stevenson, 171-81. Materials Research Society Symposium Proceedings, v. 123. Pittsburgh, PA: Materials Research Society.
- \_\_\_\_\_. 1989. "The Copper and Tin Ingots from the Kaş Shipwreck." In *Old World Archaeometallurgy*, edited by A. Hauptmann, E. Pernicka, and G. A. Wagner, 99-106. Bochum, Germany: Selbstverlag des Deutschen Bergbau-Museums.
- Maddin, R., and T. Stech-Wheeler. 1976. "Metallurgical Study of Seven Bar Ingots." *IEJ* 26: 170-3.
- Maddin, R., T. Stech Wheeler, and J. D. Muhly. 1977. "Tin in the Ancient Near East: Old Questions and New Finds." *Expedition* 19(2):35-47.
- Maddin, R., J. D. Muhly, and T. S. Wheeler. 1983. "Metalworking." In *Excavations at Atheniou, Cyprus, 1971-1972*, edited by T. Dothan and A. Ben-Tor, 132-8. Qedem Monographs of the Institute of Archaeology, Hebrew University, Jerusalem. Jerusalem: Hebrew University.
- Maggi, R., and M. Pearce. 2005. "Mid Fourth-Millennium Copper Mining in Liguria, North-west Italy: the Earliest Known Copper Mines in Western Europe." *Antiquity* 79:66-77.

- Malamat, A. 1971. "Syro-Palestinian Destinations in a Mari Tin Inventory." *IEJ* 21:31-8.
- Malinowski, B. 1950. *Argonauts of the Western Pacific*. New York: E. P. Dutton & Co., Inc.
- Mallowan, M. E. L. 1966. *Nimrud and Its Remains*, v. 1-2. New York: Dodd, Mead & Company.
- Mangou, H., and P. V. Ioannou. 2000. "Studies of the Late Bronze Age Copper-based Ingots found in Greece." *ABSA* 95:207-17.
- Manning, S. W. 1993. "Prestige, Distinction, and Competition: The Anatomy of Socioeconomic Complexity on in Fourth-Millennium BCE Cyprus." *BASOR* 292:35-58.
- Maraszek, R. 2000. "Late Bronze Age Axe Hoards in Western and Northern Europe." In *Metals Make the World Go Round: The Supply and Circulation of Metals in Bronze Age Europe. Proceedings of a Conference held at the University of Birmingham in June 1997*, edited by C. F. E. Pare, 209-24. Oxford UK: Oxbow Books.
- de Maret, P. 1995. "Croisette Histories." In *Objects: Signs of Africa*, edited by L. de Heusch, 133-45. Belgium: Snoeck-Ducaju & Zoon.
- Margariti, R. E. 1998. "The Şeytan Deresi Wreck and the Minoan Connection in the Eastern Aegean." Master's thesis, Texas A&M University.
- Marshall, P. D., S. L. O'Hara, and B. S. Ottaway. 1999. "Early Copper Metallurgy in Austria and Methods of Assessing the Impact on the Environment." In *The Beginnings of Metallurgy: Proceedings of the International Conference 'The*

- Beginnings of Metallurgy', Bochum 1995*, edited by A. Hauptmann, E. Pernicka, T. Rehren, and Ü. Yalçın, 255-66. Bochum, Germany: Bergbau-Museum.
- Massoli-Novelli, R. 1986. "The Geology, Environment, and Natural Resources of Sardinia." In *Studies in Sardinian Archaeology, Volume II: Sardinia in the Mediterranean*, edited by M. S. Balmuth, 3-8. Ann Arbor, MI: University of Michigan Press.
- Masson, E. 1972. "Quelques Inscriptions Chypro-Minoennes du Nord-Ouest de Chypre." *RDAC*:129-33, Pl. XX-XI. Nicosia, Cyprus: Zavallis Press Ltd.
- Matthäus, H. 1985. *Metallgefäße und Gefäßuntersätze der Bronzezeit, der geometrischen und archaischen Periode auf Cypern*. Prähistorische Bronzefunde Abteilung II, Band 8. München, Germany: C. H. Beck'sche Verlagsbuchhandlung.
- \_\_\_\_\_. 2005. "Kulturaustausch, Handel, und Seefahrt im Mittelmeerraum während der Späten Bronzezeit." In *Das Schiff von Uluburun. Welthandel vor 3000 Jahren*, edited by Yalçın, Ü., C. Pulak, and R. Slotta, 333-66. Bochum, Germany: Deutsches Bergbau-Museum.
- McGeehan Liritzis, V. 1996. *The Role and Development of Metallurgy in the Late Neolithic and Early Bronze Age of Greece*. Jonsered: Paul Åströms Förlag.
- McKerrell, H. 1978. "The Use of Tin-Bronze in Britain and the Comparative Relationship with the Near East." In *The Search for Ancient Tin*, edited by D. A. Franklin, J. S. Olin, and T. A. Wertime, 7-23. Washington D.C.: U. S. Government Printing Office.



- Mee, C. 1998. "Anatolia and the Aegean in the Late Bronze Age." In *Aegeum 18: The Aegean and the Orient in the Second Millennium*, edited by E. H. Cline and D. Harris-Cline, 137-48, Pl. XIII. Eupen, Belgium: Kliemo SA.
- Meiggs, R. 1982. *Trees and Timber in the Ancient World*. Oxford UK: Clarendon Press.
- Mellink, M. J. 1983. "The Hittites and the Aegean World: Part 2. Archaeological Comments on Ahhiyawa-Achaians in Western Anatolia." *AJA* 87:138-43.
- Merkel, J. 1983. "Summary of Experimental Results for Late Bronze Age Copper Smelting and Refining." *MASCA Journal* 2(6):173-8.
- \_\_\_\_\_ 1986a. "Ancient Smelting and Casting of Copper 'Oxhide' Ingots." In *Studies in Sardinian Archaeology, Volume II: Sardinia in the Mediterranean*, edited by M. S. Balmuth, 251-64. Ann Arbor: University of Michigan Press.
- \_\_\_\_\_ 1986b. "Colloquial Discussion on Copper 'Oxhide' Ingots." In *Studies in Sardinian Archaeology, Volume II: Sardinia in the Mediterranean*, edited by M. S. Balmuth, 265-72. Ann Arbor: University of Michigan Press.
- Merkel, J., and B. Rothenberg. 1999. "The Earliest Steps to Copper Metallurgy in the Western Arabah." In *The Beginnings of Metallurgy: Proceedings of the International Conference 'The Beginnings of Metallurgy', Bochum 1995*, edited by A. Hauptmann, E. Pernicka, T. Rehren, and Ü. Yalçin, 149-66. Bochum, Germany: Bergbau-Museum.
- Merrillees, R. S. 1968. *The Cypriote Bronze Age Pottery Found in Egypt*. SIMA v. XVIII. Lund, Sweden: Paul Åströms Förlag.
- \_\_\_\_\_ 1984. "Ambelikou-Aletri: A Preliminary Report." *RDAC*:1-13.
- \_\_\_\_\_ 1987. *Alashia Revisited*. Paris: J. Gabalda et Cie.

- Meyer, C. 1998. "Gold-Miners and Mining at Bir Umm Fawakhir." In *Social Approaches to an Industrial Past: The Archaeology and Anthropology of Mining*, edited by A. B. Knapp, V. C. Piggott, and E. W. Herbert, 123-38. London: Routledge.
- Mighall, T. M. 2003. "Geochemical Monitoring of Heavy Metal Pollution and Prehistoric Mining: Evidence from Copa Hill, Cwmystwyth, and Mount Gabriel, County Cork." In *Mining and Metal Production Through the Ages*, edited by P. T. Craddock and J. Lang, 43-51. London: British Museum Press.
- Millard, A. R. 1973. "Cypriot Copper in Babylonia, c. 1745 BC." *JCS* 25:211-4.
- Misch-Brandl, O., E. Galili, and S. Wachsmann. 1985. "Finds from the Late Canaanite (Bronze) Period, 14<sup>th</sup>-13<sup>th</sup> Century BCE." In *From the Depths of the Sea: Cargoes of Ancient Wrecks from the Carmel Coast. (The Israel Museum Catalogue No. 263)*, edited by O. Misch-Brandl, 7-11. Jerusalem: The Israel Museum.
- Moran, W. L. (ed. and trans.). 1992. *The Amarna Letters*. Baltimore: Johns Hopkins University Press.
- Moorey, P. R. S. 1988a. "The Chalcolithic Hoard from Nahal Mishmar, Israel, in Context." *WorldArch* 20(2):171-89.
- \_\_\_\_\_ 1988b. "Early Metallurgy in Mesopotamia." In *The Beginning of the Use of Metals and Alloys*, edited by R. Maddin, 28-33. Cambridge, MA: The MIT Press.
- \_\_\_\_\_ 1994. *Ancient Mesopotamian Materials and Industries*. Oxford UK: Clarendon Press.

- Muhly, J. D. 1973a. *Copper and Tin: The Distribution of Mineral Resources and the Nature of the Metals Trade in the Bronze Age*. Transactions of the Connecticut Academy of Arts and Sciences, v. 43, 155-535. Hamden, CT: Archon Books.
- \_\_\_\_\_ 1973b. "Tin Trade Routes of the Bronze Age." *American Scientist* 61:404-13.
- \_\_\_\_\_ 1977. "The Copper Oxhide Ingot and the Bronze Age Metals Trade." *Iraq* 39:73-82.
- \_\_\_\_\_ 1978. "New Evidence for Sources of and Trade in Bronze Age Tin." In *The Search for Ancient Tin*, edited by A. D. Franklin, J. S. Olin, and T. A. Wertime, 43-9. Washington: U. S. Government Printing Office.
- \_\_\_\_\_ 1979. "Cypriote Copper: Some Geological and Metallurgical Problems." In *Acts of the International Archaeological Symposium: "The Relations Between Cyprus and Crete, ca. 2000-500 B.C."*, 87-100. Nicosia, Cyprus: Chr. Nicolaou & Sons, Ltd.
- \_\_\_\_\_ 1980a. "The Bronze Age Setting." In *The Coming of the Age of Iron*, 25-68. New Haven: Yale University Press.
- \_\_\_\_\_ 1980b. "Bronze Figurines and Near Eastern Metalwork." *IEJ* 30:148-61.
- \_\_\_\_\_ 1982. "The Nature of Trade in the LBA East Mediterranean: The Organization of the Metals' Trade and the Role of Cyprus." In *Early Metallurgy in Cyprus, 4000-500 B.C.*, edited by J. D. Muhly, R. Maddin, and V. Karageorghis, 251-70. Nicosia, Cyprus: Department of Antiquities.
- \_\_\_\_\_ 1985a. "Beyond Typology: Aegean Metallurgy in its Historical Context." In *Contributions to Aegean Archaeology: Studies in Honor of William A.*

*McDonald*, edited by N. C. Wilkie and W. D. E. Coulson, 109-42. Minneapolis: The Center for Ancient Studies, University of Minnesota.

\_\_\_\_\_ 1985b. "The Late Bronze Age in Cyprus: A 25 Year Retrospect." In *Archaeology in Cyprus 1960-1985*, edited by V. Karageorghis, 20-46. Nicosia, Cyprus: Zavallis Press Ltd.

\_\_\_\_\_ 1985c. "Sources of Tin and the Beginnings of Bronze Metallurgy." *AJA* 89:275-91.

\_\_\_\_\_ 1985d. "Lead Isotope Analysis and the Problem of Lead in Cyprus." *RDAC*:78-82.

\_\_\_\_\_ 1987. "Book Review: R. D. Penhallurick, *Tin in Antiquity, its Mining and Trade Throughout the Ancient World with Particular Reference to Cornwall.*" *Archaeomaterials* 2, p. 99-106.

\_\_\_\_\_ 1988. "The Beginnings of Metallurgy in the Old World." In *The Beginning of the Use of Metals and Alloys*, edited by R. Maddin, 2-20. Cambridge, MA: The MIT Press.

\_\_\_\_\_ 1989. "The Organisation of the Copper Industry in Late Bronze Age Cyprus." In *Early Society in Cyprus*, edited by E. Peltenburg, 298-314. Edinburgh, Scotland: Edinburgh University Press.

\_\_\_\_\_ 1991. "The Development of Copper Metallurgy in Late Bronze Age Cyprus." In *Bronze Age Trade in the Mediterranean*, edited by N. H. Gale, 180-97. SIMA v. XC. Jonsered, Sweden: Paul Åströms Förlag.

\_\_\_\_\_ 1993. "Early Bronze Age Tin and the Taurus." *AJA* 97:239-53.

\_\_\_\_\_ 1995. "Lead Isotope Analysis and the Archaeologist." *JMA* 8(1):54-8.

- \_\_\_\_\_ 1996. "The Significance of Metals in the Late Bronze Age Economy of Cyprus." In *The Development of the Cypriot Economy*, edited by V. Karageorghis and D. Michaelides, 45-59. Nicosia, Cyprus: Lithographica.
- \_\_\_\_\_ 1999. "Copper and Bronze in Cyprus and the Eastern Mediterranean." In *Archaeometallurgy of the Asian Old World*, edited by V. C. Piggott. MASCA Research Papers in Science and Archaeology, Volume 16, 15-25. The University Museum, University of Pennsylvania.
- \_\_\_\_\_ 2004. "Chrysokamino and the Beginnings of Metal Technology on Crete and the Aegean." In *Crete Beyond the Palaces: Proceedings of the Crete 2000 Conference*, edited by L. P. Day, M. S. Mook, and J. D. Muhly, 283-9. Prehistory Monographs 10. Philadelphia, PA: INSTAP Academic Press.
- \_\_\_\_\_ 2005. "Kupfer und Bronze in der spätbronzezeitlichen Ägäis." In *Das Schiff von Uluburun. Welthandel vor 3000 Jahren. Katalog der Ausstellung des Deutschen Bergbau-Museums Bochum vom 15. Juli 2005 bis 16. Juli 2006*, edited by Yalçın, Ü., C. Pulak, and R. Slotta, 503-13. Bochum, Germany: Deutsches Bergbau-Museum.
- Muhly, J. D., and R. Maddin. 1988. "Appendix XII. Report on the Analysis of Fragment of Copper Oxide Ingot (No. 189) from Maa-Palaeokastro." In *Excavations at Maa-Palaeokastro, 1979-1986*, by V. Karageorghis and M. Demas, 471-2, Pl. A. Nicosia, Cyprus: Department of Antiquities.
- Muhly, J. D., T. Stech-Wheeler, and R. Maddin. 1977. "The Cape Gelidonya Shipwreck and the Bronze Age Metals Trade in the Eastern Mediterranean." *JFA* 4:353-62.

- Muhly, J. D., R. Maddin, and T. S. Wheeler. 1980. "The Oxhide Ingots from Enkomi and Mathiati and Late Bronze Age Copper Smelting in Cyprus." *RDAC*:84-95.
- Müller-Karpe, A. 2005. "Metallbarren bei den Hethitern." In *Das Schiff von Uluburun. Welthandel vor 3000 Jahren. Katalog der Ausstellung des Deutschen Bergbau-Museums Bochum vom 15. Juli 2005 bis 16. Juli 2006*, edited by Yalçın, Ü., C. Pulak, and R. Slotta, 485-492. Bochum, Germany: Deutsches Bergbau-Museum.
- Mumford, G. 2006. "Tell Ras Budran (Site 345): Defining Egypt's Eastern Frontier and Mining Operations in South Sinai During the Late Old Kingdom (Early EB IV/MB I)." *BASOR* 342:13-67.
- Mumford, G., and S. Parcak. 2003. "Pharaonic Ventures into South Sinai: El-Markha Plain Site 346." *JEA* 89:85-116.
- Mylonas, G. E. 1962. "Three Late Mycenaean Knives." *AJA* 66:406-8, Pl. 121.
- Negbi, O. 1976. *Canaanite Gods in Metal*. Tel Aviv: Tel Aviv University Institute of Archaeology.
- \_\_\_\_\_ 1986. "The Climax of Urban Development in Bronze Age Cyprus." *RDAC*:97-121.
- \_\_\_\_\_ 2005. "Urbanism in Late Bronze Age Cyprus: LC II in Retrospect." *BASOR* 337:1-45.
- Nibbi, Alessandra. 1987. *Ancient Egyptian Pot Bellows and the Oxhide Ingot Shape*. Oxford UK: DE Publications.
- Niemeier, W.-D. 1998. "The Mycenaean in Western Anatolia and the Problem of the Origins of the Sea Peoples." In *Mediterranean Peoples in Transition, Thirteenth*

- to *Early Tenth Centuries BCE*, edited by S. Gitin, A. Mazar, and E. Stern, 17-65. Jerusalem: Israel Exploration Society.
- \_\_\_\_\_ 1999. "Mycenaeans and Hittites in War in Western Asia Minor." In *Aegeum 19: Polemos Le Contexte Guerrier en Egee A L'Age du Bronze*, edited by R. Laffineur, 141-56. Eupen, Belgium: Kliemo SA.
- Northover, P., and C. Gillis. 1999. Questions in the Analysis of Ancient Tin." In *Metals in Antiquity*, edited by S. M. M. Young, A. M. Pollard, P. Budd and R. A. Ixer, 78-85. BAR-IS 792. Oxford UK: Archaeopress.
- Öbrink, U. 1979a. *Hala Sultan Tekke 5. Excavations in Area 22, 1971-1973 and 1975-1978*. SIMA v. XLV:5. Göteborg, Sweden: Paul Åströms Förlag.
- \_\_\_\_\_ 1979b. *Hala Sultan Tekke 6. A Sherd Deposit in Area 22*. SIMA v. XLV:6. Göteborg, Sweden: Paul Åströms Förlag.
- O'Connor, D. 1967. "Appendix 8: Model Ingots in Egyptian Foundation Deposits." In *Cape Gelidonya: A Bronze Age Shipwreck* by G. F. Bass, 172-4. Transactions of the American Philosophical Society, v. 57, pt. 8. Philadelphia, PA: The American Philosophical Society.
- Ogden, J. 2000. "Metals." In *Ancient Egyptian Materials and Technology*, edited by P. T. Nicholson and I. Shaw, 148-76. Cambridge, UK: Cambridge University Press.
- Panagiotopoulos, D. 2001. "Keftiu in Context: Theban Tomb-Paintings as a Historical Source." *OJA* 20(3):263-83.
- Papadopoulos, T. J., and L. Kontorli-Papadopoulou. 2000. "Four Late Bronze Age Italian Imports in Achaea." In *Periplus: Festschrift für Hans-Günther Buchholz*

- zu seinem achtzigsten Geburtstag am 24. Dezember 1999, edited by P. Åström and D. Sörenhagen, 143-6. Jonsered, Sweden: Paul Åströms Förlag.
- Parker, A. J. 1992. *Ancient Shipwrecks of the Mediterranean and the Roman Provinces*. BAR-IS 580. Oxford UK: Hadrian Books.
- Pearce, M. 2000. "Metals Make the World Go Round: the Copper Supply for Frattesina." In *Metals Make the World Go Round: The Supply and Circulation of Metals in Bronze Age Europe. Proceedings of a Conference held at the University of Birmingham in June 1997*, edited by C. F. E. Pare, 108-15. Oxford UK: Oxbow Books.
- Peltenburg, E. J. 1982. "Early Copperwork and the Exploitation of Picrolite: Evidence from the Lemba Archaeological Project." In *Early Metallurgy in Cyprus, 4000-500 B.C.*, edited by J. D. Muhly, R. Maddin, and V. Karageorghis, 41-62. Nicosia, Cyprus: Department of Antiquities.
- Penhallurick, R. D. 1986. *Tin in Antiquity*. London: The Institute of Metals.
- Pernicka, E. 1995. "Crisis or Catharsis in Lead Isotope Analysis?" *JMA* 8(1):59-64.
- \_\_\_\_\_ 1999. "Trace Element Fingerprinting of Ancient Copper: A Guide to Technology or Provenance?" In *Metals in Antiquity*, edited by S. M. M. Young, A. Mark Pollard, P. Budd, and R. A. Ixer, 110-21. BAR-IS 792. Oxford UK: Archaeopress.
- Pernicka, E., G. A. Wagner, J. D. Muhly, and Ö. Öztunali. 1992. "Comment on the Discussion of 'Ancient Tin Sources in Anatolia.'" *JMA* 5(1):91-8.
- Petrie, W. M. F. 1906. *Researches in Sinai*. New York: E. P. Dutton and Company.
- \_\_\_\_\_ 1934. *Measures and Weights*. London: Methuen & Co., Ltd.



- Petruso, K. M. 1984. "Prolegomena to Late Cypriot Weight Metrology." *AJA* 88:293-304.
- \_\_\_\_\_. 1992. *Keos* Vol. 8, VIII. *Ayia Irini: The Balance Weights*. Mainz on Rhine, Germany: Verlag Philipp von Zabern.
- Philip, G. 1991. "Cypriot Bronzework in the Levantine World: Conservatism, Innovation, and Social Change." *JMA* 4(1):59-108.
- Pickles, S., and E. Peltenburg. 1998. "Metallurgy, Society, and the Bronze/Iron Age Transition in the East Mediterranean and the Near East." *RDAC*:67-100.
- Piggott, V. C. 1999. "The Archaeometallurgy of the Asian Old World: Introductory Comments." In *Archaeometallurgy of the Asian Old World*, edited by V. C. Piggott. MASCA Research Papers in Science and Archaeology, Volume 16, 1-13. The University Museum, University of Pennsylvania.
- Platon, N. 1971. *Zakros: The Discovery of a Lost Palace of Ancient Crete*. New York: Charles Scribners' Sons.
- Pomerance, L. 1975. "The Possible Role of Tomb Robbers and Viziers of the 18<sup>th</sup> Dynasty in Confusing Minoan Chronology." In *Studi in Onore di Professor Doro Levi. Antichità Cretesi I*, 21-30, pl. IV-V. Roma: Università di Cantania, Institutodi Archeologica.
- Porada, E. 1981. "The Cylinder Seals Found at Thebes in Boeotia." *Archiv für Orientforschung* XXVIII:1-77.
- Prange, M. K., H.-J. Götze, A. Hauptmann, and G. Weisgerber. 1999. "Is Oman the Ancient Magan? Analytical Studies of Copper from Oman." In *Metals in*

- Antiquity*, edited by S. M. M. Young, A. M. Pollard, P. Budd and R. A. Ixer, 187-92. BAR-IS 792. Oxford UK: Archaeopress.
- Primas, M. 2003. "The Use of Tin and Lead in Late Bronze Age Metallurgy." In *The Problem of Early Tin*, edited by A. Giumlia-Mair and F. LoSchiavo, 87-92. BAR-IS 1199. Oxford UK: Archaeopress.
- \_\_\_\_\_. 2005. "Ochsenhautbarren in Europa." In *Das Schiff von Uluburun. Welthandel vor 3000 Jahren. Katalog der Ausstellung des Deutschen Bergbaumuseums Bochum vom 15. Juli 2005 bis 16. Juli 2006*, edited by Yalçın, Ü., C. Pulak, and R. Slotta, p. 385-391. Bochum, Germany: Deutsches Bergbaumuseum.
- Primas, M., and E. Pernicka. 1998. "Neue Ergebnisse zur Zirkulation von Metallbarren." *Germania* 76:25-65.
- Pritchard, J. B. (ed.). 1950. *Ancient Near Eastern Texts Relating to the Old Testament*. Princeton, NJ: Princeton University Press.
- Pulak, C. 1987. "A Late Bronze Age Shipwreck at Ulu Burun: Preliminary Analysis (1984-1985 Excavation Campaigns)." Master's thesis, Texas A&M University.
- \_\_\_\_\_. 1997. "The Uluburun Shipwreck." In *Res Maritimae: Cyprus and the Eastern Mediterranean from Prehistory to Late Antiquity*. Cyprus American Research Institute Monograph Series, v.1, 233-62. Atlanta: Scholars' Press.
- \_\_\_\_\_. 1998. "The Uluburun shipwreck: an overview." *IJNA* 27(3):188-224.
- \_\_\_\_\_. 1999. "A Late Bronze Age Shipwreck at Uluburun: Aspects of Hull Construction." In *The Point Iria Wreck: Interconnections in the Mediterranean*

ca. 1200 B.C., edited by W. Phelps, Y. Lolos, and Y. Vichos, 209-38. Athens, Greece: Hellenic Institute of Marine Archaeology (HIMA).

\_\_\_\_\_ 2000a. "The Copper and Tin Ingots from the Late Bronze Age Shipwreck at Uluburun." *Der Anschnitt* 13:137-57.

\_\_\_\_\_ 2000b. "The Balance Weights from the Late Bronze Age Shipwreck at Uluburun." In *Metals Make the World Go Round: The Supply and Circulation of Metals in Bronze Age Europe. Proceedings of a Conference held at the University of Birmingham in June 1997*, edited by C. F. E. Pare, 247-66. Oxford UK: Oxbow Books.

\_\_\_\_\_ 2001. "The Cargo of the Uluburun Ship and Evidence for Trade with the Aegean and Beyond." From *Italy and Cyprus in Antiquity: 1500-450 BC*, edited by L. Bonfante and V. Karageorghis, 13-60. Nicosia, Cyprus: Costakis and Leto Severis Foundation.

\_\_\_\_\_ 2005. "Who Were the Mycenaeans Aboard the Uluburun Ship?" In *Emporia: Aegeans in the Central and Eastern Mediterranean (Aegeum 25)*, edited by R. Laffineur and E. Greco, 295-310, Pl. LXX-I. Proceedings of the 10<sup>th</sup> International Aegean Conference, Italian School of Archaeology in Athens, 14-18 April 2004. Liège, Belgium: Université de Liège.

Pusch, E. 1990. "Metallverarbeitende Werkstätten der frühen Ramessidenzeit in Qantir-Piramesse/Nord." *Ägypten und Levante* 1:75-113, Pl. I-VIII.

\_\_\_\_\_ 1994. "Divergierende Verfahren der Metallverarbeitung in Theben und Qantir? Bemerkungen zu Konstruktion und Technik." *Ägypten und Levante* 4:145-70.

- \_\_\_\_\_ 1995. "High Temperature Industries in the Late Bronze Age Capital of Piramesse (Qantir): II. A Quasi-Industrial Bronze Factory Installation, Tools, and Artifacts." In *Proceedings of the First International Conference on Egyptian Mining and Metallurgy and Conservation of Metallic Artifacts*, edited by F. A. Esmael, 121-32. Cairo, Egypt: Ministry of Culture, Supreme Council of Antiquities.
- Pydyn, A. 2000. "Value and Exchange of Bronzes in the Baltic Area and in North-East Europe." In *Metals Make the World Go Round: The Supply and Circulation of Metals in Bronze Age Europe. Proceedings of a Conference held at the University of Birmingham in June 1997*, edited by C. F. E. Pare, 225-32. Oxford UK: Oxbow Books.
- Raban, A., and E. Galili. 1985. "Recent Maritime Archaeological Research in Israel—a Preliminary Report." *IJNA* 14(4):321-56.
- Raber, P. 1987. "Early Copper Production in the Polis Region, Western Cyprus." *JFA* 14.3:297-312.
- Rapp, G. 1982. "Native Copper and the Beginning of Smelting: Chemical Studies." In *Early Metallurgy in Cyprus, 4000-500 B.C.*, edited by J. D. Muhly, R. Maddin, and V. Karageorghis, 33-40. Nicosia, Cyprus: Department of Antiquities.
- \_\_\_\_\_ 1989. "Determining the Origins of Sulfide Smelting." In *Old World Archaeometallurgy*, edited by A. Hauptmann, E. Pernicka, and G. A. Wagner, 107-10. Bochum, Germany: Selbstverlag des Deutschen Bergbau-Museums.
- \_\_\_\_\_ 1999. "Copper, Tin, and Arsenic Sources in the Aegean Bronze Age." In *Meletemata: Studies in Aegean Archaeology Presented to Malcolm H. Wiener as*

- He Enters His 65<sup>th</sup> Year, v.III*, edited by P. P. Betancourt, V. Karageorghis, R. Laffineur, and W.-D. Niemeier, 699-704. Eupen, Belgium: KLIEMO SA B-4700.
- Rapp, G., R. Rothe and Z. Jing. 1999. "Using Neutron Activation Analysis to Source Ancient Tin." In *Metals in Antiquity*, edited by S. M. M. Young, A. M. Pollard, P. Budd and R. A. Ixer, 153-62. BAR-IS 792. Oxford UK: Archaeopress.
- Reade, J. E. 1980. "The Rassam Obelisk." *Iraq* 42:1-22.
- Redford, D. B. 1992. *Egypt, Canaan, and Israel in Ancient Times*. Princeton, NJ: Princeton University Press.
- Rehder, J. E. 1999. "High Temperature Technology in Antiquity: A Sourcebook on the Design and Operation of Ancient Furnaces." In *The Beginnings of Metallurgy: Proceedings of the International Conference 'The Beginnings of Metallurgy', Bochum 1995*, edited by A. Hauptmann, E. Pernicka, T. Rehren, and Ü. Yalçin, 305-16. Bochum, Germany: Bergbau-Museum.
- Rehren, Th. 1991. "Selenium and Tellurium in Mediterranean Copper Ingots." In *Bronze Age Trade in the Mediterranean*, edited by N. H. Gale, 240-9. SIMA v. XC. Jonsered, Sweden: Paul Åströms Förlag.
- Renfrew, C., and P. Bahn. 1996. *Archaeology: Theories, Methods and Practice*. New York: Thames & Hudson.
- Ridgway, D. 1996. "Relations between Cyprus and the West in the Precolonial Period." In *The Greek World. Art and Civilization in Magna Graecia and Sicily*, edited by G. P. Carratelli, 117-20. Milan, Italy: R. C. S. Libri & Grandi Opere S. P. A.

- Robb, J. E., and R. Helen Farr. 2005. "Substances in Motion: Neolithic Mediterranean 'Trade'." In *The Archaeology of Mediterranean Prehistory*, edited by E. Blake and A. B. Knapp, 24-45. Malden, MA: Blackwell Publishing.
- Robertson, N. 1978. "The Goddess on the Ingot in Greco-Roman Times." *RDAC*:202-5, Pl. LI.
- Rothenberg, B. 1988. *The Egyptian Mining Temple at Timna*. Researches in the Arabah 1959-1984, Volume I. Farnborough: Thames & Hudson.
- Rothenberg, B. (ed.). 1990. *The Ancient Metallurgy of Copper*. London: Institute for Archaeo-Metallurgical Studies.
- Rothenberg, B., and J. Glass. 1992. "The Beginnings and the Development of Early Metallurgy and the Settlement and Chronology of the Western Arabah, from the Chalcolithic Period to Early Bronze Age IV." *Levant* 24:141-57.
- Rothenberg, B., and J. Merkel. 1999. "The Earliest Steps to Copper Metallurgy in the Western Arabah." In *The Beginnings of Metallurgy*, edited by A. Hauptmann, E. Pernicka, T. Rehren, and Ü. Yalçın, 149-65. Bochum, Germany: Bergbau-Museum.
- Rothenberg, B., R. F. Tylecote, and P. J. Boydell. 1978. *Chalcolithic Copper Smelting: Excavations and Experiments*. Institute for Archaeometallurgical Studies Monograph #1. London: Institute for Archaeo-Metallurgical Studies.
- Rowland, R. J. 2001. *The Periphery in the Center: Sardinia in the Ancient and Medieval Worlds*. BAR-IS 970. Oxford UK: Oxbow Books.
- Ruiz-Gálvez, M. 2000. "Weight Systems and Exchange Networks in Bronze Age Europe." In *Metals Make the World Go Round: The Supply and Circulation of*

- Metals in Bronze Age Europe. Proceedings of a Conference held at the University of Birmingham in June 1997*, edited by C. F. E. Pare, 267-79. Oxford UK: Oxbow Books.
- Ruiz-Galvez Priego, M. 2003. "Investigating Weight Systems in Nuragic Sardinia." In *The Problem of Early Tin*, edited by A. Giumlia-Mair and F. LoSchiavo, 149-58. BAR-IS 1199. Oxford UK: Archaeopress.
- Rupp, D. W., L. W. Sorenson, R. H. King, and W. A. Fox. 1984. "Canadian Palaepaphos (Cyprus) Survey Project: Second Preliminary Report, 1980-1982." *JFA* 11(2):133-54.
- Rutter, J. B. 1999. "Cretan External Relations During LM IIIA2-B (ca. 1370-1200 BC): A View from the Mesara." In *The Point Iria Wreck: Interconnections in the Mediterranean c. 1200 BC*, 139-86. Athens, Greece: Hellenic Institute of Marine Archaeology.
- Rystedt, E. 1986. "Oxhide Ingots or Camp Stools? Notes on a Motif in Mycenaean Pictorial Vase Painting." *RDAC*, 49-56, Pl. XVI.
- Sandars, N. K. 1985. *The Sea Peoples: Warriors of the Ancient Mediterranean*. London: Thames & Hudson.
- Sasson, J. 1966. "Canaanite Maritime Involvement in the Second Millennium." *JAOS* 86:126-38.
- Säve-Söderbergh, T. 1957. *Four Eighteenth Dynasty Tombs*. Oxford UK: Oxford University Press.
- Sayre, E. V., E. C. Joel, M. J. Blackman, K. A. Yener, and H. Özbal. 2001. "Stable Lead Isotope Studies of Black Sea Anatolian Ore Sources and Related Bronze Age and

- Phrygian Artefacts from Nearby Archaeological Sites. Appendix: New Central Taurus Ore Data.” *Archaeometry* 43(1):77-115.
- Scaife, B., P. Budd, J. G. McDonnell, and A. M. Pollard. 1999. "Lead Isotope Analysis, Oxhide Ingots, and the Presentation of Scientific Data in Archaeology." In *Metals in Antiquity*, edited by S. M. M. Young, A. Mark Pollard, P. Budd, and R. A. Ixer, 110-21. BAR-IS 792. Oxford UK: Archaeopress.
- Schaeffer, C. F. A. 1952. *Enkomi-Alasia I*. Paris: Librairie C. Klincksieck.
- \_\_\_\_\_ 1971. "Les Peuples de la Mer et Leurs Sanctuaires a Enkomi-Alasia aux XIIe-XIe S. Av. N. È." In *Alasia I*, edited by C. F.-A. Schaeffer, 505-566. Leiden, Holland: E. J. Brill.
- Schäfer, H. 1974. *Principles of Egyptian Art*. Translated and edited by J. Baines and E. Brummer-Traut. Oxford UK: Clarendon Press.
- Schneider, T. 2005. "Ägypten in der Spätbronzezeit." In *Das Schiff von Uluburun. Welthandel vor 3000 Jahren*, edited by Yalçın, Ü., C. Pulak, and R. Slotta, 227-34. Bochum, Germany: Deutsches Bergbau-Museum.
- Seltman, C. T. 1974. *Athens: Its History and Coinage Before the Persian Invasion*. Chicago, IL: Ares Publishers.
- Sertok, K., and H. Güllüce. 2005. "Ochsenhautbarren aus dem mittleren Euphratgebiet." In *Das Schiff von Uluburun. Welthandel vor 3000 Jahren. Katalog der Ausstellung des Deutschen Bergbau-Museums Bochum vom 15. Juli 2005 bis 16. Juli 2006*, edited by Yalçın, Ü., C. Pulak, and R. Slotta, 393-8. Bochum, Germany: Deutsches Bergbau-Museum.



- Shaw, I. 1998. "Exploiting the Desert Frontier: the Logistics and Politics of Ancient Egyptian Mining Expeditions." In *Social Approaches to an Industrial Past: The Archaeology and Anthropology of Mining*, edited by A. B. Knapp, V. C. Piggott, and E. W. Herbert, 242-258. London: Routledge.
- Shaw, I., and P. Nicholson. 1995. *The Dictionary of Ancient Egypt*. London: British Museum.
- Shaw, J. W. 2004. "Kommos: The Sea-Gate to Southern Crete." In *Crete Beyond the Palaces: Proceedings of the Crete 2000 Conference*, edited by L. P. Day, M. S. Mook, and J. D. Muhly, 43-51. Prehistory Monographs 10. Philadelphia, PA: INSTAP Academic Press.
- Shaw, J. W., and H. Blitzer. 1983. "Stone Weight Anchors from Kommos, Crete." *IJNA* 12(2):91-100.
- Shennan, S. 1998. "Producing Copper in the Eastern Alps During the Second Millennium BC." In *Social Approaches to an Industrial Past: The Archaeology and Anthropology of Mining*, edited by A. B. Knapp, V. C. Piggott, and E. W. Herbert, 191-204. London: Routledge.
- \_\_\_\_\_ 1999. "Cost, Benefit, and Value in the Organization of Early Copper Production." *Antiquity* 73:352-63.
- Shepherd, R. 1993. *Ancient Mining*. London: Elsevier Applied Science.
- Sherratt, A. 1993. "'Who Are You Calling Peripheral?' Dependence and Independence in European Prehistory." In *Trade and Exchange in Prehistoric Europe*, edited by C. Scarre and F. Healy, 245-55. Proceedings of a Conference held at the

University of Bristol, April 1992. Oxbow Monographs 33. Oxford UK: Oxbow Books.

Sherratt, S. 1994. "Commerce, Iron, and Ideology: Metallurgical Innovation in 12<sup>th</sup>-11<sup>th</sup> Century Cyprus." In *Cyprus in the 11<sup>th</sup> Century B.C.*, edited by V. Karageorghis, 59-108. Nicosia, Cyprus: A. G. Leventis Foundation.

\_\_\_\_\_ 1998. "'Sea Peoples' and the Economic Structure of the Late Second Millennium in the Eastern Mediterranean." In *Mediterranean Peoples in Transition, Thirteenth to Early Tenth Centuries BCE*, edited by S. Gitin, A. Mazar, and E. Stern, 292-313. Jerusalem: Israel Exploration Society.

\_\_\_\_\_ 2000. "Circulation of Metals at the End of the Bronze Age in the Eastern Mediterranean." In *Metals Make the World Go Round: The Supply and Circulation of Metals in Bronze Age Europe. Proceedings of a Conference held at the University of Birmingham in June 1997*, edited by C. F. E. Pare, 82-98. Oxford UK: Oxbow Books.

Sherratt, A., and S. Sherratt. 1991. "From Luxuries to Commodities: the Nature of Mediterranean Bronze Age Trading Systems." In *Bronze Age Trade in the Mediterranean*, edited by N. H. Gale, 1-15. Studies in Mediterranean Archaeology, vol. XC. Jonsered, Sweden: Paul Åströms Förlag.

Sibella, P. 1996. "The Copper Oxhide and Bun Ingots." *INA Quarterly* 23(1):9-11.

Skarpelis, N. 2003. "Potential Tin Sources in the Aegean." In *The Problem of Early Tin*, edited by A. Giunlia-Mair and F. LoSchiavo, 159-64. BAR-IS 1199. Oxford UK: Archaeopress.

- Smith, C. S., and M. T. Gnudi (tr.). 1966. *The Pirotechnia of Vannoccio Biringuccio*. Cambridge, MA: MIT Press.
- Smith, J. S. 2002. "Problems and Prospects in the Study of Script and Seal Use on Cyprus in the Bronze and Iron Ages." In *Script and Seal Use in the Bronze and Iron Ages*, edited by J. S. Smith, 1-48. Boston, MA: Archaeological Institute of America.
- Smith, T. R. 1987. *Mycenaean Trade and Interaction in the West Central Mediterranean, 1600-1000 B.C.* BAR-IS 371. Oxford UK: British Archaeological Reports.
- Snodgrass, A. M. 1980. "Iron and Early Metallurgy in the Mediterranean." In *The Coming of the Age of Iron, 335-74*. New Haven, CT: Yale University Press.
- \_\_\_\_\_ 1982. "Cyprus and the Beginnings of Iron Technology in the Eastern Mediterranean." In *Early Metallurgy in Cyprus, 4000-500 B.C.*, edited by J. D. Muhly, R. Maddin, and V. Karageorghis, 285-96. Nicosia, Cyprus: Department of Antiquities.
- \_\_\_\_\_ 1991. "Bronze Age Exchange: A Minimalist Position." In *Bronze Age Trade in the Mediterranean*, edited by N. H. Gale, 16-20. SIMA v. XC. Jonsered, Sweden: Paul Åströms Förlag.
- Soles, J. S., and C. Davaras. 1994. "Excavations at Mochlos, 1990-1991." *Hesperia* 63(4):391-436.
- \_\_\_\_\_ 1996. "Excavations at Mochlos, 1992-1993." *Hesperia* 65(2):175-230.
- \_\_\_\_\_ 2005. "Excavations at Mochlos, Crete, in 2004." Paper read at the Annual Meeting of the Archaeological Institute of America, 6-9<sup>th</sup> January, Boston.

- Soles, J. S., and Z. A. Stos-Gale. 2004. "The Metal Finds and Their Geological Sources." In *Mochlos IC. Period III. Neopalatial Settlement on the Coast: The Artisans' Quarter and the Farmhouse at Chalinomouri. The Small Finds*, by Soles, J. S., C. Davaras, J. Bending, T. Carter, D. Kondopoulou, D. Mylona, M. Ntinou, A. M. Nicgorski, D. S. Reese, A. Sarpaki, W. H. Schoch, M. E. Soles, V. Spatharas, Z. A. Stos-Gale, D. H. Tarling, and C. Witmore, 45-60. Philadelphia, PA: INSTAP Academic Press.
- Soles, J. S., C. Davaras, J. Bending, T. Carter, D. Kondopoulou, D. Mylona, M. Ntinou, A. M. Nicgorski, D. S. Reese, A. Sarpaki, W. H. Schoch, M. E. Soles, V. Spatharas, Z. A. Stos-Gale, D. H. Tarling, and C. Witmore. 2004. *Mochlos IC. Period III. Neopalatial Settlement on the Coast: The Artisans' Quarter and the Farmhouse at Chalinomouri. The Small Finds*. Philadelphia, PA: INSTAP Academic Press.
- South, A. K. 1980. "Kalavassos-Ayios-Dhimitrios 1979; Summary Report." *RDAC*:22-53.
- \_\_\_\_\_ 1989. "From Copper to Kingship: Aspects of Bronze Age Society Viewed from the Vasilikos Valley." In *Early Society in Cyprus*, edited by E. Peltenberg, 315-24. Edinburgh, Scotland: Edinburgh University Press.
- \_\_\_\_\_ 1996. "Kalavassos Ayios Dhimitrios and the Organisation of Late Bronze Age Cyprus." In *Late Bronze Age Settlement in Cyprus: Function and Relationship*, edited by P. Åström and E. Herscher, 39-49. Jonsered, Sweden: Paul Åströms Förlag.
- \_\_\_\_\_ 1997. "Kalavassos-Ayios Dhimitrios 1992-1996." *RDAC*:151-75.

- South, A., P. Russell, and P. S. Keswani. 1989. *Vasilikos Valley Project 3: Kalavassos-Ayios-Dhimitrios II: Ceramics, Objects, Tombs, Specialist Studies*. SIMA v. LXXI: 3. Göteborg, Sweden: Paul Åströms Förlag.
- Stager, L. E. 1995. "The Impact of the Sea Peoples in Canaan (1185-1050 BCE)." In *The Archaeology of Society in the Holy Land*, edited by T. E. Levy, 332-48. New York: Facts on File.
- Stech, T. 1982. "Urban Metallurgy in Late Bronze Age Cyprus." In *Early Metallurgy in Cyprus, 4000-500 B.C.*, edited by J. D. Muhly, R. Maddin, and V. Karageorghis, 105-16. Nicosia, Cyprus: Department of Antiquities.
- \_\_\_\_\_ 1985. "Copper and Society in Late Bronze Age Cyprus." In *Prehistoric Production and Exchange: The Aegean and Eastern Mediterranean*, edited by A. B. Knapp and T. Stech, 100-5. Los Angeles: Institute of Archaeology, University of California.
- \_\_\_\_\_ 1989. "Nuragic Metallurgy in Sardinia. Third Preliminary Report." In *Old World Archaeometallurgy*, edited by A. Hauptmann, E. Pernicka, and G. A. Wagner, 39-44. Bochum, Germany: Selbstverlag des Deutschen Bergbau-Museums.
- Stech, T., and V. C. Piggott. 1986. "The Metals Trade in Southwest Asia in the Third Millennium BC". *Iraq* 48:39-64.
- Stech, T., R. Maddin, and J. D. Muhly. 1985. "Copper Production at Kition in the Late Bronze Age." In *Excavations at Kition, v. 5, pt. 1A: The Pre-Phoenician Levels*, by V. Karageorghis and M. Demas, 388-402. Nicosia, Cyprus: Department of Antiquities.

- Steel, L. 2004. *Cyprus Before History: From the Earliest Settlers to the End of the Bronze Age*. London: Duckworth & Co., Ltd.
- Stos-Gale, Z. A. 1988. "Lead Isotope Evidence for Trade in Copper from Cyprus During the Late Bronze Age." In *Problems in Greek Prehistory*, edited by E. B. French and K. A. Wardle, 265-82. Papers Presented at the Centenary Conference of the British School of Archaeology at Athens, Manchester, April 1986. Bristol, England: Bristol Classical Press.
- \_\_\_\_\_ 1989. "Cycladic Copper Metallurgy." In *Old World Archaeometallurgy*, edited by A. Hauptmann, E. Pernicka, and G. A. Wagner, 279-92. Bochum, Germany: Selbstverlag des Deutschen Bergbau-Museums.
- \_\_\_\_\_ 1993. "The Origin for Metal Used for Making Weapons in Early and Middle Minoan Crete." In *Trade and Exchange in Prehistoric Europe*, edited by C. Scarre and F. Healy, 115-30. Proceedings of a Conference held at the University of Bristol, April 1992. Oxbow Monograph 33. Oxford UK: Oxbow Books.
- \_\_\_\_\_ 1998. "The Role of Kythnos and Other Cycladic Islands in the Origins of Early Minoan Metallurgy." In *Kea-Kythnos: History and Archaeology*, edited by L. G. Mendoni and A. J. Mazarakis Ainian, 717-36. Athens, Greece: Research Center for Greek and Roman Antiquity/National Hellenic Research Foundation.
- \_\_\_\_\_ 2000. "Trade in Metals in the Bronze Age Mediterranean: an Overview of Lead Isotope Data for Provenance Studies." In *Metals Make the World Go Round: The Supply and Circulation of Metals in Bronze Age Europe*.

*Proceedings of a Conference held at the University of Birmingham in June 1997*, edited by C. F. E. Pare, 56-69. Oxford UK: Oxbow Books.

Stos-Gale, Z. A., and N. H. Gale. 1983. "The Minoan Thalassocracy and the Aegean Metal Trade." In *The Minoan Thalassocracy: Myth and Reality. Proceedings of the Third International Symposium at the Swedish Institute in Athens, 31 May-5 June 1982*, edited by R. Hagg and N. Marinatos, 59-64. Göteborg, Sweden: Paul Åströms Förlag.

\_\_\_\_\_ 1987. "Oxhide Ingots from Sardinia, Crete, and Cyprus and the Bronze Age Copper Trade: New Scientific Evidence." In *Studies in Sardinian Archaeology III: Nuragic Sardinia and the Mycenaean World*, edited by M. S. Balmuth, 135-78. BAR-IS 387. Oxford UK: British Archaeological Reports.

\_\_\_\_\_ 1990. "The Role of Thera in the Bronze Age Trade in Metals." In *Thera and the Aegean World III: Volume I: Archaeology*, edited by D. A. Hardy, 72-92. Proceedings of the Third International Congress, Santorini, Greece, 3-9 September, 1989. London: The Thera Foundation.

\_\_\_\_\_ 1992. "New Light on the Provenience of the Copper Oxhide Ingots Found on Sardinia." In *Sardinia in the Mediterranean: A Footprint in the Sea*, edited by R. H. Tykot and T. K. Andrews, p. 317-46. Sheffield, UK: Sheffield Academic Press.

\_\_\_\_\_ 1994. "Metals." In *Provenience Studies and Bronze Age Cyprus: Production, Exchange, and Politico-Economic Change*, by A. B. Knapp and J. F. Cherry, 92-121. Monographs in World Archaeology No. 21. Madison, WI: Prehistory Press.

- Stos-Gale, Z. A., and C. F. McDonald. 1991. "Sources of Metal and Trade in the Bronze Age Aegean." In *Bronze Age Trade in the Mediterranean*, edited by N. H. Gale, 249-89. SIMA v. XC. Jonsered, Sweden: Paul Åströms Förlag.
- Stos-Gale, Z. A., G. Maliotis, N. H. Gale, and N. Annetts. 1997. "Lead Isotope Characteristics of the Cyprus Ore Deposits Applied to the Provenance Studies of Copper Oxhide Ingots." *Archaeometry* 39(1):83-124.
- Stos-Gale, Z. A., N. H. Gale, G. Bass, C. Pulak, E. Galili, and J. Sharvit. 1998. "The Copper and Tin Ingots of the Late Bronze Age: New Scientific Evidence." In *Proceedings of the Fourth International Conference on the Beginnings of the Use of Metals and Alloys (BUMA IV)*, 115-26. Aoba, Japan: The Japan Institute of Metals.
- Strange, J. 1980. *Caphtor/Keftiu: A New Investigation*. Leiden, Holland: E. J. Brill.
- Stubbings, F. H. 1979a. "A Bronze Founder's Hoard." In *Excavations at Mycenae 1939-1955*, edited by E. French, 292-6. Reprinted from the Annual of the British School at Athens, v. 45-56. London: The British School of Archaeology at Athens/ Thames & Hudson.
- \_\_\_\_\_ 1979b. "A Winged Axe Mould." In *Excavations at Mycenae 1939-1955*, edited by E. French, 297-8. Reprinted from the Annual of the British School at Athens, v. 45-56. London: The British School of Archaeology at Athens/ Thames & Hudson.
- Swiny, S. 1981. "Bronze Age Settlement Patterns in Southwest Cyprus." *Levant* XIII:51-87.



- \_\_\_\_\_ 1982. "Correlations Between the Composition and Function of Bronze Age Metal Types in Cyprus." In *Early Metallurgy in Cyprus, 4000-500 B.C.*, edited by J. D. Muhly, R. Maddin, and V. Karageorghis, p. 69-80. Nicosia, Cyprus: Department of Antiquities.
- Symington, D. 1991. "Late Bronze Age Writing Boards and Their Uses: Textual Evidence from Anatolia and Syria." *AnatSt* 41:111-23.
- Trump, D. H. 1992. "Militarism in Nuragic Sardinia." In *Sardinia in the Mediterranean: A Footprint in the Sea*, edited by R. H. Tykot and T. K. Andrews, 198-203. Sheffield, UK: Sheffield Academic Press.
- Tylecote, R. F. 1962. *Metallurgy in Archaeology*. London: Edward Arnold Publishers Ltd.
- \_\_\_\_\_ 1971. "Observations on Cypriot Copper Smelting." *RDAC*:53-8.
- \_\_\_\_\_ 1976. "Properties of Copper Ingots of Late Bronze Age Type." In *Festschrift für Richard Pittioni zum siebzigsten Geburtstag*, edited by H. Mitscha-Märheim, H. Friesinger, and H. Kerchler, 157-71. *Archaeologia Austriaca*, Beiheft 14. Vienna, Austria: Horn.
- \_\_\_\_\_ 1977. "Summary of Results of Experimental Work on Early Copper Smelting." In *Aspects of Early Metallurgy*, edited by W. A. Oddy, 5-12. London: Historical Metallurgy Society and the British Museum Research Laboratory.
- \_\_\_\_\_ 1980. "Furnaces, Crucibles, and Slags." In *The Coming of the Age of Iron*, 183-228. New Haven, CT: Yale University Press.
- \_\_\_\_\_ 1981. "From Pot Bellows to Tuyeres." *Levant* XIII:107-18.

- \_\_\_\_\_ 1982a. "The Late Bronze Age: Copper and Bronze Metallurgy at Enkomi and Kition." In *Early Metallurgy in Cyprus, 4000-500 B.C.*, edited by J. D. Muhly, R. Maddin, and V. Karageorghis, 81-104. Nicosia: Department of Antiquities, Cyprus.
- \_\_\_\_\_ 1982b. "Metallurgical Crucibles and Crucible Slags." In *Archaeological Ceramics*, edited by J. S. Olin and A. D. Franklin, 231-43. Washington D. C.: Smithsonian Institution Press.
- \_\_\_\_\_ 1986a. *The Prehistory of Metallurgy in the British Isles*. London: The Institute of Metals.
- \_\_\_\_\_ 1986b. "Appendix II. Metallographic Examination of Copper-Base Alloy Specimens from Episkopi Phaneromeni, Cyprus, of the Middle-Late Cypriot Period (2000-1650 BC). In *The Kent State University Expedition to Episkopi Phaneromeni. Part 2*, by S. Swiny, with contributions by P. T. Craddock and R. F. Tylecote, 159-63. SIMA LXXIV: 2. Nicosia, Cyprus: Paul Åströms Förlag.
- \_\_\_\_\_ 1987a. *The Early History of Metallurgy in Europe*. London: Longman Group UK Ltd.
- \_\_\_\_\_ 1987b. "Commentary on Metallurgy Session." In *Studies in Sardinian Archaeology III: Nuragic Sardinia and the Mycenaean World*, edited by M. S. Balmuth, 223-4. BAR-IS 387. Oxford UK: British Archaeological Reports.
- Tylecote, R. F., H. A. Ghaznavi, and P. J. Boydell. 1977. "Partitioning of Trace Elements Between the Ores, Fluxes, Slags, and Metal During the Smelting of Copper." *JAS* 4: 305-33.

- Tylecote, R. F., M. S. Balmuth, and R. Massoli-Novelli. 1984. "Copper and Bronze Metallurgy in Sardinia." In *Studies in Sardinian Archaeology*, edited by M. S. Balmuth and R. J. Rowland, 115-62. Ann Arbor, MI: The University of Michigan Press.
- Vagnetti, L. 1996. "The First Contacts between the Minoan-Mycenaean and the Western Mediterranean Worlds." In *The Greek World. Art and Civilization in Magna Graecia and Sicily*, edited by G. P. Carratelli, 109-16. Milan, Italy: R. C. S. Libri & Grandi Opere S. P. A.
- \_\_\_\_\_. 1999. "Mycenaeans and Cypriots in the Central Mediterranean Before and After 1200 BC." In *The Point Iria Wreck: Interconnections in the Mediterranean ca. 1200 BC*, edited by W. Phelps, Y. Lolos, and Y. Vichos, 187-208. Athens, Greece: Hellenic Institute of Marine Archaeology (HIMA).
- \_\_\_\_\_. 2001. "Some Observations on Late Cypriot Pottery from the Central Mediterranean." In *Italy and Cyprus in Antiquity: 1500-450 BC*, edited by L. Bonfante and V. Karageorghis, 77-96. Nicosia, Cyprus: Costakis and Leto Severis Foundation.
- Vagnetti, L., and F. L. Schiavo. 1989. "Late Bronze Age Long Distance Trade in the Mediterranean: the Role of the Cypriots." In *Early Society in Cyprus*, edited by E. Peltenburg, 217-243. Edinburgh, Scotland: Edinburgh University Press.
- Valera, R., and P. Valera. 2003. "Tin in the Mediterranean Area: History and Geology." In *The Problem of Early Tin*, edited by A. Giumlia-Mair and F. LoSchiavo, 3-14. BAR-IS 1199. Oxford UK: Archaeopress.

- Veenhof, K. R. 1972. *Aspects of Old Assyrian Trade and Its Terminology*. Leiden, Holland: E. J. Brill.
- \_\_\_\_\_ 1977. "Some Social Effects of Old Assyrian Trade." *Iraq* 39(1):109-18.
- Ventris, M., and J. Chadwick. 1973. *Documents in Mycenaean Greek*. Cambridge, UK: Cambridge University Press.
- Vermeule, E. T. 1974. *Toumba tou Skorou, the Mound of Darkness. A Bronze Age Town on Morphou Bay in Cyprus*. Boston, MA: Harvard University-Museum of Fine Arts Cyprus Expedition.
- \_\_\_\_\_ 1996. "Toumba Tou Skorou." In *Late Bronze Age Settlement in Cyprus: Function and Relationship*, edited by P. Åström and E. Herscher, 50-3. Jonsered, Sweden: Paul Åströms Förlag.
- Vermeule, E. D. T., and F. Z. Wolsky. 1990. *Toumba tou Skorou*. Cambridge, MA: Harvard University Press.
- Vichos, Y. 1999. "The Point Iria Wreck: The Nautical Dimension." In *The Point Iria Wreck: Interconnections in the Mediterranean ca. 1200 BC*, edited by W. Phelps, Y. Lolos, and Y. Vichos, 77-98. Athens, Greece: Hellenic Institute of Marine Archaeology (HIMA).
- Wachsmann, S. 1987. *Aegeans in the Theban Tombs*. *Orientalia Lovaniensia Analecta* 20. Leuven, Belgium: Uitgeveru Peeters.
- \_\_\_\_\_ 1998. *Seagoing Ships and Seamanship in the Bronze Age Levant*. College Station: Texas A&M University Press.
- Wachsmann, S., and K. Raveh. 1984. "Concerning a Lead Ingot Fragment from Ha-Hotrim, Israel." *IJNA* 13(2):169-76.

- Wagner, G. A., N. Gentner, H. Gropengiesser, and N. H. Gale. 1980. "Early Bronze Age Lead-Silver Mining and Metallurgy in the Aegean: The Ancient Workings on Siphnos." In *Scientific Studies in Early Mining and Extractive Metallurgy*, edited by P. T. Craddock, 63-86. British Museum Occasional Papers No. 20. London: British Museum.
- Waldbaum, J. C. 1980. "The First Archaeological Appearance of Iron and the Transition to the Iron Age." In *The Coming of the Age of Iron*, 69-98. New Haven, CT: Yale University Press.
- \_\_\_\_\_ 1982. "Bimetallic Objects from the Eastern Mediterranean and the Question of the Dissemination of Iron." In *Early Metallurgy in Cyprus, 4000-500 B.C.*, edited by J. D. Muhly, R. Maddin, and V. Karageorghis, 325-50. Nicosia, Cyprus: Department of Antiquities.
- Wang, Q., and B. Ottoway. 2003. "Casting and Metallography of Tin Bronzes in Clay Moulds." In *The Problem of Early Tin*, edited by A. Giunlia-Mair and F. LoSchiavo, 35-54. BAR-IS 1199. Oxford UK: Archaeopress.
- Warren, P. 1995. "Minoan Crete and Pharaonic Egypt." In *Egypt, the Aegean, and the Levant: Interconnections in the Second Millennium BC*, edited by W. V. Davies and L. Schofield, 1-18. London: British Museum Press.
- Watrous, L. V. 1992. *Kommos III. The Late Bronze Age Pottery*. Princeton, NJ: Princeton University Press.
- Watrous, L. V., P. M. Day, and R. E. Jones. 1998. "The Sardinian Pottery from the Late Bronze Age Site of Kommos in Crete: Description, Chemical and Petrographic Analyses, and Historical Context." In *Sardinian and Aegean Chronology*:

- Towards the Resolution of Relative and Absolute Dating in the Mediterranean*, edited by M. S. Balmuth and R. H. Tykot, 337-40. Studies in Sardinian Archaeology V. Oxford UK: Oxbow Books.
- Wayman, M. L. 1989. "Native Copper: Humanity's Introduction to Metallurgy?" In *All That Glitters: Readings in Historical Metallurgy*, edited by M. L. Wayman, 3-7. Montreal: The Canadian Institute of Mining and Metallurgy.
- Wayman, M. L., and M. G. M. Duke. 1999. "The Effects of Melting on Native Copper. In *The Beginnings of Metallurgy*, edited by A. Hauptmann, E. Pernicka, T. Rehren, and Ü. Yalçin, 55-66. Bochum, Germany: Bergbau-Museum.
- Webb, J. M. 1999. *Ritual Architecture, Iconography and Practice in the Late Cypriot Bronze Age*. Jonsered, Sweden: Paul Åströms Förlag.
- \_\_\_\_\_. 2001. "The Sanctuary of the Ingot God at Enkomi. A New Reading of its Construction, Use, and Abandonment." In *Contributions to the archaeology and history of the Bronze and Iron Ages in the Eastern Mediterranean: studies in honour of Paul Åström*, edited by P. M. Fischer, 69-82. Sonderschriften des Österreichischen Archäologischen Instituts 39. Vienna, Austria: Österreichisches Archäologisches Institut.
- Webb, J. M., and D. Frankel. 1994. "Making an Impression: Storage and Surplus in Late Bronze Age Cyprus." *JMA* 7(1):5-26.
- Weeks, L. R. 2003. *Early Metallurgy of the Persian Gulf*. Boston, MA: Brill Academic Publishers.
- Weisgerber, G. 1982. "Towards a History of Copper Mining in Cyprus and the Near East: Possibilities of Mining Archaeology." In *Early Metallurgy in Cyprus, 4000-*

500 B.C., edited by J. D. Muhly, R. Maddin, and V. Karageorghis, 25-32.

Nicosia, Cyprus: Department of Antiquities.

\_\_\_\_\_ 1983. "Copper Production during the Third Millennium BC in Oman and the Question of Makan." *Journal of Oman Studies* 6:269-76.

\_\_\_\_\_ 2003. "Spatial Organisation of Mining and Smelting at Feinan, Jordan: Mining Archaeology Beyond the History of Technology." In *Mining and Metal Production Through the Ages*, edited by P. T. Craddock and J. Lang, 76-89. London: British Museum Press.

Weisgerber, G., and A. Hauptmann. 1988. "Early Copper Mining and Smelting in Palestine." In *The Beginning of the Use of Metals and Alloys*, edited by R. Maddin, 52-62. Cambridge, MA: The MIT Press.

Wells, L. A. 2001. "A Geomorphological Approach to Reconstructing Archaeological Settlement Patterns Based on Surficial Artifact Distribution: Replacing Humans on the Landscape." In *Earth Sciences in Archaeology*, edited by P. Goldberg, V. T. Holliday, and C. Reid Ferring, 107-41. New York: Kluwer Academic/Plenum Publishers.

Wertime, T. A. 1978. "The Search for Ancient Tin: The Geographic and Historic Boundaries." In *The Search for Ancient Tin*, edited by A. D. Franklin, J. S. Olin, and T. A. Wertime, 1-6. Washington D.C.: U. S. Government Printing Office.

\_\_\_\_\_ 1980. "The Pyrotechnologic Background." In *The Coming of the Age of Iron*, 1-24. New Haven, CT: Yale University Press.

\_\_\_\_\_ 1982. "Cypriot Metallurgy Against the Backdrop of Mediterranean Pyrotechnology: Energy Reconsidered." In *Early Metallurgy in Cyprus, 4000-*

500 B.C., edited by J. D. Muhly, R. Maddin, and V. Karageorghis, 351-62.

Nicosia, Cyprus: Department of Antiquities.

Westover, S. B. 1999. "Smelting and Sacrifice: Comparative Analysis of Greek and Near Eastern Cult Sites from the Late Bronze through the Classical Periods." In *Metals in Antiquity*, edited by S. M. M. Young, A. Mark Pollard, P. Budd, and R. A.

Ixer, 86-90. BAR-IS 792. Oxford UK: Archaeopress.

Wheeler, T. S., and R. Maddin. 1980. "Metallurgy and Ancient Man." In *The Coming of the Age of Iron*, edited by T. A. Wertime and J. D. Muhly, 99-126. New Haven, CT: Yale University Press.

Whitley, J. (ed.). 2005. "Mochlos." In *Archaeological Reports for 2004-2005*, 102-4.

London: Council of the Society for the Promotion of Hellenic Studies and the Council of the British School at Athens.

Wiener, M. H. 1990. "The Isles of Crete? The Minoan Thalassocracy Revisited." In *Thera and the Aegean World III: Volume I: Archaeology*, edited by D. A. Hardy, 128-61. Proceedings of the Third International Congress, Santorini, Greece, 3-9 September, 1989. London: The Thera Foundation.

Willies, L. 1992. "Reply to Pernicka et al.: Comment on the Discussion of Ancient Tin Sources in Anatolia." *JMA* 5(1):99-103.

\_\_\_\_\_ 1993. "Appendix: Early Bronze Age Tin Working at Kestel." *AJA* 97:262-4.

Wiseman, D. J. 1953. *The Alalakh Tablets*. Liverpool, England: C. Tinling & Co.

Woodhead, A. P., N. H. Gale, and Z. A. Stos-Gale. 1999. "An Investigation into the Fractionation of Copper Isotopes and its Possible Application to



- Archaeometallurgy." In *Metals in Antiquity*, edited by S. M. M. Young, A. Mark Pollard, P. Budd, and R. A. Ixer, 134-9. BAR-IS 792. Oxford UK: Archaeopress.
- Yalçın, Ü., C. Pulak, and R. Slotta (eds.). 2005. *Das Schiff von Uluburun: Welthandel vor 3000 Jahren. Katalog der Ausstellung des Deutschen Bergbau-Museums Bochum vom 15. Juli 2005 bis 16. Juli 2006*. Bochum, Germany: Deutsches Bergbau-Museum.
- Yekutieli, Y., S. Shalev, and S. Shilstein. 2005. "En Yahav—A Copper Smelting Site in the 'Arava.'" *BASOR* 340:1-21.
- Yener, K. A. 2000. *The Domestication of Metals: The Rise of Complex Metal Industries in Anatolia*. Leiden, Holland: E. J. Brill.
- Yener, K. A., and M. Goodway. 1992. "Response to Mark E. Hall and Sharon R. Steadman 'Tin and Anatolia: Another Look.'" *JMA* 5(1):77-90.
- Yener, K. A., and P. B. Vandiver. 1993a. "Tin Processing at Göltepe, an Early Bronze Age Site in Anatolia." *AJA* 97:207-37.
- Yener, K. A., and P. B. Vandiver. 1993b. "Reply to J. D. Muhly, 'Early Bronze Age Tin and the Taurus.'" *AJA* 97:255-64.
- Yener, K. A., A. Adriaens, B. Earl, and H. Özbal. 2003. "Analyses of Metalliferous Residues, Crucible Fragments, Experimental Smelts, and Ores from Kestel Tin Mine and the Tin Processing Site of Göltepe, Turkey." In *Mining and Metal Production Through the Ages*, edited by P. T. Craddock and J. Lang, 181-97. London: British Museum Press.
- Zaccagnini, C. 1977. "The Merchant at Nuzi." *Iraq* 39(2):171-90.

\_\_\_\_\_ 1986. "Aspects of Copper Trade in the Eastern Mediterranean During the Late Bronze Age." In *Traffici Micenei nel Mediterraneo: Problemi Storici e Documentazione Archeologica: Atti del Convegno di Palermo (11-12 maggio e 3-6 dicembre 1984)*, 413-25. Magna Graecia 3. Taranto, Italy: Istituto per la storia e l'archeologia della Magna Grecia.

\_\_\_\_\_ 1987. "Aspects of Ceremonial Exchange in the Near East During the Late Second and Early First Millennium BC." In *Centre and Periphery in the Ancient World*, edited by M. Rowlands, M. Larsen, and K. Kristiansen, 57-65.

Cambridge, UK: Cambridge University Press.

Zwicker, U. 1982. "Bronze Age Metallurgy at Ambelikou-*Aletri* and Arsenical Copper in a Crucible from Episkopi-*Phaneromeni*." In *Early Metallurgy in Cyprus, 4000-500 B.C.*, edited by J. D. Muhly, R. Maddin, and V. Karageorghis, 63-8. Nicosia, Cyprus: Department of Antiquities.

\_\_\_\_\_ 1985. "Appendix VI. Investigation of Samples from the Metallurgical Workshops at Kition." In *Excavations at Kition V. The Pre-Phoenician Levels, Areas I and II, Part I*, by V. Karageorghis and M. Demas, 403-29. Nicosia, Cyprus: Department of Antiquities.

Zwicker, U., E. Gruembler, and H. Rollig. 1977. "Investigations on Copper-Slags from Cyprus (Second Report)." *RDAC*:309-16, Pl. LXXXI-LXXXIV.

Zwicker, V., P. Viridis, and M. L. Ceruti. 1980. "Investigations on Copper Ore, Prehistoric Copper Slag and Copper Ingots from Sardinia." In *Scientific Studies in Early Mining and Extractive Metallurgy*, edited by P. T. Craddock, 135-164. British Museum Occasional Papers No. 20. London: British Museum.

Zwicker, U., H. Greiner, K.-H. Hofmann, and M. Reithinger. 1985. "Smelting, Refining, and Alloying of Copper and Copper Alloys in Crucible-Furnaces During Prehistoric up to Roman times." In *Furnaces and Smelting Technology in Antiquity*, edited by P. T. Craddock and M. J. Hughes, 103-16. British Museum Occasional Paper No. 48. London: British Museum Publication

## APPENDIX 1

BRONZE AGE CHRONOLOGIES<sup>1534</sup>

EGYPT (New Kingdom Period pharaohs mentioned in text)	LEVANT	CYPRUS	CRETE /GREECE	SARDINIA
EARLY DYNASTIC: c. 3100-2686 B.C.	CHALCOLITHIC: 4500-3150 B.C.	CHALCOLITHIC: c. 4000-2500 B.C.	FINAL NEOLITHIC: c. 3700-2900 B.C.	
OLD KINGDOM: c. 2686-2181 B.C.	EARLY BRONZE AGE I-II: c. 3150- 2650 B.C.			
FIRST INTERMEDIATE PERIOD: c. 2181- 2055 B.C.	EB III: c. 2650- 2200 B.C.	Philia Culture: c. 2500-2400 B.C.	EARLY BRONZE AGE: c. 2900- 2000 B.C.	
MIDDLE KINGDOM: c. 2055-1650 B.C.	EB IV (EB-MB): 2200-2000 B.C.	EARLY CYPRIOT: c. 2400-2000 B.C.		
SECOND INTERMEDIATE PERIOD: c. 1650- 1550 B.C.	MB IIA: c. 2000- 1750 B.C.	Middle Cypriot I- III: c. 2000-1700 B.C.	Middle Minoan/Middle Helladic c. 2100-1700 B.C.	
NEW KINGDOM: (c. 1550-1069 B.C.) <u>Eighteenth</u> <u>Dynasty</u> : c. 1550- 1295 B.C.	MB IIB: c. 1750- 1550 B.C.	Middle Cypriot III-Late Cypriot I: c. 1700-1400 B.C.	Late Minoan IA/ Late Helladic I c. 1700-1550 B.C.	
(1) Thutmose III: c. 1479-1425 B.C.				
(2) Hatshepsut: c. 1473-1458 B.C.				
(3) Amenhotep II: c. 1427-1400 B.C.				
(4) Thutmose IV: c. 1400-1390				
(5) Amenhotep III: c. 1390-1352				
(6) Akhenaton: c. 1352-1336 B.C.				

<sup>1534</sup> Based on chronologies from Warren (1989), Kitchen (1987; 1991), Shaw and Nicholson (1995), LoSchiano (1986); Giardino 2000b; Steel 2004, 13; and Rothenberg and Glass 1992, 149. In the Egyptian chronology, only the pharaohs mentioned in the text are listed.

<b>EGYPT (New Kingdom Period pharaohs mentioned in text)</b>	<b>APPENDIX 1, LEVANT</b>	<b>continued CYPRUS</b>	<b>CRETE /GREECE</b>	<b>SARDINIA</b>
<u>Nineteenth</u> Dynasty: c. 1295- 1069 B.C.: (1) Ramesses II: c. 1279-1213 B.C.	LB I: c. 1550-1400 B.C.		LM IB/ LH IIA: c. 1550- 1500 B.C.	
<u>Twentieth</u> Dynasty: Ramesses III: c. 1184-1153 B.C.	LB IIA: c. 1400- 1300 B.C.		LM II/ LH IIB: c. 1500-1450 B.C.	PROTO- NURAGIC PERIOD: c. 1500-1200 B.C.
	LB IIB: c. 1300- 1200 B.C.		LM IIIA/ LH IIIA: c. 1450- 1400 B.C.	
	IRON AGE I: c. 1200-1000 B.C.	Late Cypriot II A- C: c. 1400-1200 B.C.	LM III B/ LH III B: c. 1400- 1200 B.C.	
		Late Cypriot IIIA- IIIB: c. 1200-1050 B.C.	LM IIIC/ LH IIIC: c. 1200- 1070 B.C.	Middle Nuragic I/Final Bronze Age: c. 1200-900 B.C.
		Cypro-Geometric I: c. 1050-950 B.C.		

## APPENDIX 2

## LOCATIONS AND CONTEXTS OF COPPER OXHIDE INGOT AND TIN INGOT

FINDS<sup>1535</sup>

<b>Location:</b>	<b>Evidence:</b>	<b>Date:</b>	<b>Source(s):</b>
<b>AEGEAN (Crete)</b>			
Gournia	Four oxhide ingot fragments	LM IB or c. 1500-1450 B.C.	Betancourt <i>et. al.</i> 1978, 7-8; Muhly 1979, 91; Hakulin 2004, 39; Gale and Stos-Gale 1999, 273.
Hagia Triadha	Nineteen Type 1 oxhide ingots in a palace storeroom; One half of a Buchholz Type 2 oxhide ingot; possibly a 'quarter' of a Type 2 ingot	LM IA (?) c. 1600-1550 B.C. Fragmentary ingot(s?) possibly from a later date	Buchholz 1959, 32-4; Rutter 1999, 151, n. 18; Gale 1991, 202; Evely 2000, 343, 345; Stos-Gale and Gale 1990, 79-80.
Khania	Three oxhide ingot fragments	LBA	Gale 1991, 202
Knossos	Oxhide ingot fragment	LMI-II (c. 1600-1400 B.C.)	Buchholz 1959, 31; Gale 1991, 202; Mangou and Ioannu 2000, 208.
Kommos	Six oxhide ingot fragments sourced to Cyprus	MM III-LM I/ LM II-LM III/ c. 1350-1250 B.C.	Shaw 1987; 1995, 390, 398-9; Balthazar 1995; Rutter 1999, 140-1; Muhly <i>et al.</i> 1988, 291-2.
Mochlos	Six bronze hoards containing oxhide ingot fragments; 15 small ingot fragments from Room 2 of Building A found inside two broken bronze bowls	LM IB (c. 1500-1450 B.C.)	Soles and Davaras 1994, 414-9, Pl. 100a; Soles and Davaras 1996, 194, 197, 200-1, Pl. 56.a-b, Fig. 13; Soles <i>et al.</i> 2004, 46-7, Fig. 19); Soles <i>et al.</i> 2004, 45-60

<sup>1535</sup> This is an updated compilation of several earlier catalogs and references to newer discoveries. Major sources include Buchholz 1959; Bass 1967; Begemann *et al.* 2001; Catling 1964; Gale 1991; Knapp 1986; LoSchiavo 1982; 1989; 1998; LoSchiavo *et al.* 1990.

<b>APPENDIX 2, continued</b>			
<b>Location:</b>	<b>Evidence:</b>	<b>Date:</b>	<b>Source(s):</b>
Mochlos	Triangular tin ingot or ingot fragment, found with a bronze trident in Building B.2	LM IB (c. 1500-1450 BC)	Whitley 2005, 102-4; Soles 2005
Mochlos	Intact oxhide ingot found in 'ceremonial center', Building B.2	LM IB (c. 1500-1450 BC)	Whitley 2005, 102.
Mochlos	15 kg oxhide ingot half with incised 'rudder' mark. Found in a metal hoard including copper ingots and bronze objects	LM IB (c. 1500-1450 BC)	Whitley 2005, 102-3.
Palaikastro or Mochlos	Two oxhide ingots from either site	LM	Buchholz 1959, 31; Tylecote 1981; Hakulin 2004, 45
Poros-Katsambas	Complete oxhide ingot	LMIIIA2-LMIIIB	Hakulin 2004, 42; Dimopolou 1997, 433-8
Sitias	Oxhide ingot fragment	LM	Buchholz 1959, 31
Syme	Oxhide ingot fragment	LM	Muhly <i>et. al.</i> 1988, 283; Gale 1991, 202; Mangou and Ioannou 2000, 208-10.
Tylissos	Three Type 1 oxhide ingots	LM I-II (1600-1400 B.C.)	Buchholz 1959, 32; Hazzidakis 1921, 57, Fig. 31; Gale 1991, 202-4, Pl. 2b-c.
Zakros (1)	Six Type 1 oxhide ingots in storeroom; one oxhide ingot fragment (no contextual information)	LM IA (c. 1600-1500 B.C.)	Platon 1971; Bass 1967, 61; Buchholz 1959, 31; Hakulin 2004, 41; Evely 2000, 341.

<b>APPENDIX 2, continued</b>			
<b>Location:</b>	<b>Evidence:</b>	<b>Date:</b>	<b>Source(s):</b>
<b>AEGEAN (Greece)</b>			
Aegina	Oxhide ingot fragment	LBA?	Buchholz 1959, 36, Gale 1991; Primas and Pernicka 1998, 40.
Athens	Possible oxhide ingot ("Existence questionable" according to Buchholz 1959)	LBA?	Buchholz 1959, 36
Ayia Irini (Keos)	Two oxhide ingot fragments associated with metallurgical debris; half oxhide ingot	LM IB/ LH II/ LC II	Cummer and Schofield 1984, 2, 54, 122, 140, Pl. 41; Wiener 1990, 146; Gale 1991, 226; Mangou and Ioannou 2000, 208, 213
Emporio (Chios)	Oxhide ingot fragment	LH IIIC	Hood 1982, 664, Pl. 139, n. 18; Gale 1991, 226
Kyme (Euboea)	Group of nineteen Type 1 oxhide ingots found in the sea (two fragmentary)	16th-15th century B.C.?	Buchholz 1959, 36; Demekopoulou <i>et al.</i> 1998, 37; Buchholz 1959, 36-7, Pl. 5, n.3-4; Bass 1967, 61; Stos-Gale <i>et al.</i> 1997, 112.
Mycenae (1)	Complete oxhide ingot excavated by Tsountas; Oxhide ingot Type 2b	14th century B.C.	Buchholz 1959, 36; Seltman 1974, 4-5; Iakovides 1974, 297; 1982 ) Bass 1967, 61; Wace 1949, 88



<b>APPENDIX 2, continued</b>			
<b>Location:</b>	<b>Evidence:</b>	<b>Date:</b>	<b>Source(s):</b>
Mycenae (2)	Twelve oxhide ingot fragments and one bronze bun ingot in scrap metal hoard (Poros Wall Hoard);	LH IIIB (c. 1340-1200 B.C.)	Wace 1953, 6-7, Pl. 2a; 1959, Stubbings 1979, 296; Gale 1989, 254, Fig. 29.15; 1991, 226; Mangou and Ioannou 2000, 210-1, 215
Mycenae (3)	Oxhide ingot fragment in small bronze hoard	LH IIIB-C	Bass 1967, 61; Mylonas 1962, 406, Pl. 121:2
Nauplion Museum (4)	Oxhide ingot handle fragment	LBA?	Catling 1964, 269; Gale 1991, 226
Salamis	Oxhide ingot fragments	LHIIIB (c. 1200-1190 B.C.)	Enalia 2002
Thebes	Three oxhide ingot fragments	LBA	Mangou and Ioannu 2000, 208; Enalia 2002
Tiryns	Oxhide ingot fragment; two slab ingots (one of bronze)	LBA	Gale 1991; Mangou and Ioannou 2000, 207-8, 210, 215-6
<b>ANATOLIA</b>			
Boğazköy	Oxhide ingot fragment (handle/ear)	14th-13th century B.C.	Buchholz 1959, 30; 1988, 194; Müller-Karpe 2005, 491, Abb. 10
Cape Gelidonya	34 complete oxhide ingots, five half-ingots, 12 ingot corners; 12 complete bun ingots, 9 almost complete bun ingots, bun ingot fragments; 19 slab ingots; bronze scrap, tin	c. 1200 B.C.	Bass 1967, 52-7, 69-83; Muhly et al. 1977; Gale 1999.
Göksu Creek (southeastern Turkey, Şanlıurfa Province)	Two and a half oxhide ingots, two with impressed marks, discovered during dredging operations	LBA—13th century B.C.?	Belli 2004, 31-2; Sertok and Güllüce 2005.

<b>APPENDIX 2, continued</b>			
<b>Location:</b>	<b>Evidence:</b>	<b>Date:</b>	<b>Source(s):</b>
Metropolitan Museum (New York)	Oxhide ingot, thought to come from Anatolia	LBA	Buchholz 1959, 30.
Şarköy (İğdebağları; Northwest shore of the Sea of Marmara)	Cut oxhide ingot corner with 'handle' found in hoard of Mycenaean or Mycenaean-style objects	Late 13th to 11th century B.C.	Harmankaya 1995; Gale and Stos-Gale 1999, 272; Stos-Gale et al. 1997, 112; Lichardus et al. 2002, 165, Abb. 19.3; Jablonka and Rose 2004, 92; Kolb 2004, 592. [Currently on display in the Istanbul Archaeology Museum].
Side (Eski Adalia), Bay of Antalya	Three oxhide ingots found in the sea. Probably part of a larger oxhide ingot cargo of an estimated two tons salvaged in early 20th century	Possibly 15th century B.C.?	Bass 1967, 61; 1986, 272; Buchholz 1959, cat. No. 6, pl. 3:5; Pulak 1997, 235; 1998, 191; 2001, 16; Gale 1991, 201.
Tarsus? (In Ashmolean Museum)	Miniature oxhide ingot	?	Catling 1964, 269, n.3; Knapp 1986, 26
Uluburun	Approx. 9 tons of copper (354 complete two- and four-handled oxhide ingots, oxhide ingot fragments, 121 complete bun ingots, copper oxhide and bun ingot fragments), approx. 1 ton of tin ingots/ ingot fragments	Late 14th century B.C.	Pulak 1997; 1998; 2000; 2001; Bass 1986; 1991; Hauptmann et al. 2002; Maddin 1989; Gale 1999; 2000

<b>APPENDIX 2, continued</b>			
<b>Location:</b>	<b>Evidence:</b>	<b>Date:</b>	<b>Source(s):</b>
<b>BLACK SEA/ BALKANS:</b>			
Černozem (Bulgaria)	Intact oxhide ingot with incised mark	LBA	Lichardus et al. 2002, 160-5, 171-6; Buchholz 2005, 152
Cape Kalliakra (northeast Bulgaria)	Miniature oxhide ingot (approx. dimensions: 25 x 14 x 1.4 cm ) found off Bulgarian coast	LBA?	Hiller 1991, 209-10; Lichardus et al. 2002, 165, Abb. 19.1; Kolb 2004, 593
Makarska? (Croatia)	Miniature oxhide ingot; bought by J. Evans in 1880; no evidence for context or date	LBA?	Buchholz 1959, 37; Bass 1967, 61; Forenbaier 1995, 272; Catling 1964, 269, n.3; Knapp 1986, 26
Tcherkovo (Čerkovo, Bulgaria)	Oxhide ingot	LBA	Hiller 1991, 209-10; Kolb 2004; Höckmann 2003, 136; Stos-Gale et al. 1997. 112 (states that ingot was mistakenly reported as being recovered from the sea); Dimitrov 1979, 73
<b>CORSICA:</b>			
Sant' Anastasia	Type 1 oxhide ingots reportedly found in the sea. Incised mark.	LBA	LoSchiavo 2005, 407-8
<b>CYPRUS:</b>			
<i>Alassa-Pano Mandilaris</i>	Miniature oxhide ingot	LC IIC (c. 1275-1200 B.C.)	Hadjisavvas 1986, 62-7; 1989; 1996

<b>APPENDIX 2, continued</b>			
<b>Location:</b>	<b>Evidence:</b>	<b>Date:</b>	<b>Source(s):</b>
Enkomi ("Foundry Hoard")	Two complete oxhide ingots, ingot fragments from bronze hoards, five miniature ingots; "Ingot God" bronze statue; three more complete oxhide ingots, one miniature ingot, and "Bomford Statuette" possibly from Enkomi	12th century B.C. (excavated examples)	Buchholz 1959, 28-30; Catling 1964, 280; Gale 1991, 200; Knapp 1986; Schaeffer 1952; 1971; Courtois 1971; Catling 1971
Episkopi?	Four-sided stand with oxhide ingot bearer	12th century B.C.?	Catling 1964, 205-6, Pl. 34
Jerusalem Museum	Fragmentary four-sided stand with oxhide ingot bearer	LC IIIA	Karageorghis 2002, 99; Knapp 1986, Pl. 7
Kalavassos <i>Ayios Dhimitrios</i>	Smelting slag, furnace and crucible fragments, tuyeres, oxhide ingot fragments in large ashlar building	LC IIC (13th century B.C.)	South 1980; 1989; South et al. 1989
Kourion- <i>Bamboula</i>	Bronze stand with ingot bearer	12th-11th century B.C.?	Bass 1967, 68-9; Karageorghis 2002, 99
Maa- <i>Palaeokastro</i>	One to three oxhide ingot fragments, pot bellows, tuyere, copper slag, piece of copper ore	LCIIC (end of the 13 <sup>th</sup> century B.C.)	Demas 1984, 151-2; Karageorghis and Demas 1988, 262; Zwicker 1988, 427-31; Muhly and Maddin 1988, 471-2; Gale 1990, 202.
Maroni <i>Vournes</i>	Four oxhide ingot fragments, metal-working debris (slag, furnace conglomerate, casting spillage), scrap bronze	13th century B.C.	Cadogan 1987; 1989; Muhly <i>et al.</i> 1988, 292; Gale 1991, 200.

<b>APPENDIX 2, continued</b>			
<b>Location:</b>	<b>Evidence:</b>	<b>Date:</b>	<b>Source(s):</b>
Mathiati	Oxhide ingot in Nicosia Museum; twenty- seven oxhide ingot fragments from Mathiati Hoard; possible miniature oxhide ingot fragment	LBA	Buchholz 1959, 29; Catling 1964, 266-9; Pl. 49, Pl. 52.b.37; Gale 1991; Muhly et al. 1980; Knapp 1986, 26
<i>Pyla-Kokkinokremos</i>	Slag deposit in pit in courtyard of probable residential area; 'Founder's Hoard' of scrap bronze, including 2-3 oxhide ingot fragments	LCIIC (end of the 13th century B.C.)	Gale and Stos-Gale 1984, 100; Karageorghis and Demas 1984; Muhly and Maddin 1988, 472
Royal Ontario Museum	Half of bronze ingot bearer figure, probably from a Cypriot bronze stand	13th-12th century B.C.	Karageorghis and Pappasavvas 2001; Matthäus 2005, 341
Sinda	Two-sided limestone mold for several types of decorative objects; includes a mold for a possible miniature oxhide ingot	LC?	Buchholz 2003, 125-8, 130
Skouriotissa	Seven oxhide ingot fragments in Nicosia Museum. No contextual information	LBA	Gale 1991, 201; Stos-Gale et al. 1997, 107.
Bay of Soli	Oxhide ingot recovered from the sea	LBA	Bass 1967, 61
Unknown provenience (Cyprus)	Miniature oxhide ingot	LBA	Catling 1964, 269; Knapp 1986, 26; Schaeffer 1952, 30, 47, Fig. 6A
<b>EGYPT:</b>			
Karnak	Oxhide ingots in temple reliefs (2 examples)	Reigns of Amenhotep II (1) and Tuthmosis IV (1) (c. 1436-1411/1411-1397 B.C.)	Bass 1967, 63, 65

<b>APPENDIX 2, continued</b>			
<b>Location:</b>	<b>Evidence:</b>	<b>Date:</b>	<b>Source(s):</b>
Medinet Habu	Temple relief of oxhide ingots among votive offerings to Amon-Re	Reigns of Rammeses II-III (mid-late 13th/ early 12th century BC)	Bass 1967, 67
Qantir (Nile Delta)	Oxhide ingot fragment	13th century B.C.	Gale and Stos-Gale 1999, 272; Pusch 1995, 123
Tell Amarna	Tomb of Meryra I, Meryra II, and Huya, showing oxhide ingots in the Royal Storehouse and ingots brought as tribute by Syrians	Reign of Amenhotep IV (Akhenaton) (c. 1370-1353 B.C.)	Bass 1967, 66-7
Thebes	Four miniature oxhide ingots found in four separate temple foundation deposits at Thebes	Late 13th, early 12th centuries B.C.	Bass 1967, 62; O'Connor 1967, 172-4
Thebes	Tomb painting depicting Syrians and Aegeans carrying oxhide ingots/oxhide ingots represented in piles of tribute, storehouses	Reign of Hatshepsut to reign of Akhenaton or Tutankhamen (c. 1490-1300? B.C.)	Wachsmann 1987; Bass 1967, 62-7; Rehak
<b>FRANCE:</b>			
Coast west of Marseille	Two copper oxhide ingots found in the sea	LBA	Domergue and Rico 2002, 141-52
<b>GERMANY:</b>			
Oberwilflingen (Baden-Württemberg)	Four oxhide ingot fragments in a scrap metal hoard	14th or -early 13th century B.C.	Primas and Pernicka 1998; Primas 2005, 389
<b>MESOPOTAMIA:</b>			
Dur-Kurigalzu	Oxhide ingot found in a possible storeroom/treasury	12th century B.C.	Brinkman 1987, 35; Gale 1991, 200

<b>APPENDIX 2, continued</b>			
<b>Location:</b>	<b>Evidence:</b>	<b>Date:</b>	<b>Source(s):</b>
Nimrud	Possible oxhide ingots (Type 1 'pillow' ingots) depicted in tribute scene from throne dais of Shalmeneser III	Reign of Shalmeneser III (mid-ninth century B.C.)	Mallowan 1966:2, 445-7, Fig. 371a; Moorey 1994, 245
Nimrud	Oxhide ingot bearer (doubtful) on tribute scene	Reign of Assurnasirpal (ninth century B.C.)	Reade 1980, 11, Pl. III; Moorey 1994, 245
<b>SARDINIA<sup>1536</sup>:</b>			
Abini ("Teti hoard")	Oxhide ingot fragment from a looted hoard	LBA?	LoSchiavo 1982, 271; 1989, 34; LoSchiavo et al. 1990, 25
Alghero (Sassari), Nuraghe Flumenelongu	(1) Scrap metal hoard including 32 plano-convex ingots; (2) surface finds of three oxhide ingot fragments	(1) 10th century B.C.; (2) LBA?	LoSchiavo 1989, 36; 1998, 100; LoSchiavo et al. 1990, 33
Arzachena (Sassari), Nuraghe Albucciu	Six oxhide (?) ingot fragments in a scrap hoard found in an impasto pot	End of the Late Bronze Age	LoSchiavo 1982, 271-2; Begemann et al. 2001, 45-6; LoSchiavo et al. 1990, 19
Assemini (Cagliari)	Unknown number of oxhide ingots discovered in 1863	LBA?	LoSchiavo 1982, 271; 1989, 35; LoSchiavo et al. 1990, 31
Belvi' (Nuoro), Ocile	Oxhide ingot fragment; isolated find	LBA?	LoSchiavo 1989, 34; LoSchiavo et al. 1990, 25
Capoterra (Cagliari)	Looted scrap metal hoard; included at least one oxhide ingot fragment	LBA?	LoSchiavo 1989, 35; LoSchiavo et al. 1990, 31
Dorgali (Nuoro), Isalle Valley	Oxhide ingot fragment; isolated find	LBA?	LoSchiavo 1989, 34; LoSchiavo et al. 1990, 23
Fonni (Nuoro), Gremanu	Five oxhide ingot fragments	LBA?	LoSchiavo 1998, 100

<sup>1536</sup> LoSchiavo (2005, 405) includes a map with locations of oxhide ingot finds in Sardinia; this map includes five recent discoveries at Baradili, Ghiramonte (Siniscola), Give Molas (Villasor), Nieddiu (Nurallao), and Talana, with no additional information.

<b>APPENDIX 2, continued</b>			
<b>Location:</b>	<b>Evidence:</b>	<b>Date:</b>	<b>Source(s):</b>
Ittereddu (Sassari), Nuraghe Funtana	Two scrap hoards with (1) eight oxhide and (2) 34 oxhide and bun ingot fragments	LBA?	LoSchiavo 1989, 33-4; Begemann et al. 2001, 47; LoSchiavo et al. 1990, 23; Primas 2005, 388, Abb. 4
Lanusei (Nuoro), Nuraghe Nastasi	Two oxhide ingot fragments found with a miniature bronze shield and Nuragic sherds	LBA?	LoSchiavo 1989, 34; LoSchiavo et al. 1990, 27-9
Nuoro Province	Four oxhide ingot fragments in the Nuoro Museum	LBA?	LoSchiavo 1989, 34; LoSchiavo et al. 1990, 25
Olbia (Sassari), Serra Elvèghes	Twenty-five oxhide ingot fragments in a Nuragic period bowl	LBA	LoSchiavo 1998, 105-7
Ortueri (Nuoro), Funtana 'e Cresia	Two fragments of oxhide ingots found with a copper axe; isolated find	LBA?	LoSchiavo 1989, 34; Stos-Gale and Gale 1992, 333; LoSchiavo et al. 1990, 25
Oschiri, S. Giorgio	Twenty-two oxhide ingot fragments found in a hoard	LBA?	LoSchiavo 1998, 107-8
Ossi (Sassari), Nuragic Village of Sa Mandra 'e Sa Giua	Two scrap metal hoards; second contains copper oxhide ingot fragments	LBA	LoSchiavo 1989, 35-6; Tylecote 1984, 141; LoSchiavo et al. 1990, 21, 33
Ozieri (Sassari), S. Antioco di Bisarcio	Two oxhide ingots (one lost)	LBA?	Bass 1967, 61; LoSchiavo 1989, 33; Vagnetti and LoSchiavo 1982, 271; 1989, 226; LoSchiavo et al. 1990, 21
Ozieri (Sassari), S. Luca	Oxhide ingot fragment in small scrap metal hoard (3 other objects)	LBA?	LoSchiavo 1989, 33; LoSchiavo et al. 1990, 21-3
Pattada (Sassari), Sedda Ottinnera	Hoard with approx. 7.7-9.7 kg of oxhide ingot fragments and tools	11th century B.C.	LoSchiavo 1998, 100-4; Begemann et al. 2001, 48
Perda'e Floris	Oxhide ingot fragments	LBA?	LoSchiavo 1982, 272



<b>APPENDIX 2, continued</b>			
<b>Location:</b>	<b>Evidence:</b>	<b>Date:</b>	<b>Source(s):</b>
Santoni	Oxhide ingot fragment (surface find)	LBA?	Vagnetti and LoSchiavo 1989, 226
Sàrdara (Cagliari), Nuragic village of S. Anastasia, Hut no. 1	Twelve fragments of one or more oxhide ingots	Below ninth-century B.C. pavement; in a Late Bronze Age bowl	LoSchiavo 1989, 35; Vagnetti and LoSchiavo 1989, 226; LoSchiavo et al. 1990, 29-31
Serra Ilixi (Nuoro)	Five complete oxhide ingots	LBA (14th century B.C.?)	Buchholz 1959, 38-9; Bass 1967, 61; LoSchiavo 1982, 271; 1989, 35; LoSchiavo et al. 1990, 29
Soleminis (Cagliari) S' Arenagiu	Four fragments of oxhide ingots; surface find	LBA?	LoSchiavo 1989, 35; Vagnetti and LoSchiavo 1989, 226; LoSchiavo et al. 1990
Sorgano	Seventeen oxhide ingot fragment (no stratigraphic context)	LBA	Buchholz 1959, 39
Tertenia (Nuoro), Nuraghe Nastasi	Two oxhide ingot fragments	LBA	LoSchiavo 1989, 34; LoSchiavo et al. 1990, 29
Tharros (western Sardinia)	Oxhide ingot fragment?	LBA	Buchholz 1959, 39. Possibly mistranslated, according to LoSchiavo (1982, 272)
Triei (Nuoro), Nuraghe Bau Nuraxi	Fragments of at least one oxhide ingot in a scrap metal hoard	LBA?	LoSchiavo 1989, 34; LoSchiavo et al. 1990, 25-7
Villagrande Strisaili (Nuoro), Nuraghe Corte Macceddos	Twelve oxhide ingot fragments from at least two ingots; probable surface finds	LBA?	LoSchiavo 1989, 34; LoSchiavo et al. 1990, 27
Villagrande Strisaili (Nuoro), S' Arcu 'e is Forras	Two oxhide ingot fragments, found among remains of a Bronze Age foundry/sanctuary with copper bun ingot fragments, a lead ingot, and tin scraps	LBA	LoSchiavo 1989, 34; LoSchiavo et al. 1990, 27; Vagnetti and LoSchiavo 1989, 226-7, Fig. 28.4; Valera and Valera 2003, 3; LoSchiavo 2003, 124; Fadda 2003

<b>APPENDIX 2, continued</b>			
<b>Location:</b>	<b>Evidence:</b>	<b>Date:</b>	<b>Source(s):</b>
Villanovaforru (Cagliari), Baccu Simeone	Pot full of oxhide and bun ingot fragments	End of the Late Bronze Age?	LoSchiavo 1989, 35; Stos-Gale and Gale 1992, 330-3; LoSchiavo et al. 1990, 29
<b>SOUTHERN ITALY/ SICILY/ ADRIATIC:</b>			
Cannetello (Sicily)	Oxhide ingot fragment	?	Bass 1967, 61; Buchholz 1959, 37
Lipari (Aeolian Islands)	'Pillow'-shaped oxhide ingot fragments in the Lipari hoard	LBA	Giardino 1992, 307; 2000b, 100-1; LoSchiavo 2001, 137; 2005, 401; Muhly 2005, 508
Modi/Leondari (Troezina, E. of Calabria)	Oxhide ingot fragment	?	Enalia 2002, 73-9
Thapsos (Sicily)	Oxhide ingot fragment	LBA	Vagnetti 1999; Giumlia-Mair 2005, 417; LoSchiavo 2005, 400
<b>SYRIA/LEVANT:</b>			
Ha Hotrim, Israel	Copper oxhide ingot fragments; section of a lead ingot, bronze scrap associated with two stone anchors	c. 1200 B.C.	Wachsmann and Raveh 1984; Gale 1999, 111
Kefar Samir (Israeli coast 1.5 km south of Haifa)	(1) Eight tin bar ingots (one inscribed) and one and a half ovoid tin ingots; (2) five inscribed lead ingots found in association with stone anchors and a New Kingdom Egyptian sickle sword; (3) complete copper oxhide ingot found with stone anchors and five tin ingots	LBA (14th-13th century B.C.)	Raban and Galili 1985, 326-9; Misch-Brandl et al. 1985; Galili <i>et al.</i> 1986, 25, 32-4; Gale 1999, 111; Kassianidou 2003, 113

<b>APPENDIX 2, continued</b>			
<b>Location:</b>	<b>Evidence:</b>	<b>Date:</b>	<b>Source(s):</b>
Ras Ibn Hani, Syria	Limestone oxhide ingot mold with copper droplets in	13th century B.C.	Lagarce et al. 1983; Lagarce 1986; Lagarce and Lagarce 1996; Gale 1989; Craddock et al. 1997; Muhly 2005, 504
Tell Beit Mirsim	Half of a miniature oxhide ingot	c. 1600-1550 B.C.	Albright 1938, 54, Pl. 41, no. 13; Bass 1967, 57; Knapp 1986, 26
Ugarit	2-4 oxhide ingot fragments (unpublished)	?	Muhly 1985b, 46; Bass 1967, 57

## APPENDIX 3

GLOSSARY OF METALLURGICAL TERMS<sup>1537</sup>**Metallurgical Terms:**

**Beneficiation:** The process of pulverizing mined ore into small pieces or powder suitable for roasting and/or smelting. Beneficiation allows for the mechanical removal of some of the *gangue* in the ore.

**Flux:** Material added to a smelt in order to chemically combine with gangue in an ore to form a *slag* separate from the desired metal.

**Gangue:** Inert particles in an ore which must be mechanically and/or chemically separated from the metal in the refining process. The most common gangue materials in copper ores are iron and silica.

**Matte:** An intermediate smelting product produced in the process of refining chalcopyrite ore. Matte contains compounds of copper, sulfur, and iron.

**Oxidizing atmosphere:** An oxygen-rich atmosphere produced in a pyrotechnological operation, typically an open fire or a well-ventilated kiln or furnace.

**Prills:** Small copper globules in a slag matrix. Prills were the finished product of the earliest copper smelting operations, where full separation of metal and slag was not achieved due to insufficiently high temperatures and/or the lack or insufficient use of fluxes.

---

<sup>1537</sup> Definitions are taken from a variety of sources (specific definitions are cited in text), including Forbes 1964, 9:18-20; Coghlan 1975, 27-8; Horne 1982; Harding 2000, 217; Muhly 1973a, 171-2; 1989, 304-9; Rothenberg 1978; 1990, 5, 24, 26, 34-6, 41-5; Tylecote 1981; 1987a, 107-8; Craddock 1995, 146-50, 156, 161, 169; Rapp 1999. Terms for features of oxhide ingots are taken from these

Reducing atmosphere: An oxygen-poor atmosphere produced by the release of carbon monoxide gas inside a relatively closed environment (for example, a smelting furnace or a crucible covered by charcoal).

Roasting: The process of heating copper sulfide or chalcopyrite ore in an *oxidizing atmosphere*. This process of combustion combines sulfur impurities in the ore with oxygen in the air to produce sulfur dioxide gas, which is released into the air and therefore removed from the ore.

Slag: The waste product of a smelting process, consisting of a combination of gangue, fluxes, and other material (charcoal fragments, furnace lining, etc.).

Smelting: The process of refining a metal ore into pure metal through heating in a crucible or furnace and chemically separating gangue from metal.

Tap Slag: Slag that is heated to a free-flowing liquid state during the smelting process. In copper smelting, tap slag is lighter than metallic copper and is separated from the copper by *tapping* through a hole in the furnace. Tap slag is differentiated from *furnace slag* by archaeologists. Furnace slag is much more viscous than tap slag; it does not reach temperatures high enough for the complete separation of copper and slag (copper is obtained from furnace slag in the form of *prills*).

Tuyere: A tube through which a forced draught is transferred from bellows to the inside of a furnace or crucible. Due to the high temperatures involved, tuyeres were usually made partly or entirely of unfired or fired clay; they are frequently found as archaeological remains on metallurgical sites.

### **Features of Copper Ingots:**

Blisters: Blisters are pronounced ‘bubbles’ on the rough surface of the ingot caused by expanding gas escaping from or trapped in the metal during casting. Blisters in copper ingots are usually small (one to two centimeters in diameter, although larger ones occur as well), and can be spherical or irregularly shaped.

Fin: A long, narrow metal formation on the mold surface or side of an ingot, probably the result of molten metal flowing into a crack or damaged area of the ingot mold.

Gas porosities: Pits or holes in the surface of an ingot caused by the escape of gas.

Mold surface/Rough surface: The *mold surface* of an ingot is the bottom surface of an ingot. This surface and the *sides* or thickness of the ingot were in contact with the surfaces of the ingot mold when the ingot was cast.

**Figure 32: Closeup of the mold surface and transverse side of one of the ‘pillow’ ingots from the Uluburun ship (Photo by the author).**



*(Mold surface/Rough surface, continued)* Since ingots were cast in open, one-piece molds, one surface of the ingot was fully exposed to air. This is called the *rough surface*. This surface is distinguishable from the mold surface by its rougher texture, the presence of blisters and other irregularities, and in the case of the Uluburun ingots, often a smaller number of gas porosity holes.

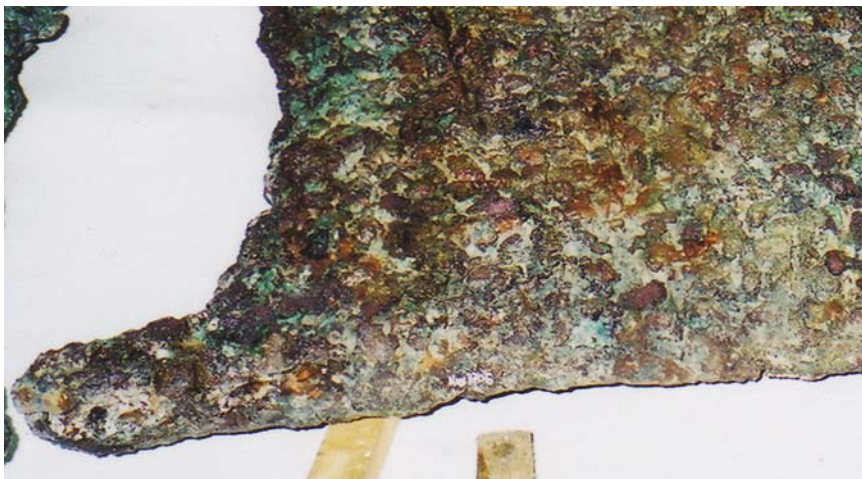

**Figure 33: Closeup of rough surface of two-handled oxhide ingot KW 3706 from the Uluburun ship (photo by the author).**

## VITA

Michael Rice Jones received his Bachelor of Arts in Archaeology from Boston University (*summa cum laude*, Phi Beta Kappa) in May of 2001. He graduated the Nautical Archaeology Program at Texas A&M University in May of 2007. Mr. Jones' archaeological experience includes participation in the underwater excavation of a 16th century shipwreck in the mouth of the Arade River during the summer of 2002, under Dr. Filipe Castro (Texas A&M University), and the continuing excavation and hull recording of four early 11th century Byzantine shipwrecks in the Yenikapı area of Istanbul since July 2005 under Dr. Cemal Pulak of Texas A&M University. Mr. Jones worked in Turkey at the Istanbul Naval Museum on the recording of Kadirga, a 16th century Ottoman sultan's galley during the summers of 2003, 2004, and 2005, as well as at the Bodrum Museum of Underwater Archaeology on metal ingots from the 14th century B.C. Uluburun shipwreck (July-August 2003-2004); both projects were directed by Dr. Cemal Pulak. Mr. Jones worked at Texas A&M's Conservation Research Laboratory (CRL) under Dr. Donny L. Hamilton (September 2002-June 2004) and under Dr. Helen DeWolf (September 2004-June 2005) conserving metal and organic artifacts from the late 17th century submerged site of Port Royal, Jamaica and the late 17th century Belle shipwreck. He has also worked on 17th to 20th century archaeological material from the Spencer/Pierce/Little farm in Newburyport, Massachusetts (September 1999-September 2001), excavated by Dr. Mary Beaudry of Boston University. Mr. Jones may be reached at 97 Washington Park, Newtonville, MA, 02460-1917. His email addresses is [jones444@neo.tamu.edu](mailto:jones444@neo.tamu.edu).